

Cascadable Silicon Bipolar MMIC Amplifier

Technical Data

MSA-0285

Features

- **Cascadable 50 Ω Gain Block**
- **3 dB Bandwidth:**
DC to 2.6 GHz
- **12.0 dB Typical Gain at
1.0 GHz**
- **Unconditionally Stable
($k > 1$)**
- **Low Cost Plastic Package**

Description

The MSA-0285 is a high performance silicon bipolar Monolithic Microwave Integrated Circuit (MMIC) housed in a low cost plastic package. This MMIC is

designed for use as a general purpose 50 Ω gain block. Typical applications include narrow and broad band IF and RF amplifiers in industrial and military applications.

The MSA-series is fabricated using HP's 10 GHz f_T , 25 GHz f_{MAX} , silicon bipolar MMIC process which uses nitride self-alignment, ion implantation, and gold metallization to achieve excellent performance, uniformity and reliability. The use of an external bias resistor for temperature and current stability also allows bias flexibility.

85 Plastic Package

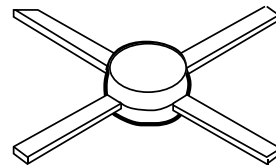

Typical Biasing Configuration

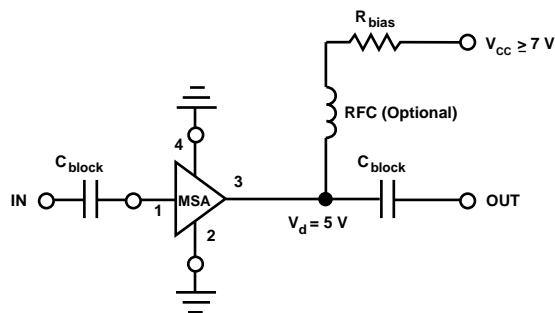

MSA-0285 Absolute Maximum Ratings

Parameter	Absolute Maximum ^[1]
Device Current	60 mA
Power Dissipation ^[2,3]	325 mW
RF Input Power	+13 dBm
Junction Temperature	150°C
Storage Temperature	-65 to 150°C

Thermal Resistance^[2,4]:

$$\theta_{jc} = 95^{\circ}\text{C/W}$$

Notes:

1. Permanent damage may occur if any of these limits are exceeded.
2. $T_{\text{CASE}} = 25^{\circ}\text{C}$.
3. Derate at $10.5 \text{ mW}/^{\circ}\text{C}$ for $T_{\text{C}} > 119^{\circ}\text{C}$.
4. See MEASUREMENTS section “Thermal Resistance” for more information.

Electrical Specifications^[1], $T_{\text{A}} = 25^{\circ}\text{C}$

Symbol	Parameters and Test Conditions: $I_{\text{d}} = 25 \text{ mA}$, $Z_{\text{o}} = 50 \Omega$	Units	Min.	Typ.	Max.
G_{P}	Power Gain ($ S_{21} ^2$) $f = 0.1 \text{ GHz}$ $f = 1.0 \text{ GHz}$	dB	10.0	12.5 12.0	
ΔG_{P}	Gain Flatness $f = 0.1 \text{ to } 1.6 \text{ GHz}$	dB		± 0.6	
$f_{3 \text{ dB}}$	3 dB Bandwidth	GHz		2.6	
VSWR	Input VSWR $f = 0.1 \text{ to } 3.0 \text{ GHz}$			1.3:1	
	Output VSWR $f = 0.1 \text{ to } 3.0 \text{ GHz}$			1.4:1	
NF	50 Ω Noise Figure $f = 1.0 \text{ GHz}$	dB		6.5	
$P_{1 \text{ dB}}$	Output Power at 1 dB Gain Compression $f = 1.0 \text{ GHz}$	dBm		4.5	
IP_3	Third Order Intercept Point $f = 1.0 \text{ GHz}$	dBm		17.0	
t_{D}	Group Delay $f = 1.0 \text{ GHz}$	psec		125	
V_{d}	Device Voltage	V	4.0	5.0	6.0
dV/dT	Device Voltage Temperature Coefficient	mV/ $^{\circ}\text{C}$		-8.0	

Note:

1. The recommended operating current range for this device is 18 to 40 mA. Typical performance as a function of current is on the following page.

MSA-0285 Typical Scattering Parameters ($Z_0 = 50 \Omega$, $T_A = 25^\circ\text{C}$, $I_d = 25 \text{ mA}$)

Freq. GHz	S_{11}		S_{21}			S_{12}			S_{22}	
	Mag	Ang	dB	Mag	Ang	dB	Mag	Ang	Mag	Ang
0.1	.10	174	12.6	4.25	175	-18.6	.118	2	.14	-7
0.2	.10	168	12.5	4.22	171	-18.5	.119	3	.13	-12
0.4	.10	157	12.4	4.17	161	-18.3	.122	6	.14	-26
0.6	.09	143	12.3	4.10	153	-18.3	.121	7	.14	-38
0.8	.08	132	12.1	4.03	144	-18.0	.126	11	.14	-48
1.0	.08	122	11.9	3.95	135	-17.5	.133	12	.14	-60
1.5	.04	95	11.4	3.70	115	-17.0	.142	16	.13	-85
2.0	.02	117	10.6	3.40	95	-16.0	.158	17	.12	-110
2.5	.05	-173	9.9	3.11	82	-15.0	.177	20	.12	-128
3.0	.12	-175	8.9	2.78	65	-14.7	.185	19	.11	-148
3.5	.16	179	7.9	2.49	49	-14.0	.199	14	.10	-145
4.0	.21	169	6.9	2.22	35	-13.7	.207	11	.10	-134
5.0	.28	139	5.0	1.77	9	-13.0	.224	4	.12	-118
6.0	.41	100	3.0	1.42	-16	-12.9	.226	-5	.09	-154

A model for this device is available in the DEVICE MODELS section.

Typical Performance, $T_A = 25^\circ\text{C}$

(unless otherwise noted)

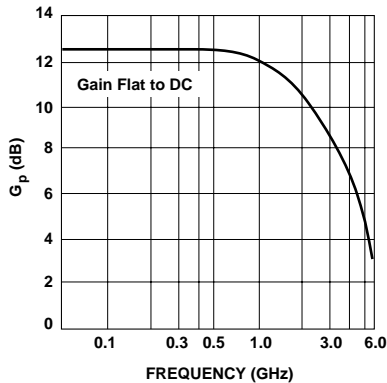

Figure 1. Typical Power Gain vs. Frequency, $T_A = 25^\circ\text{C}$, $I_d = 25 \text{ mA}$.

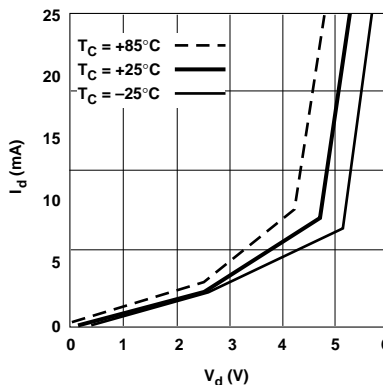

Figure 2. Device Current vs. Voltage.

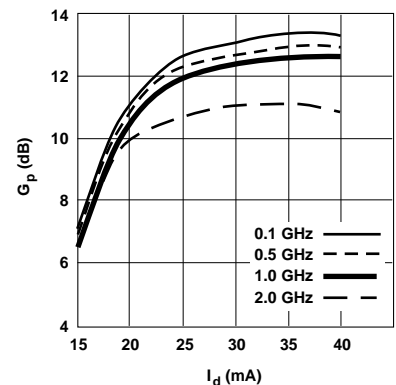

Figure 3. Power Gain vs. Current.

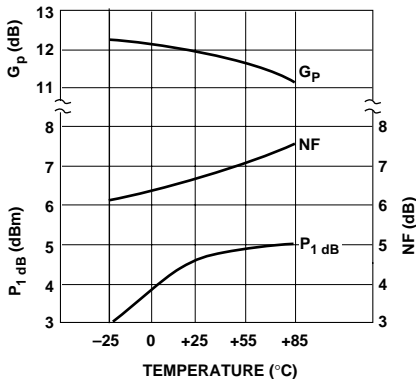

Figure 4. Output Power at 1 dB Gain Compression, NF and Power Gain vs. Case Temperature, $f = 1.0 \text{ GHz}$, $I_d = 25 \text{ mA}$.

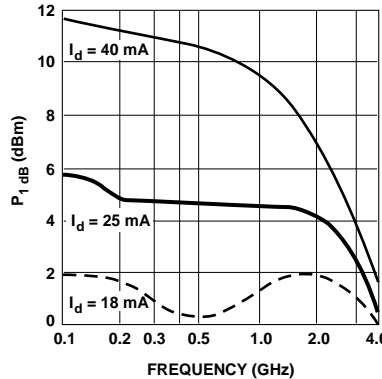

Figure 5. Output Power at 1 dB Gain Compression vs. Frequency.

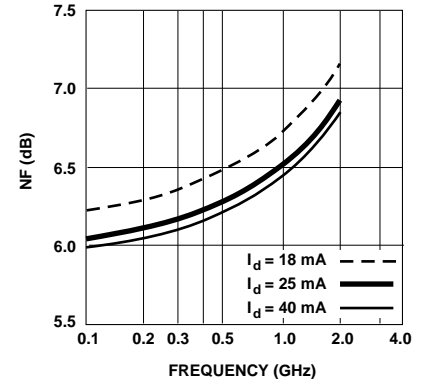

Figure 6. Noise Figure vs. Frequency.

85 Plastic Package Dimensions

