

The PGA-103+ is a monolithic amplifier for the 50-4000 MHz range with excellent Noise Figure and a high dynamic range (1dB compression point: 22.5 dBm and ultra-high OIP3, 44 dBm typ. @ 2GHz).

Due to the intrinsic nature of the GaAs PHEMT, it is not unconditionally stable (stability factor $k > 1$ and stability measure $B > 0$) as $k < 1$ for frequencies under 100MHz.

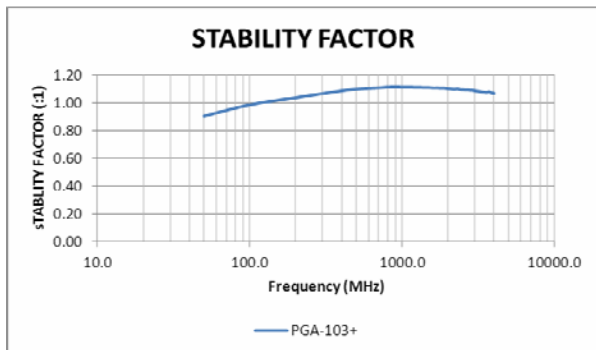
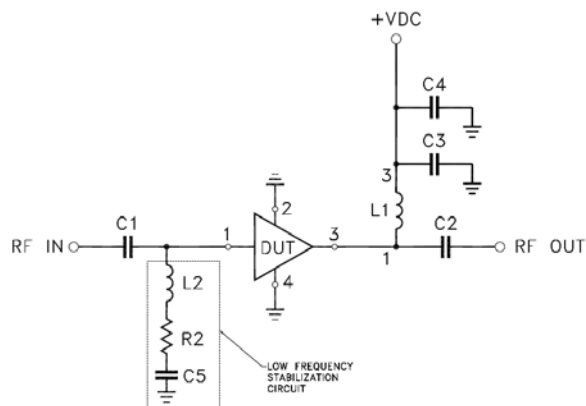

Figure 1 - PGA-103+: stability factor

In order to improve stability additional components need to be added at input, see Figure 2 and associated component values in Table 1.



Component	Value
DUT	PGA-103+
C1,C2	0.01 μ F
C3	0.33 μ F
C4	10 μ F
C5	330 pF
R1	Not Used
R2	150 Ω
L1(RF-Choke)	Mini Circuits TCCH-80+
L2	620nH

Figure 2: Stabilization Circuit (Ref: TB-761-103+)

The stability parameters of the amplifier with the stabilizing network are shown in Figure 3. Note: $k > 1$ and $B > 0$ over entire range.

The performance of the stabilized amplifier:

Performance with and without stabilization is shown in Figures 3 to 11

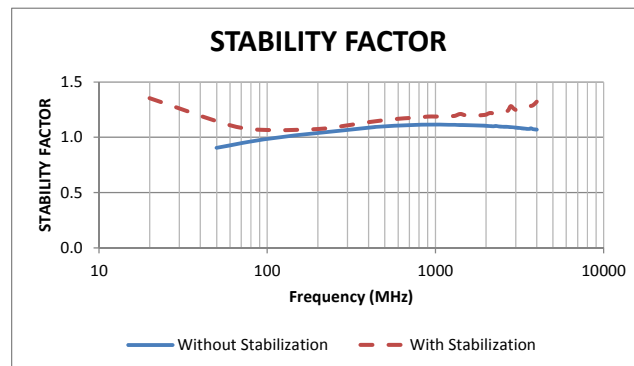

Figure 3 – Stability Factor (k-factor)

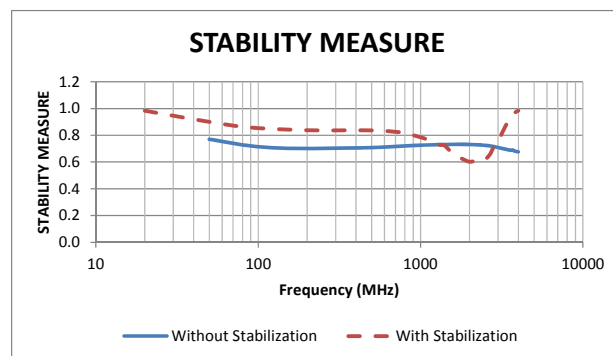

Figure 4 –Stability Measure

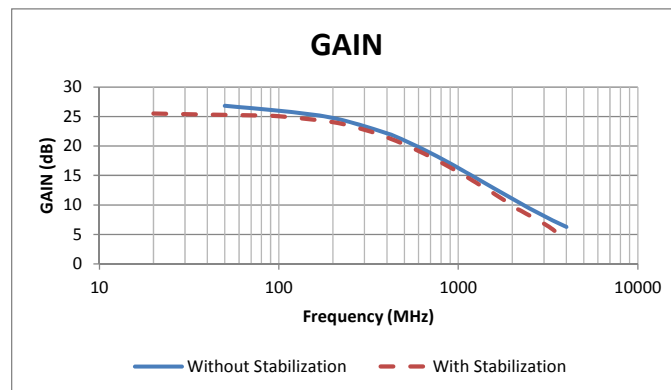

Figure 5 – Gain

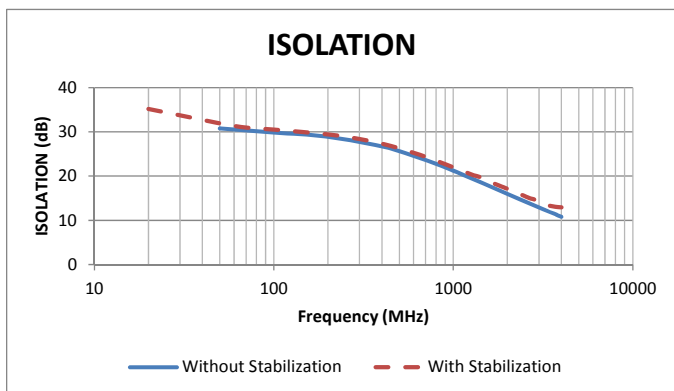

Figure 6 – Isolation

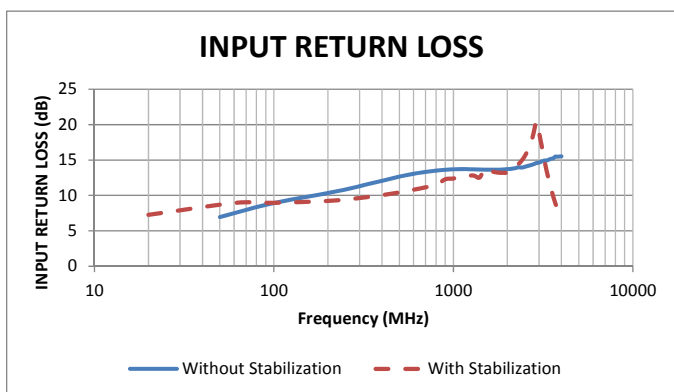

Figure 7 - Input Return Loss

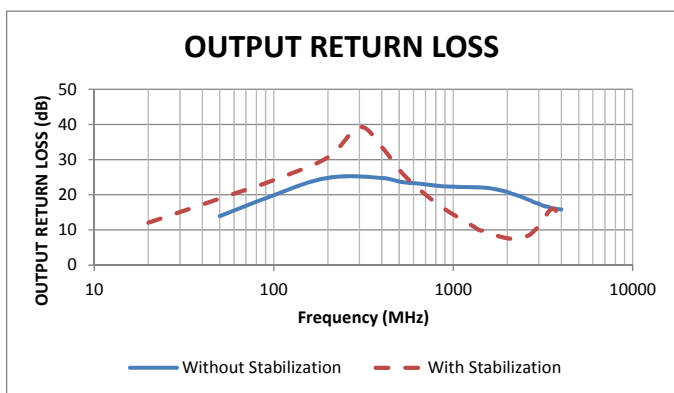

Figure 8 - Output Return Loss

Conclusion:

- Use of the stabilization circuitry has minor impact on all parameters.
- The use of the stabilization circuitry guarantees amplifier’s unconditional stability.

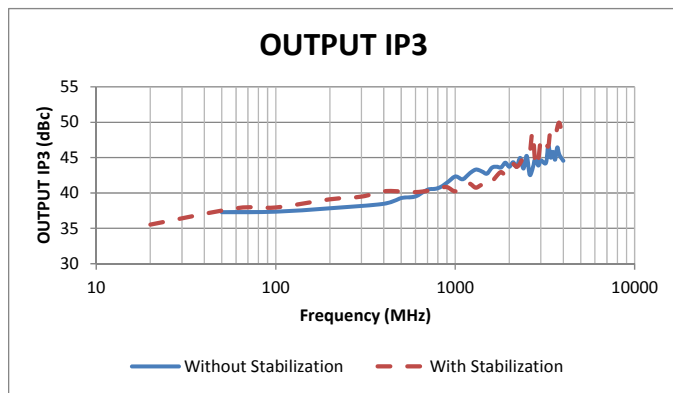

Figure 9 - Output IP3

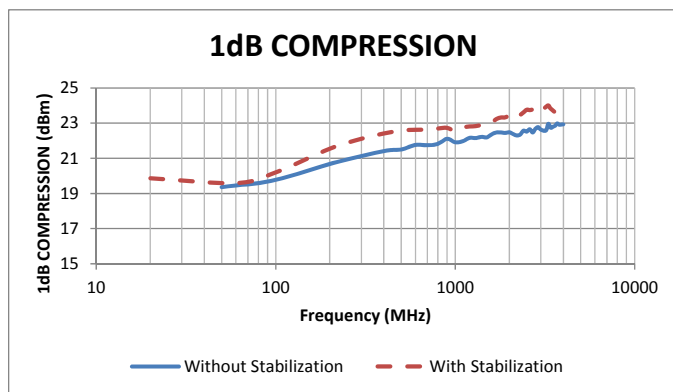

Figure 10 – Output power @ 1dB compression\

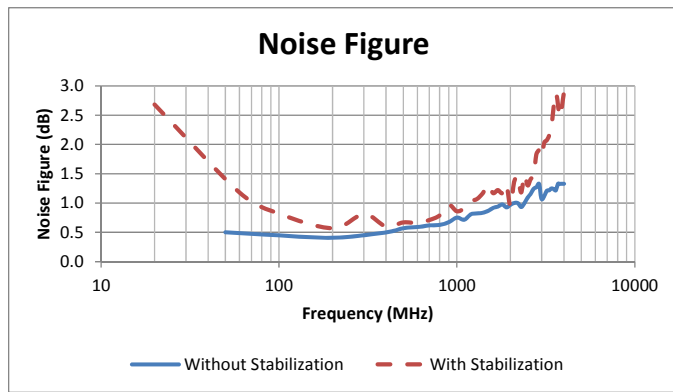

Figure 11 Noise Figure

IMPORTANT NOTICE

© 2015 Mini-Circuits

This document is provided as an accommodation to Mini-Circuits customers in connection with Mini-Circuits parts only. In that regard, this document is for informational and guideline purposes only. Mini-Circuits assumes no responsibility for errors or omissions in this document or for any information contained herein.

Mini-Circuits may change this document or the Mini-Circuits parts referenced herein (collectively, the "Materials") from time to time, without notice. Mini-Circuits makes no commitment to update or correct any of the Materials, and Mini-Circuits shall have no responsibility whatsoever on account of any updates or corrections to the Materials or Mini-Circuits' failure to do so.

Mini-Circuits customers are solely responsible for the products, systems, and applications in which Mini-Circuits parts are incorporated or used. In that regard, customers are responsible for consulting with their own engineers and other appropriate professionals who are familiar with the specific products and systems into which Mini-Circuits' parts are to be incorporated or used so that the proper selection, installation/integration, use and safeguards are made. Accordingly, Mini-Circuits assumes no liability therefor.

In addition, your use of this document and the information contained herein is subject to Mini-Circuits' standard terms of use, which are available at Mini-Circuits' website at www.minicircuits.com/homepage/terms_of_use.html.

Mini-Circuits and the Mini-Circuits logo are registered trademarks of Scientific Components Corporation d/b/a Mini-Circuits. All other third-party trademarks are the property of their respective owners. A reference to any third-party trademark does not constitute or imply any endorsement, affiliation, sponsorship, or recommendation: (i) by Mini-Circuits of such third-party's products, services, processes, or other information; or (ii) by any such third-party of Mini-Circuits or its products, services, processes, or other information.



ISO 9001 ISO 14001 CERTIFIED

P.O. Box 350166, Brooklyn, New York 11235-0003 (718) 934-4500 Fax (718) 332-4661 For detailed performance specs & shopping online see Mini-Circuits web site



The Design Engineers Search Engine Provides ACTUAL Data Instantly From MINI-CIRCUITS At: www.minicircuits.com

RF/IF MICROWAVE COMPONENTS

