

**DATASHEET**

**Electrical & Mechanical Specification**

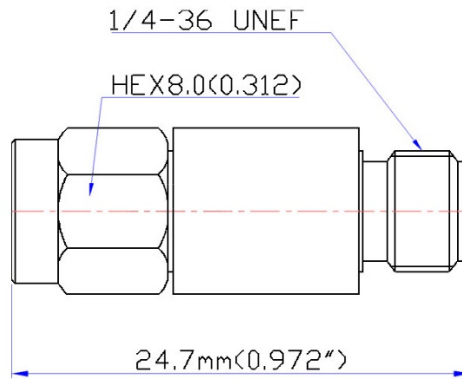

<b>Frequency range</b>	dc - 8 GHz
<b>Attenuation</b>	15 dB (±0.6)
<b>Power handling</b>	2 W (bidirectional)
<b>VSWR</b>	1.20 (max.)
<b>Impedance</b>	50 Ω
<b>Connectors</b>	SMA plug / jack
<b>Body material</b>	Stainless steel
<b>Body finish</b>	Passivated
<b>Center contact</b>	Brass, BeCu / Gold plating
<b>Insulator</b>	PTFE



**Attenuation & Return Loss Vs. Frequency**

