



Series MPT Type

- Quartz, Glass and 'Q' Glass Dielectric
- Sealed and Unsealed Versions
- Panel Mount or Printed Circuit Mounting
- Low Loss
- 0.6pF to 120pF
- 55°C to + 125°C for Glass & 'Q' Glass
-55°C to + 150°C for Quartz Models
- 750V d.c. to 5000V d.c. Working
- Insulation Resistance $10^6 M\Omega$
- Operating Torque 1-10 inch ounces (7.1 - 71mN.m)

The MPT range of trimmers are offered in three types of dielectric material and a number of mechanical mounting configurations to cater for a wide range of requirements. The combination of strictly controlled dielectric thickness and concentricity, coupled with a specially designed adjustment mechanism confer a smooth, positive and uniform tuning torque; this ensures the utmost reliability under extremes of vibrations and shock.

Glass Dielectric

The glass dielectric models with their relatively high K and low dissipation factor will be chosen by the designer for most general purpose applications. The 'Q' glass models will be considered where an extended capacitance range in relatively small size is required.

Quartz Dielectric

The quartz models with their very low dissipation factor and high operating temperature capability are the considered choice for applications involving medium R.F. power. In addition to the wide range of standard modifications available special units can be manufactured which are designated with the prefix SPT. For further information contact our Technical Department.

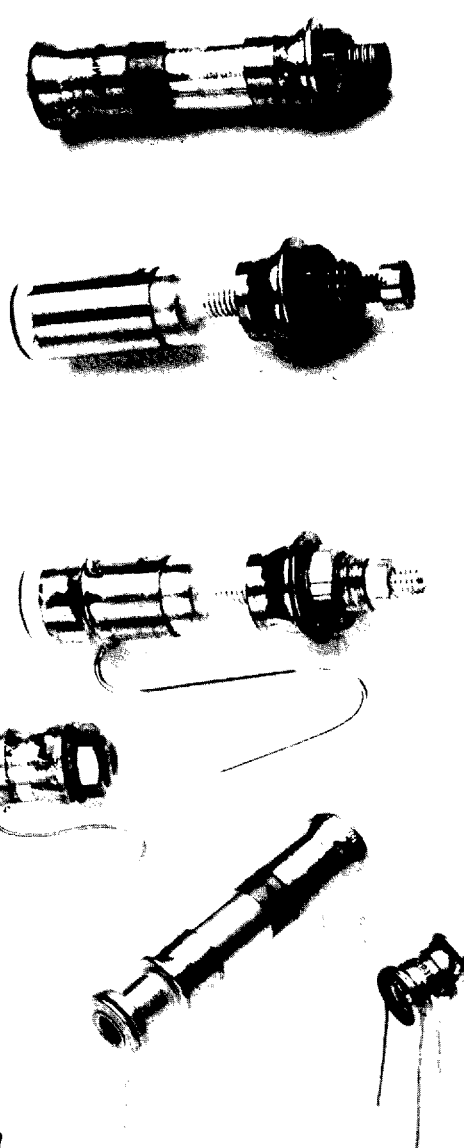

Standard Marking

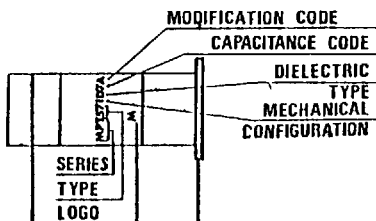

Ordering information

MPT	54	0	2	1	A
Series	Type	Mechanical Configuration	Dielectric Type	Capacitance Range Code	Modification Code
		0- Panel Mount Series 1- Printed Circuit Series 2- Printed Circuit Lug and Lead	0- Glass 1- Quartz 2- "Q" Glass	As Listed in Catalogue each Capacitor Type	see page 66 for list of Modifications

Note: Use Microelectronics adjustment tool M 1001



Series MPT 51

The MPT 51 is widely used for applications where space is at a premium but high resistance to moisture is not required.
For sealed versions see page 63.

Electrical Data - Glass Dielectric

Panel Mount	Printed circuit	Capacitance (pF)		Min 'Q' at 20 MHz	T.C (ppmm/°C -55°C to +125°C)
		Min	Max		
MPT51021A*	MPT51121A	0.8	11.0	900	±50
MPT51022A*	MPT51122A	0.8	5.5	1000	±50
MPT51023A*	MPT51123A	0.8	16.0	800	±100
MPT51024A*	MPT51124A	0.8	23.0	700	±100
MPT51025A*	MPT51125A	1.0	38.0	500	±100
MPT51001A	MPT51101A	0.8	8.5	500	±50
MPT51002A	MPT51102A	0.8	4.5	500	±50
MPT51003A	MPT51103A	0.8	12.0	500	±100
MPT51004A	MPT51104A	0.8	18.0	500	±100
MPT51005A	MPT51105A	1.0	30.0	350	±100

Notes:

1. WVd.c.: 750 V
2. Dielectric Strength: 1500 Vd.c.

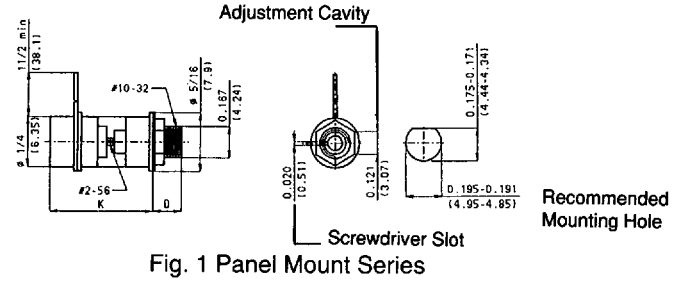

Fig. 1 Panel Mount Series

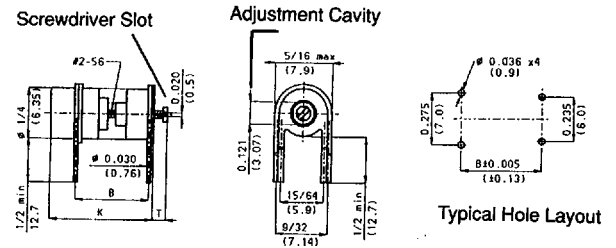

Fig. 2 Printed Circuit 4 Wire Series.

Physical Data for Panel Mount Series - fig. 1

'Q' GLASS	GLASS	K		Lead Wire Diameter	
		in. +3/64 -1/32	mm +1.2 -0.8	AWG.	mm
MPT51021A	MPT51001A	35/64	13.9	22	0.64
MPT51022A	MPT51002A	19/64	7.5	24	0.51
MPT51023A	MPT51003A	3/4	19.0	22	0.64
MPT51024A	MPT51004A	63/64	25.0	22	0.64
MPT51025A	MPT51005A	1 19/32	40.5	22	0.64

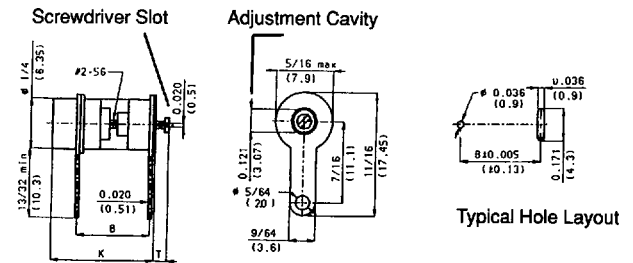

Fig. 3 Printed Circuit Lug and Lead Series.

Physical Data for Printed Circuit Board Series - fig. 2&3

'Q' GLASS	GLASS	B		K		T (max)		Lead Wire Diameter	
		in. ±1/32	mm ±0.8	in. ±1/32	mm ±0.8	in.	mm	AWG.	mm
		MPT51121A*	MPT51101A	7/16	11.1	9/16	14.3	.155	3.90
MPT51122A*	MPT51102A	1/4	6.35	5/16	7.9	.150	3.80	24	0.51
MPT51123A*	MPT51103A	5/8	15.9	49/64	19.4	.200	5.10	22	0.64
MPT51124A*	MPT51104A	7/8	22.2	1	25.4	.180	4.60	22	0.64
MPT51125A*	MPT51105A	1 3/8	34.9	1 39/64	40.9	.165	4.20	22	0.64



Series MPT 54

The increased moisture resistance of the MPT54 together with the high insulation resistance and dielectric strength makes it ideal for defense and aerospace applications.

Electrical Data - Glass Dielectric

Panel Mount	Printed circuit	Capacitance (pF)		Working Voltage D.C	Dielectric Strength V D.C	Min 'Q' at 20 MHz	T.C (ppmm/°C) -55°C to +125°C
		Min	Max				
MPT54021A	MPT54121A	0.8	5.5	750	1500	1000	±50
MPT54022A	MPT54122A	0.8	11.0	1250	2500	900	±50
MPT54023A	MPT54123A	0.8	16.0	1250	2500	800	±100
MPT54024A	MPT54124A	0.8	23.0	1250	2500	700	±100
MPT54025A	MPT54125A	1.0	38.0	1250	2500	500	±100
MPT54001A	MPT54101A	0.8	4.5	750	1500	500	±50
MPT54002A	MPT54102A	0.8	8.5	1250	2500	500	±50
MPT54003A	MPT54103A	0.8	12.0	1250	2500	500	±100
MPT54004A	MPT54104A	0.8	18.0	1250	2500	500	±100
MPT54005A	MPT54105A	1.0	30.0	1250	2500	350	±100

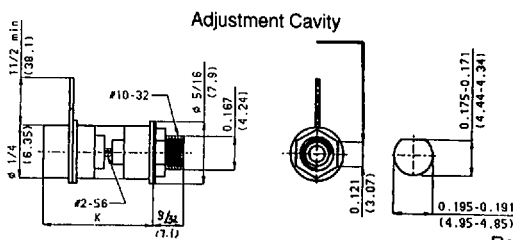

Fig. 4 Panel Mount Series

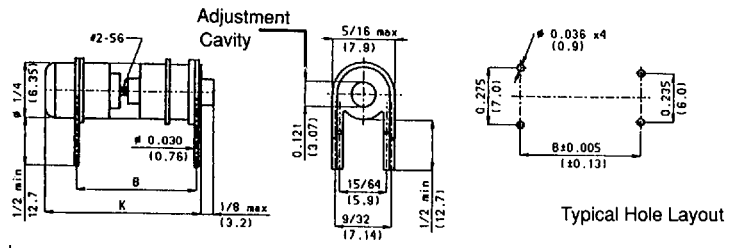

Fig. 5 Printed Circuit 4 Wire Series

Fig. 4 Panel Mount Series

'Q' GLASS	GLASS	K		Lead Wire Diameter	
		in. ±1/32	mm ±0.8	AWG.	mm
MPT54021A	MPT54001A	23/64	9.1	24	0.51
MPT54022A	MPT54002A	19/64	15.0	22	0.64
MPT54023A	MPT54003A	13/16	20.6	22	0.64
MPT54024A	MPT54004A	1 1/16	27.0	22	0.64
MPT54025A	MPT54005A	1 21/32	42.0	22	0.64

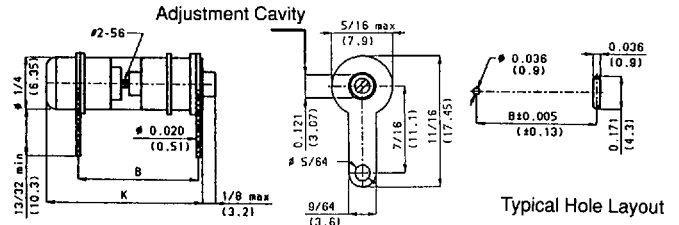

Fig. 6 Printed Circuit Lug and Lead Series

Physical Data for Printed Circuit Board Series - fig. 5&6

'Q' GLASS	GLASS	K		B		Lead Wire Diameter	
		in. ±1/16	mm ±1.6	in. ±1/32	mm ±0.8	AWG.	mm
MPT54121A	MPT54101A	5/8	15.9	1/2	12.7	24	0.51
MPT54122A	MPT54102A	55/64	21.8	45/64	17.85	22	0.64
MPT54123A	MPT54103A	1 5/64	27.4	27/32	21.4	22	0.64
MPT54124A	MPT54104A	1 21/64	33.7	1 1/64	25.8	22	0.64
MPT54125A	MPT54105A	1 59/64	48.8	1 15/32	37.3	22	0.64

Note: Tolerance unless otherwise specified: fractional ± 1/64" (0.4) decimal ± .005 (0.12)

High Capacitance Range Piston Trimmers - Sealed



Series MPT 57

The embedded electrode design coupled with a compact mechanism construction offers the circuit designer a miniature trimmer with a high capacitance range.

Electrical Data

Panel Mount Fig. 1	Printed circuit Fig. 2	Capacitance (pF)		Min 'Q' at 20 MHz
		Min	Max	
MPT57021A	MPT57121A	1.0	16.0	750
MPT57022A	MPT57122A	1.0	36.0	550
MPT57023A	MPT57123A	1.0	52.0	350
MPT57024A	MPT57124A	1.0	75.0	250
MPT57025A	MPT57125A	1.0	120.0	250
MPT57001A	MPT57101A	1.0	14.0	500
MPT57002A	MPT57102A	1.0	28.0	350
MPT57003A	MPT57103A	1.0	42.0	250
MPT57004A	MPT57104A	1.0	60.0	250
MPT57005A	MPT57105A	1.0	90.0	250

Features:

- Glass and High Q Glass Dielectric
- Working Voltage:** 1000V d.c.
- Dielectric Test Voltage:** 2000V d.c.
- T.C. $\pm 50\text{ppm}/^\circ\text{C}$

Fig. 1 Panel mount series

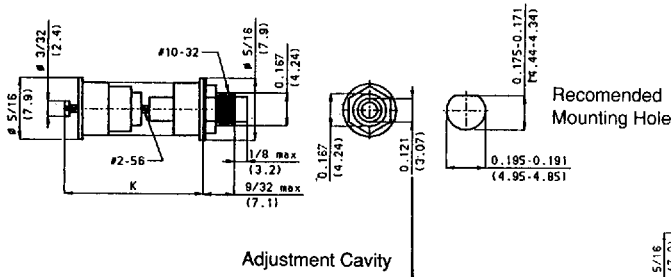
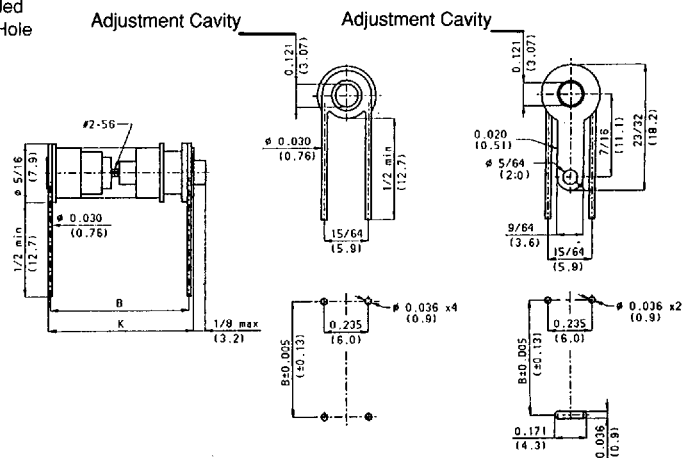

Fig. 2 Printed circuit 4 wire series



Panel Mount Series Physical Data Printed Circuit Series Physical Data

Printed Circuit
2 Wire & Lug Series

Reference		K		Reference		K		B	
'Q' GLASS	GLASS	in. $\pm 1/32$	mm ± 0.8	'Q' GLASS	GLASS	in. $\pm 1/32$	mm ± 0.8	in. $\pm 1/32$	mm ± 0.8
MPT57021A	MPT57001A	15/32	11.9	MPT57121A	MPT57101A	.750	19.0	.700	17.8
MPT57022A	MPT57002A	45/64	17.8	MPT57122A	MPT57102A	.990	25.1	.940	23.9
MPT57023A	MPT57003A	59/64	23.4	MPT57123A	MPT57103A	1.205	30.6	1.155	29.3
MPT57024A	MPT57004A	1 11/64	29.7	MPT57124A	MPT57104A	1.450	36.8	1.400	35.5
MPT57025A	MPT57005A	1 49/64	44.8	MPT57125A	MPT57105A	2.050	52.0	2.000	50.8



Series MPT 59 & 64

Series MPT 59

PANEL MOUNT						
Glass Type	Model	Capacitance (pF)		Min 'Q' at 20 MHz	K	
		Min	Max		in. ±1/32	mm ±0.8
GLASS	MPT59001A	1.0	10.0	500	17/64	6.7
'Q' GLASS	MPT59002A	1.2	16.0	1000	5/16	7.9
PRINTED CIRCUIT						
GLASS	MPT59101A	1.0	10.0	500	17/64	6.7
'Q' GLASS	MPT59102A	1.2	16.0	1000	5/16	7.9

Features:

Glass and High 'Q' Glass Dielectric
Working Voltage : 500V d.c.
Dielectric Test Voltage: 1000V d.c.
 T.C. +75 ±75 ppm/°C

Panel mount Series

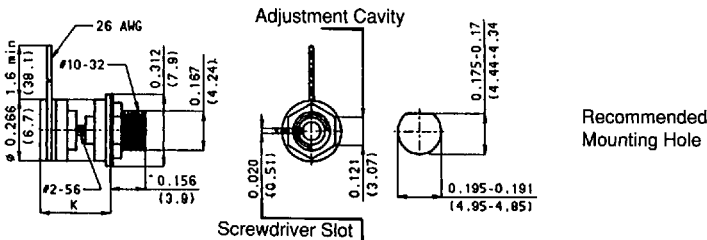

Recommended Mounting Hole

Printed circuit 4 Wire Series

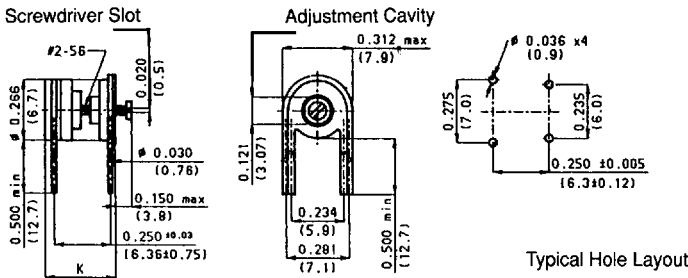

Typical Hole Layout

Series MPT 64011A High D.C. Voltage Quartz Piston Trimmer

For use in applications where extremes of temperature and very high d.c. working voltages are encountered.

0.8pF to 10pF
Working Voltage: 5000V d.c.
Dielectric Test Voltage: 10000V d.c.
 'Q' 1500 min. at 20 MHz
Insulation Resistance: 10⁶ megohms.
 Temp. Coeff. +25 ± 25ppm/°C
 - 55°C to +150 °C - Operating temperature
Tuning Torque: 1-10 inch ounces
 (7.1-71mN.m)

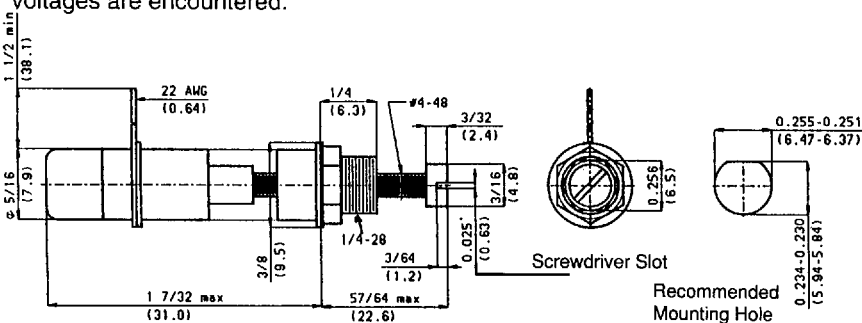

Recommended Mounting Hole

Note: All dimensions are in inches (mm) Tolerances unless otherwise specified:
 fractional ± 1/64 (0.4) decimal ±.005(0.12) For ordering information see page 61



Series MPT

Listed below are some of the options available on the MPT series. Prior to ordering it is advisable to contact our Technical Department to ensure that the most suitable trimmer for your application has been selected. When more than one option is required per unit an SPT reference will be specified.

A - Standard type.

B - At present, there are adaptors for miniature Hi-C series. The adaptors can be interchanged to obtain various decreased dimensions between the electrode and mounting panel ("K" dimensions)

E - Additional lead at base end of panel mount units.

F - Dumet lead, gold plated nickel alloy for weldability, replaces standard lead on panel mount units and all leads on printed circuits units.

G - "D" hole flat washer for use where no "D" hole punching equipment is available enables mounting of panel mount units in round mounting hole. Second hole enables anchoring of the washer.

K - Hi-temp solder on upper lead connection.

M - Lug replacing lead at electrode end of capacitor with dimensions as shown. Attachment portion to capacitor body will vary according to diameter of capacitor concerned.

N - No hardware provided on capacitor.

P - No leads provided on capacitor.

Q - Ribbon lead replacing standard lead.

R - Screw driver slot provided on sealed capacitors.

S - Turret cap replacing standard lead (sealed construction recommended). This construction is recommended where a low-inductance lead is required. For other turret caps contact our Technical Department.

Custom design -
Special trimmers designed for a specific application can be manufactured on request.
Please contact our Technical Department.

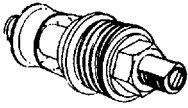
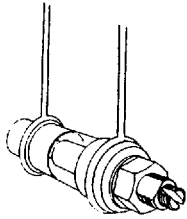
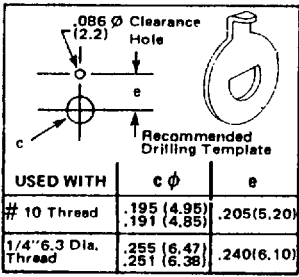
USED WITH	c ϕ	e
# 10 Thread	.195 (4.95) .191 (4.85)	.205 (5.20)
1/4" 6.3 Dia. Thread	.255 (6.47) .251 (6.38)	.240 (6.10)

