

TLE2071, TLE2071A, TLE2071Y EXCALIBUR LOW-NOISE HIGH-SPEED JFET-INPUT OPERATIONAL AMPLIFIERS

SLOS119A – JUNE 1993 – REVISED AUGUST 1994

- 40-V/ μ s Slew Rate Typ
- Low Noise
17 nV/ $\sqrt{\text{Hz}}$ Max at $f = 10$ kHz
11.6 nV/ $\sqrt{\text{Hz}}$ Typ at $f = 10$ kHz
- High Gain-Bandwidth Product . . . 10 MHz
- ± 30 -mA Minimum Short-Circuit Output Current
- Wide Supply Range . . . ± 2.25 V to ± 19 V
- Input Range Includes the Positive Supply
- Macromodel Included
- Fast Settling Time Using 10-V Step
400 ns to 10 mV Typ
1.5 μ s to 1 mV Typ

EQUIVALENT INPUT NOISE VOLTAGE
VS
FREQUENCY

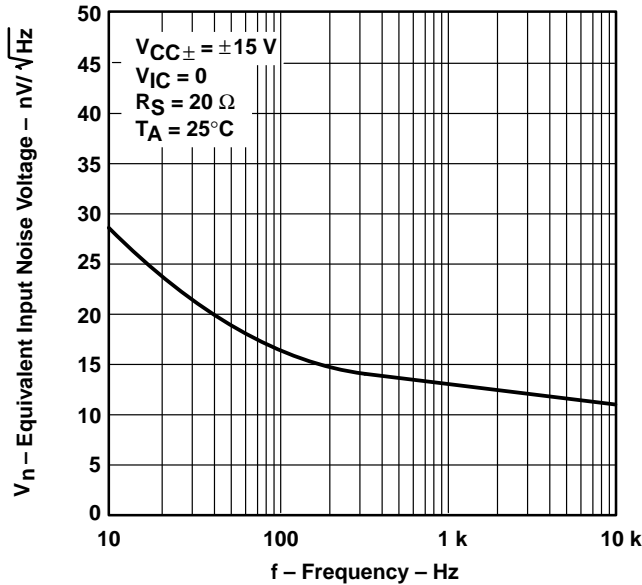

GAIN-BANDWIDTH PRODUCT
VS
FREE-AIR TEMPERATURE

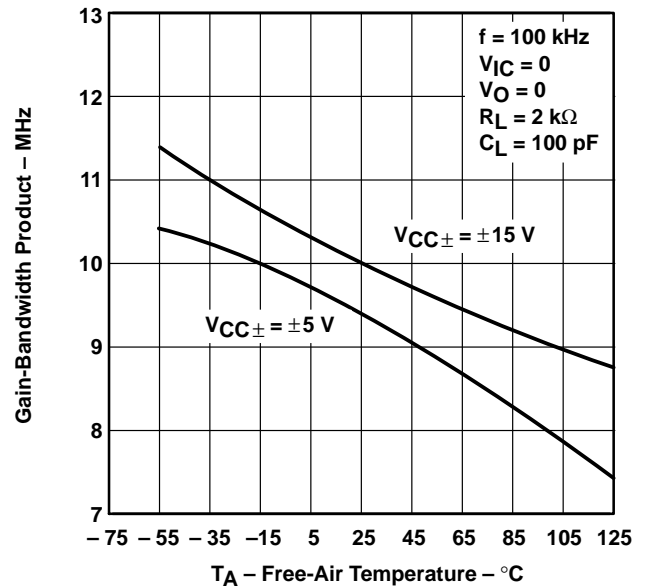

description

The TLE2071 and TLE2071A are low-noise, high-performance, high-speed, internally compensated JFET-input operational amplifiers built using Texas Instruments complementary bipolar Excalibur process. The TLE2071 and TLE2071A have maximum noise specifications for designs requiring certain noise limitations. Both are pin-compatible upgrades to standard industry products.

AVAILABLE OPTIONS

T _A	V _{IO} max AT 25°C	PACKAGED DEVICES				CHIP FORM (Y)
		SMALL OUTLINE (D)	CHIP CARRIER (FK)	CERAMIC DIP (JG)	PLASTIC DIP (P)	
0°C to 70°C	2 mV	TLE2071ACD	—	—	TLE2071ACP	—
	4 mV	TLE2071CD	—	—	TLE2071CP	TLE2071Y
-40°C to 85°C	2 mV	TLE2071AID	—	—	TLE2071AIP	—
	4 mV	TLE2071ID	—	—	TLE2071IP	—
-55°C to 125°C	2 mV	—	TLE2071AMFK	TLE2071AMJG	—	—
	4 mV	—	TLE2071MFK	TLE2071MJG	—	—

The D packages are available taped and reeled. Add R suffix to device type (e.g., TLE2071ACDR). Chip-form versions are tested at T_A = 25°C. For chip-form orders, contact your local TI sales office.

PRODUCTION DATA information is current as of publication date. Products conform to specifications per the terms of Texas Instruments standard warranty. Production processing does not necessarily include testing of all parameters.



POST OFFICE BOX 655303 • DALLAS, TEXAS 75265

Copyright © 1994, Texas Instruments Incorporated
On products compliant to MIL-STD-883, Class B, all parameters are tested unless otherwise noted. On all other products, production processing does not necessarily include testing of all parameters.

TLE2071, TLE2071A, TLE2071Y

EXCALIBUR LOW-NOISE HIGH-SPEED

JFET-INPUT OPERATIONAL AMPLIFIERS

SLOS119A – JUNE 1993 – REVISED AUGUST 1994

description (continued)

The design features a 30-V/ μ s minimum slew rate, which results in a high-power bandwidth. A low audio-band noise of 28 nV/ $\sqrt{\text{Hz}}$ is typical with a 55 nV/ $\sqrt{\text{Hz}}$ maximum at 10 Hz. Settling time to 0.1% of a 10-V step (1-k Ω /100-pF load) is approximately 400 ns. Gain-bandwidth product is typically 10 MHz with an 8 MHz minimum. As such, the TLE2071 and TLE2071A offer significant speed and noise advantages at a low 1.7-mA typical supply current.

The input current characteristics traditionally associated with JFET-input amplifiers have been maintained. Input offset voltage is graded to a 4 mV and 2 mV maximum for the TLE2071 and TLE2071A, respectively. Typically, temperature coefficient of input offset voltage is 3.2 μ V/ $^{\circ}$ C and typical CMRR and k_{SVR} are 98 dB and 99 dB, respectively. Device performance is relatively independent of supply voltage over the wide ± 2.25 -V to ± 19 -V range. The input common-mode voltage range extends from the positive supply down to $V_{CC-} + 4$ V without significant degradation to dynamic performance. Maximum peak output voltage swing is from $V_{CC+} - 1$ V to $V_{CC-} + 1$ V under light loading conditions. The output is capable of sourcing and sinking currents to at least 30 mA and can sustain shorts to either supply. Care must be taken to ensure that maximum power dissipation is not exceeded.

Both the TLE2071 and TLE2071A are available in a wide variety of packages, including both the industry-standard 8-pin small-outline version and chip form for high-density system applications. The C-suffix devices are characterized for operation from 0 $^{\circ}$ C to 70 $^{\circ}$ C, the I-suffix devices over the -40 $^{\circ}$ C to 85 $^{\circ}$ C range, and the M-suffix devices over the full military temperature range of -55 $^{\circ}$ C to 125 $^{\circ}$ C.

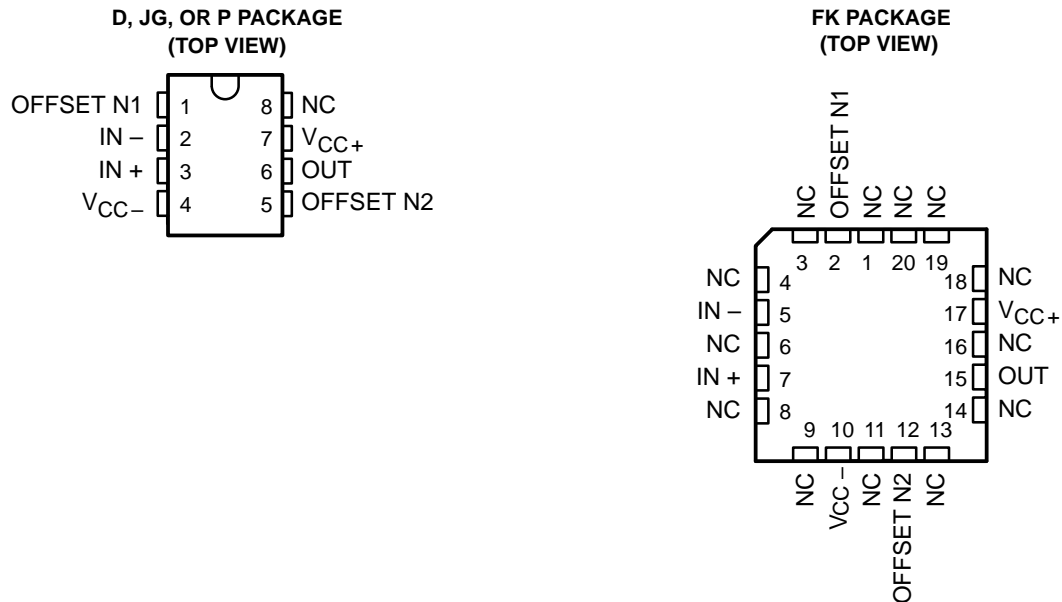

NC – No internal connection

symbol

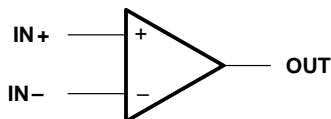

TLE2071, TLE2071A, TLE2071Y
 EXCALIBUR LOW-NOISE HIGH-SPEED
 JFET-INPUT OPERATIONAL AMPLIFIERS

SLOS119A – JUNE 1993 – REVISED AUGUST 1994

TLE2071Y chip information

This chip, when properly assembled, displays characteristics similar to the TLE2071. Thermal compression or ultrasonic bonding may be used on the doped-aluminum bonding pads. Chips may be mounted with conductive epoxy or a gold-silicon preform.

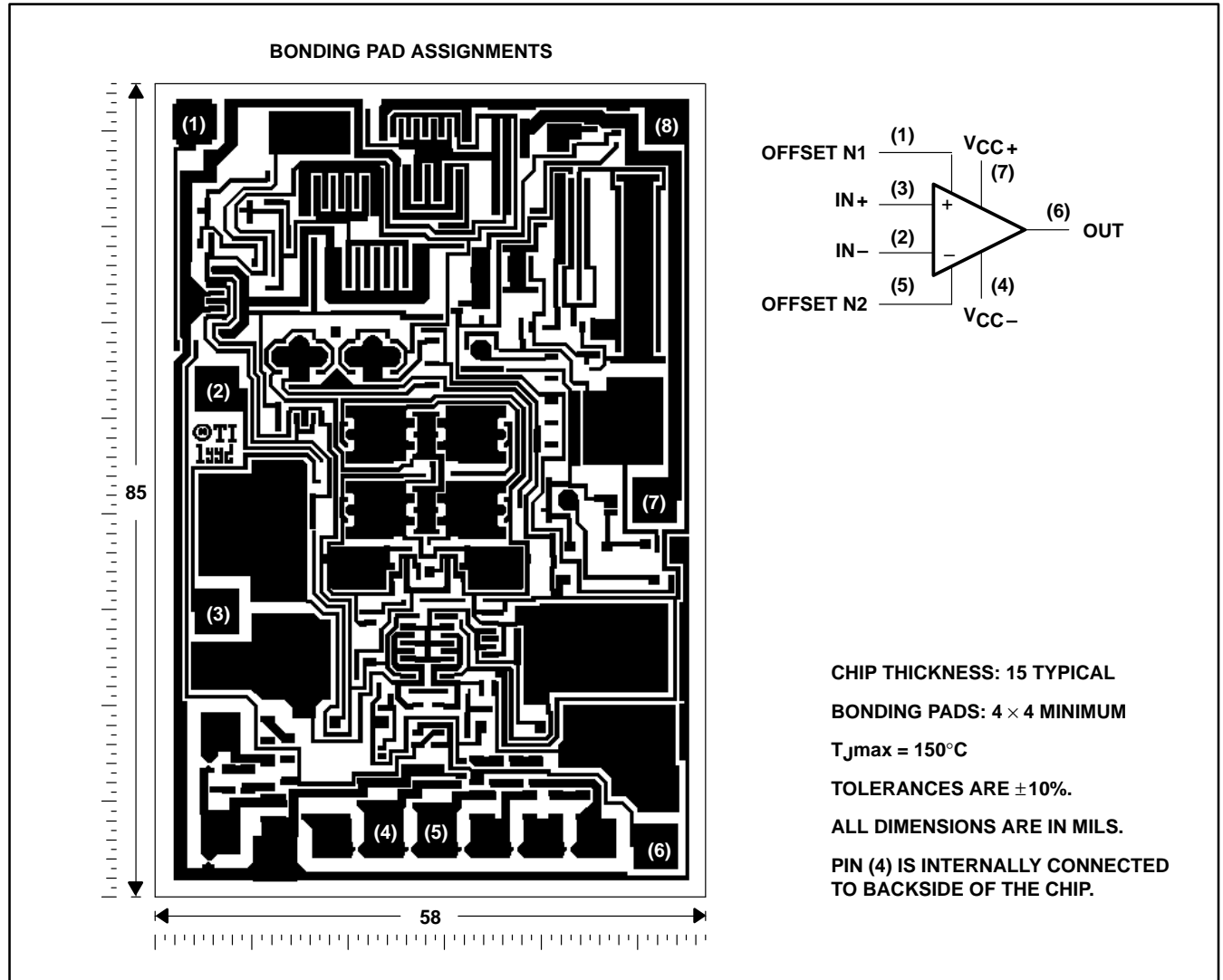

TLE2071, TLE2071A, TLE2071Y
 EXCALIBUR LOW-NOISE HIGH-SPEED
 JFET-INPUT OPERATIONAL AMPLIFIERS
 SLOS119A – JUNE 1993 – REVISED AUGUST 1994

ACTUAL DEVICE COMPONENT COUNT	
Transistors	33
Resistors	25
Diodes	8
Capacitors	6

equivalent schematic

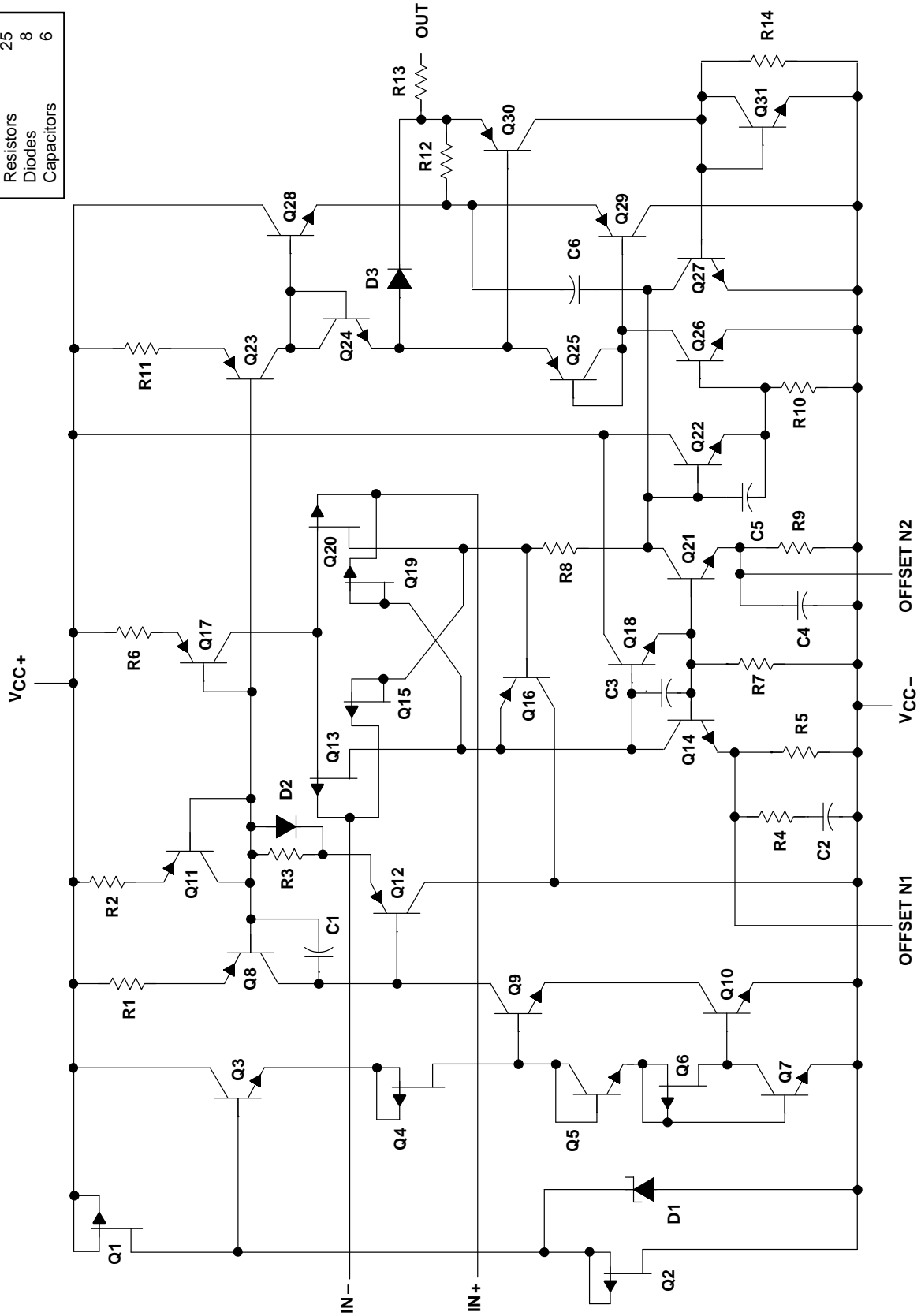

absolute maximum ratings over operating free-air temperature range (unless otherwise noted)†

Supply voltage, V_{CC+} (see Note 1)	19 V
Supply voltage, V_{CC-} (see Note 1)	–19 V
Differential input voltage range, V_{ID} (see Note 2)	V_{CC+} to V_{CC-}
Input voltage range, V_I (any input)	V_{CC+} to V_{CC-}
Input current, I_I (each input)	±1 mA
Output current, I_O (each output)	±80 mA
Total current into V_{CC+}	160 mA
Total current out of V_{CC-}	160 mA
Duration of short-circuit current at (or below) 25°C (see Note 3)	unlimited
Continuous total dissipation	See Dissipation Rating Table
Operating free-air temperature range, T_A : C suffix	0°C to 70°C
I suffix	–40°C to 85°C
M suffix	–55°C to 125°C
Storage temperature range	–65°C to 150°C
Case temperature for 60 seconds: FK package	260°C
Lead temperature 1,6 mm (1/16 inch) from case for 10 seconds: D or P package	260°C
Lead temperature 1,6 mm (1/16 inch) from case for 60 seconds: JG package	300°C

† Stresses beyond those listed under “absolute maximum ratings” may cause permanent damage to the device. These are stress ratings only, and functional operation of the device at these or any other conditions beyond those indicated under “recommended operating conditions” is not implied. Exposure to absolute-maximum-rated conditions for extended periods may affect device reliability.

- NOTES: 1. All voltage values except differential voltages are with respect to the midpoint between V_{CC+} and V_{CC-} .
 2. Differential voltages are at $IN+$ with respect to $IN-$.
 3. The output can be shorted to either supply. Temperatures and/or supply voltages must be limited to ensure that the maximum dissipation rate is not exceeded.

DISSIPATION RATING TABLE

PACKAGE	$T_A \leq 25^\circ\text{C}$	DERATING FACTOR ABOVE $T_A = 25^\circ\text{C}$	$T_A = 70^\circ\text{C}$	$T_A = 85^\circ\text{C}$	$T_A = 125^\circ\text{C}$
	POWER RATING		POWER RATING	POWER RATING	POWER RATING
D	725 mW	5.8 mW/°C	464 mW	377 mW	145 mW
FK	1375 mW	11.0 mW/°C	880 mW	715 mW	275 mW
JG	1050 mW	8.4 mW/°C	672 mW	546 mW	210 mW
P	1000 mW	8.0 mW/°C	640 mW	344 mW	200 mW

recommended operating conditions

	C SUFFIX		I SUFFIX		M SUFFIX		UNIT
	MIN	MAX	MIN	MAX	MIN	MAX	
Supply voltage, $V_{CC\pm}$	±2.25	±19	±2.25	±19	±2.25	±19	V
Common-mode input voltage, V_{IC}	$V_{CC\pm} = \pm 5\text{ V}$		–0.9	5	–0.8	5	V
	$V_{CC\pm} = \pm 15\text{ V}$		–10.9	15	–10.8	15	
Operating free-air temperature, T_A	0	70	–40	85	–55	125	°C

TLE2071, TLE2071A, TLE2071Y
EXCALIBUR LOW-NOISE HIGH-SPEED
JFET-INPUT OPERATIONAL AMPLIFIERS

SLOS119A – JUNE 1993 – REVISED AUGUST 1994

electrical characteristics at specified free-air temperature, $V_{CC\pm} = \pm 5$ V (unless otherwise noted)

PARAMETER	TEST CONDITIONS	T_A †	TLE2071C			TLE2071AC			UNIT	
			MIN	TYP	MAX	MIN	TYP	MAX		
V_{IO} Input offset voltage	$V_{IC} = 0, V_O = 0, R_S = 50 \Omega$	25°C	0.34	4		0.3	2	mV		
		Full range			6		4			
α_{VIO} Temperature coefficient of input offset voltage		Full range	3.2	29		3.2	29	$\mu V/^\circ C$		
I_{IO} Input offset current	$V_{IC} = 0, V_O = 0, \text{See Figure 4}$	25°C	5	100		5	100	pA		
		Full range		1.4		1.4		nA		
I_{IB} Input bias current		25°C	15	175		15	175	pA		
		Full range		5		5		nA		
V_{ICR} Common-mode input voltage range	$R_S = 50 \Omega$	25°C	5 to -1	5 to -1.9		5 to -1	5 to -1.9	V		
		Full range	5 to -0.9		5 to -0.9					
V_{OM+} Maximum positive peak output voltage swing	$I_O = -200 \mu A$	25°C	3.8	4.1		3.8	4.1	V		
		Full range	3.7		3.7					
	$I_O = -2 \text{ mA}$	25°C	3.5	3.9		3.5	3.9			
		Full range	3.4		3.4					
	$I_O = -20 \text{ mA}$	25°C	1.5	2.3		1.5	2.3			
		Full range	1.5		1.5					
V_{OM-} Maximum negative peak output voltage swing	$I_O = 200 \mu A$	25°C	-3.5	-4.2		-3.5	-4.2	V		
		Full range	-3.4		-3.4					
	$I_O = 2 \text{ mA}$	25°C	-3.7	-4.1		-3.7	-4.1			
		Full range	-3.6		-3.6					
	$I_O = 20 \text{ mA}$	25°C	-1.5	-2.4		-1.5	-2.4			
		Full range	-1.5		-1.5					
A_{VD} Large-signal differential voltage amplification	$V_O = \pm 2.3 \text{ V}$	$R_L = 600 \Omega$	25°C	80	91		80	91	dB	
			Full range	79		79				
		$R_L = 2 \text{ k}\Omega$	25°C	90	100		90	100		
			Full range	89		89				
		$R_L = 10 \text{ k}\Omega$	25°C	95	106		95	106		
			Full range	94		94				
r_i Input resistance	$V_{IC} = 0$	25°C	10^{12}			10^{12}			Ω	
c_i Input capacitance	$V_{IC} = 0, \text{See Figure 5}$	Common mode	25°C	11			11			pF
		Differential	25°C	2.5			2.5			
z_o Open-loop output impedance	$f = 1 \text{ MHz}$	25°C	80			80			Ω	
CMRR Common-mode rejection ratio	$V_{IC} = V_{ICRmin}, V_O = 0, R_S = 50 \Omega$	25°C	70	89		70	89	dB		
		Full range	68		68					
k_{SVR} Supply-voltage rejection ratio ($\Delta V_{CC\pm} / \Delta V_{IO}$)	$V_{CC\pm} = \pm 5 \text{ V to } \pm 15 \text{ V}, V_O = 0, R_S = 50 \Omega$	25°C	82	99		82	99	dB		
		Full range	80		80					

† Full range is 0°C to 70°C.



TLE2071, TLE2071A, TLE2071Y
EXCALIBUR LOW-NOISE HIGH-SPEED
JFET-INPUT OPERATIONAL AMPLIFIERS

SLOS119A – JUNE 1993 – REVISED AUGUST 1994

electrical characteristics at specified free-air temperature, $V_{CC\pm} = \pm 5$ V (unless otherwise noted)
(continued)

PARAMETER	TEST CONDITIONS	T_A †	TLE2071C			TLE2071AC			UNIT
			MIN	TYP	MAX	MIN	TYP	MAX	
I_{CC} Supply current	$V_O = 0$, No load	25°C	1.35	1.6	2.2	1.35	1.6	2.2	mA
		Full range	2.2			2.2			
I_{OS} Short-circuit output current	$V_O = 0$	$V_{ID} = 1$ V	–35			–35			mA
		$V_{ID} = -1$ V	45			45			

operating characteristics at specified free-air temperature, $V_{CC\pm} = \pm 5$ V

PARAMETER	TEST CONDITIONS	T_A †	TLE2071C			TLE2071AC			UNIT	
			MIN	TYP	MAX	MIN	TYP	MAX		
SR+ Positive slew rate	$V_{O(PP)} = \pm 2.3$ V, $A_{VD} = -1$, $C_L = 100$ pF, $R_L = 2$ k Ω , See Figure 1	25°C	35			35			V/ μ s	
		Full range	23			23				
SR– Negative slew rate		25°C	38			38			V/ μ s	
		Full range	23			23				
t_s Settling time	$A_{VD} = -1$, 2-V step, $R_L = 1$ k Ω , $C_L = 100$ pF	To 10 mV	0.25			0.25			μ s	
		To 1 mV	0.4			0.4				
V_n Equivalent input noise voltage	$R_S = 20$ Ω , See Figure 3	f = 10 Hz	28	55		28	55	nV/ \sqrt{Hz}		
		f = 10 kHz	11.6	17		11.6	17			
$V_{N(PP)}$ Peak-to-peak equivalent input noise voltage		f = 10 Hz to 10 kHz	6			6			μ V	
		f = 0.1 Hz to 10 Hz	0.6			0.6				
I_n Equivalent input noise current	$V_{IC} = 0$, f = 10 kHz	25°C	2.8			2.8			fA/ \sqrt{Hz}	
THD + N Total harmonic distortion plus noise	$V_{O(PP)} = 5$ V, f = 1 kHz, $R_S = 25$ Ω	$A_{VD} = 10$, $R_L = 2$ k Ω ,	25°C	0.013%			0.013%			
B_1 Unity-gain bandwidth	$V_I = 10$ mV, $C_L = 25$ pF,	$R_L = 2$ k Ω , See Figure 2	25°C	9.4			9.4			MHz
B_{OM} Maximum output-swing bandwidth	$V_{O(PP)} = 4$ V, $R_L = 2$ k Ω ,	$A_{VD} = -1$, $C_L = 25$ pF	25°C	2.8			2.8			MHz
ϕ_m Phase margin at unity gain	$V_I = 10$ mV, $C_L = 25$ pF,	$R_L = 2$ k Ω , See Figure 2	25°C	56°			56°			

† Full range is 0°C to 70°C.

TLE2071, TLE2071A, TLE2071Y EXCALIBUR LOW-NOISE HIGH-SPEED JFET-INPUT OPERATIONAL AMPLIFIERS

SLOS119A – JUNE 1993 – REVISED AUGUST 1994

electrical characteristics at specified free-air temperature, $V_{CC\pm} = \pm 15$ V (unless otherwise noted)

PARAMETER	TEST CONDITIONS	T_A †	TLE2071C			TLE2071AC			UNIT	
			MIN	TYP	MAX	MIN	TYP	MAX		
V_{IO} Input offset voltage	$V_{IC} = 0, V_O = 0,$ $R_S = 50 \Omega$	25°C	0.49	4		0.47	2	mV		
		Full range			6		4			
α_{VIO} Temperature coefficient of input offset voltage		Full range	3.2	29		3.2	29	$\mu\text{V}/^\circ\text{C}$		
I_{IO} Input offset current	$V_{IC} = 0, V_O = 0,$ See Figure 4	25°C	6	100		6	100	pA		
		Full range		1.4		1.4		nA		
I_{IB} Input bias current		25°C	20	175		20	175	pA		
		Full range		5		5		nA		
V_{ICR} Common-mode input voltage range	$R_S = 50 \Omega$	25°C	15 to -11	15 to -11.9		15 to -11	15 to -11.9	V		
		Full range	15 to -10.9			15 to -10.9				
V_{OM+} Maximum positive peak output voltage swing	$I_O = -200 \mu\text{A}$	25°C	13.8	14.1		13.8	14.1	V		
		Full range	13.7			13.7				
	$I_O = -2 \text{ mA}$	25°C	13.5	13.9		13.5	13.9			
		Full range	13.4			13.4				
	$I_O = -20 \text{ mA}$	25°C	11.5	12.3		11.5	12.3			
		Full range	11.5			11.5				
V_{OM-} Maximum negative peak output voltage swing	$I_O = 200 \mu\text{A}$	25°C	-13.8	-14.2		-13.8	-14.2	V		
		Full range	-13.7			-13.7				
	$I_O = 2 \text{ mA}$	25°C	-13.5	-14		-13.5	-14			
		Full range	-13.4			-13.4				
	$I_O = 20 \text{ mA}$	25°C	-11.5	-12.4		-11.5	-12.4			
		Full range	-11.5			-11.5				
A_{VD} Large-signal differential voltage amplification	$V_O = \pm 10 \text{ V}$	$R_L = 600 \Omega$	25°C	80	96		80	96	dB	
			Full range	79			79			
		$R_L = 2 \text{ k}\Omega$	25°C	90	109		90	109		
			Full range	89			89			
		$R_L = 10 \text{ k}\Omega$	25°C	95	118		95	118		
			Full range	94			94			
r_i Input resistance	$V_{IC} = 0$	25°C	10^{12}			10^{12}			Ω	
c_i Input capacitance	$V_{IC} = 0,$ See Figure 5	Common mode	25°C	7.5			7.5			pF
		Differential	25°C	2.5			2.5			
z_o Open-loop output impedance	$f = 1 \text{ MHz}$	25°C	80			80			Ω	
CMRR Common-mode rejection ratio	$V_{IC} = V_{ICRmin},$ $V_O = 0, R_S = 50 \Omega$	25°C	80	98		80	98	dB		
		Full range	79			79				
k_{SVR} Supply-voltage rejection ratio ($\Delta V_{CC\pm}/\Delta V_{IO}$)	$V_{CC\pm} = \pm 5 \text{ V to } \pm 15 \text{ V},$ $V_O = 0, R_S = 50 \Omega$	25°C	82	99		82	99	dB		
		Full range	80			81				

† Full range is 0°C to 70°C.



TLE2071, TLE2071A, TLE2071Y
EXCALIBUR LOW-NOISE HIGH-SPEED
JFET-INPUT OPERATIONAL AMPLIFIERS

SLOS119A – JUNE 1993 – REVISED AUGUST 1994

electrical characteristics at specified free-air temperature, $V_{CC\pm} = \pm 15$ V (unless otherwise noted)
(continued)

PARAMETER	TEST CONDITIONS	T_A †	TLE2071C			TLE2071AC			UNIT	
			MIN	TYP	MAX	MIN	TYP	MAX		
I_{CC}	Supply current	$V_O = 0$, No load	25°C	1.35	1.7	2.2	1.35	1.7	2.2	mA
			Full range	2.2			2.2			
I_{OS}	Short-circuit output current	$V_O = 0$	$V_{ID} = 1$ V	-30	-45		-30	-45		mA
			$V_{ID} = -1$ V	30	48		30	48		

operating characteristics at specified free-air temperature, $V_{CC\pm} = \pm 15$ V

PARAMETER	TEST CONDITIONS	T_A †	TLE2071C			TLE2071AC			UNIT	
			MIN	TYP	MAX	MIN	TYP	MAX		
SR+	Positive slew rate	$V_{O(PP)} = 10$ V, $A_{VD} = -1$, $R_L = 2$ k Ω , $C_L = 100$ pF, See Figure 1	25°C	30	40		30	40	V/ μ s	
			Full range	27			27			
SR-	Negative slew rate	See Figure 1	25°C	30	45		30	45	V/ μ s	
			Full range	27			27			
t_s	Settling time	$A_{VD} = -1$, 10-V step, $R_L = 1$ k Ω , $C_L = 100$ pF	To 10 mV	0.4			0.4			μ s
			To 1 mV	1.5			1.5			
V_n	Equivalent input noise voltage	$R_S = 20$ Ω , See Figure 3	f = 10 Hz	28	55		28	55	nV/ \sqrt{Hz}	
			f = 10 kHz	11.6	17		11.6	17		
$V_{N(PP)}$	Peak-to-peak equivalent input noise voltage	See Figure 3	f = 10 Hz to 10 kHz	6			6			μ V
			f = 0.1 Hz to 10 Hz	0.6			0.6			
I_n	Equivalent input noise current	$V_{IC} = 0$, f = 10 kHz	25°C	2.8			2.8			fA/ \sqrt{Hz}
THD + N	Total harmonic distortion plus noise	$V_{O(PP)} = 20$ V, $A_{VD} = 10$, f = 1 kHz, $R_S = 25$ Ω	25°C	0.008%			0.008%			
B_1	Unity-gain bandwidth	$V_I = 10$ mV, $R_L = 2$ k Ω , $C_L = 25$ pF, See Figure 2	25°C	8	10		8	10	MHz	
B_{OM}	Maximum output-swing bandwidth	$V_{O(PP)} = 20$ V, $A_{VD} = -1$, $R_L = 2$ k Ω , $C_L = 25$ pF	25°C	478	637		478	637	kHz	
ϕ_m	Phase margin at unity gain	$V_I = 10$ mV, $R_L = 2$ k Ω , See Figure 2	25°C	57°			57°			

† Full range is 0°C to 70°C.



TLE2071, TLE2071A, TLE2071Y
EXCALIBUR LOW-NOISE HIGH-SPEED
JFET-INPUT OPERATIONAL AMPLIFIERS

SLOS119A – JUNE 1993 – REVISED AUGUST 1994

electrical characteristics at specified free-air temperature, $V_{CC\pm} = \pm 5$ V (unless otherwise noted)

PARAMETER	TEST CONDITIONS	T_A †	TLE2071I			TLE2071AI			UNIT	
			MIN	TYP	MAX	MIN	TYP	MAX		
V_{IO} Input offset voltage	$V_{IC} = 0,$ $R_S = 50 \Omega,$ $V_O = 0,$	25°C	0.34	4		0.3	2	mV		
		Full range			7.6		5.6			
αV_{IO} Temperature coefficient of input offset voltage		Full range	3.2	29		3.2	29	$\mu V/^\circ C$		
I_{IO} Input offset current	$V_{IC} = 0,$ $V_O = 0,$ See Figure 4	25°C	5	100		5	100	pA		
		Full range		5		5		nA		
I_{IB} Input bias current		25°C	15	175		15	175	pA		
		Full range		10		10		nA		
V_{ICR} Common-mode input voltage range	$R_S = 50 \Omega$	25°C	5 to -1	5 to -1.9		5 to -1	5 to -1.9	V		
		Full range	5 to -0.8		5 to -0.8					
V_{OM+} Maximum positive peak output voltage swing	$I_O = -200 \mu A$	25°C	3.8	4.1		3.8	4.1	V		
		Full range	3.7		3.7					
	$I_O = -2$ mA	25°C	3.5	3.9		3.5	3.9			
		Full range	3.4		3.4					
	$I_O = -20$ mA	25°C	1.5	2.3		1.5	2.3			
		Full range	1.5		1.5					
V_{OM-} Maximum negative peak output voltage swing	$I_O = 200 \mu A$	25°C	-3.8	-4.2		-3.8	-4.2	V		
		Full range	-3.7		-3.7					
	$I_O = 2$ mA	25°C	-3.5	-4.1		-3.5	-4.1			
		Full range	-3.4		-3.4					
	$I_O = 20$ mA	25°C	-1.5	-2.4		-1.5	-2.4			
		Full range	-1.5		-1.5					
A_{VD} Large-signal differential voltage amplification	$V_O = \pm 2.3$ V	$R_L = 600 \Omega$	25°C	80	91		80	91	dB	
			Full range	79		79				
		$R_L = 2$ k Ω	25°C	90	100		90	100		
			Full range	89		89				
		$R_L = 10$ k Ω	25°C	95	106		95	106		
			Full range	94		94				
r_i Input resistance	$V_{IC} = 0$	25°C	10^{12}			10^{12}			Ω	
c_i Input capacitance	$V_{IC} = 0,$ See Figure 5	Common mode	25°C	11			11			pF
		Differential	25°C	2.5			2.5			
z_o Open-loop output impedance	$f = 1$ MHz	25°C	80			80			Ω	
CMRR Common-mode rejection ratio	$V_{IC} = V_{ICRmin},$ $V_O = 0,$ $R_S = 50 \Omega$	25°C	70	89		70	89	dB		
		Full range	68		68					
k_{SVR} Supply-voltage rejection ratio ($\Delta V_{CC\pm}/\Delta V_{IO}$)	$V_{CC\pm} = \pm 5$ V to ± 15 V, $V_O = 0,$ $R_S = 50 \Omega$	25°C	82	99		82	99	dB		
		Full range	80		80					

† Full range is $-40^\circ C$ to $85^\circ C$.



TLE2071, TLE2071A, TLE2071Y
EXCALIBUR LOW-NOISE HIGH-SPEED
JFET-INPUT OPERATIONAL AMPLIFIERS

SLOS119A – JUNE 1993 – REVISED AUGUST 1994

electrical characteristics at specified free-air temperature, $V_{CC\pm} = \pm 5$ V (unless otherwise noted)
(continued)

PARAMETER	TEST CONDITIONS	T_A †	TLE2071I			TLE2071AI			UNIT
			MIN	TYP	MAX	MIN	TYP	MAX	
I_{CC} Supply current	$V_O = 0$, No load	25°C	1.35	1.6	2.2	1.35	1.6	2.2	mA
		Full range	2.2			2.2			
I_{OS} Short-circuit output current	$V_O = 0$	25°C	$V_{ID} = 1$ V			–35			mA
			$V_{ID} = -1$ V			45			

operating characteristics at specified free-air temperature, $V_{CC\pm} = \pm 5$ V

PARAMETER	TEST CONDITIONS	T_A †	TLE2071I			TLE2071AI			UNIT	
			MIN	TYP	MAX	MIN	TYP	MAX		
SR+ Positive slew rate	$V_{O(PP)} = \pm 2.3$ V, $A_{VD} = -1$, $R_L = 2$ k Ω , $C_L = 100$ pF, See Figure 1	25°C	35			35			V/ μ s	
		Full range	22			22				
SR– Negative slew rate		25°C	38			38			V/ μ s	
		Full range	22			22				
t_s Settling time	$A_{VD} = -1$, 2-V step, $R_L = 1$ k Ω , $C_L = 100$ pF	25°C	To 10 mV			0.25			μ s	
			To 1 mV			0.4				
V_n Equivalent input noise voltage	$R_S = 20$ Ω , See Figure 3	25°C	f = 10 Hz			28 55			nV/ \sqrt{Hz}	
			f = 10 kHz			11.6 17				
$V_{N(PP)}$ Peak-to-peak equivalent input noise voltage		f = 10 Hz to 10 kHz	25°C	6			6			μ V
				f = 0.1 Hz to 10 Hz			0.6			
I_n Equivalent input noise current	$V_{IC} = 0$, f = 10 kHz	25°C	2.8			2.8			fA/ \sqrt{Hz}	
THD + N Total harmonic distortion plus noise	$V_{O(PP)} = 5$ V, $A_{VD} = 10$, f = 1 kHz, $R_L = 2$ k Ω , $R_S = 25$ Ω	25°C	0.013%			0.013%				
B_1 Unity-gain bandwidth	$V_I = 10$ mV, $R_L = 2$ k Ω , $C_L = 25$ pF, See Figure 2	25°C	9.4			9.4			MHz	
B_{OM} Maximum output-swing bandwidth	$V_{O(PP)} = 4$ V, $A_{VD} = -1$, $R_L = 2$ k Ω , $C_L = 25$ pF	25°C	2.8			2.8			MHz	
ϕ_m Phase margin at unity gain	$V_I = 10$ mV, $R_L = 2$ k Ω , $C_L = 25$ pF, See Figure 2	25°C	56°			56°				

† Full range is 40°C to 85°C.

TLE2071, TLE2071A, TLE2071Y
EXCALIBUR LOW-NOISE HIGH-SPEED
JFET-INPUT OPERATIONAL AMPLIFIERS

SLOS119A – JUNE 1993 – REVISED AUGUST 1994

electrical characteristics at specified free-air temperature, $V_{CC\pm} = \pm 15$ V (unless otherwise noted)

PARAMETER	TEST CONDITIONS	T_A †	TLE2071I			TLE2071AI			UNIT		
			MIN	TYP	MAX	MIN	TYP	MAX			
V_{IO} Input offset voltage	$V_{IC} = 0,$ $R_S = 50 \Omega,$ $V_O = 0,$	25°C	0.49	4		0.47	2	mV			
		Full range			7.6		5.6				
αV_{IO} Temperature coefficient of input offset voltage		Full range	3.2	29		3.2	29	$\mu V/^\circ C$			
I_{IO} Input offset current	$V_{IC} = 0,$ $V_O = 0,$ See Figure 4	25°C	6	100		6	100	pA			
		Full range		5		5		nA			
I_{IB} Input bias current		25°C	20	175		20	175	pA			
		Full range		10		10		nA			
V_{ICR} Common-mode input voltage range	$R_S = 50 \Omega$	25°C	15 to -11	15 to -11.9		15 to -11	15 to -11.9	V			
		Full range	15 to -10.8			15 to -10.8					
V_{OM+} Maximum positive peak output voltage swing	$I_O = -200 \mu A$	25°C	13.8	14.1		13.8	14.1	V			
		Full range	13.7			13.7					
	$I_O = -2$ mA	25°C	13.5	13.9		13.5	13.9				
		Full range	13.4			13.4					
	$I_O = -20$ mA	25°C	11.5	12.3		11.5	12.3				
		Full range	11.5			11.5					
V_{OM-} Maximum negative peak output voltage swing	$I_O = 200 \mu A$	25°C	-13.8	-14.2		-13.8	-14.2	V			
		Full range	-13.7			-13.7					
	$I_O = 2$ mA	25°C	-13.5	-14		-13.5	-14				
		Full range	-13.4			-13.4					
	$I_O = 20$ mA	25°C	-11.5	-12.4		-11.5	-12.4				
		Full range	-11.5			-11.5					
A_{VD} Large-signal differential voltage amplification	$V_O = \pm 10$ V	$R_L = 600 \Omega$	25°C	80	96		80	96	dB		
			Full range	79			79				
		$R_L = 2$ k Ω	25°C	90	109		90	109			
			Full range	89			89				
		$R_L = 10$ k Ω	25°C	95	118		95	118			
			Full range	94			94				
r_i Input resistance	$V_{IC} = 0$	25°C	10^{12}			10^{12}			Ω		
c_i Input capacitance	$V_{IC} = 0,$ See Figure 5	Common mode	25°C	7.5			7.5			pF	
		Differential	25°C	2.5			2.5				
z_o Open-loop output impedance	$f = 1$ MHz	25°C	80			80			Ω		
CMRR Common-mode rejection ratio	$V_{IC} = V_{ICRmin},$ $V_O = 0,$ $R_S = 50 \Omega$	25°C	80	98			80	98			dB
		Full range	79				79				
k_{SVR} Supply-voltage rejection ratio ($\Delta V_{CC\pm}/\Delta V_{IO}$)	$V_{CC\pm} = \pm 5$ V to ± 15 V, $V_O = 0,$ $R_S = 50 \Omega$	25°C	82	99			82	99			dB
		Full range	80				80				

† Full range is $-40^\circ C$ to $85^\circ C$.



TLE2071, TLE2071A, TLE2071Y
EXCALIBUR LOW-NOISE HIGH-SPEED
JFET-INPUT OPERATIONAL AMPLIFIERS

SLOS119A – JUNE 1993 – REVISED AUGUST 1994

electrical characteristics at specified free-air temperature, $V_{CC\pm} = \pm 15$ V (unless otherwise noted)
(continued)

PARAMETER	TEST CONDITIONS	T_A †	TLE2071I			TLE2071AI			UNIT
			MIN	TYP	MAX	MIN	TYP	MAX	
I_{CC} Supply current	$V_O = 0$, No load	25°C	1.35	1.7	2.2	1.35	1.7	2.2	mA
		Full range	2.2			2.2			
I_{OS} Short-circuit output current	$V_O = 0$	$V_{ID} = 1$ V	-30	-45		-30	-45		mA
		$V_{ID} = -1$ V	30	48		30	48		

operating characteristics at specified free-air temperature, $V_{CC\pm} = \pm 15$ V

PARAMETER	TEST CONDITIONS	T_A †	TLE2071I			TLE2071AI			UNIT
			MIN	TYP	MAX	MIN	TYP	MAX	
SR+ Positive slew rate	$V_{O(PP)} = \pm 10$ V, $A_{VD} = -1$, $C_L = 100$ pF, $R_L = 2$ k Ω , See Figure 1	25°C	30	40		30	40		V/ μ s
		Full range	24			24			
SR- Negative slew rate		25°C	30	45		30	45		V/ μ s
		Full range	24			24			
t_s Settling time	$A_{VD} = -1$, 10-V step, $R_L = 1$ k Ω , $C_L = 100$ pF	To 10 mV	0.4			0.4			μ s
		To 1 mV	1.5			1.5			
V_n Equivalent input noise voltage	$R_S = 20$ Ω , See Figure 3	f = 10 Hz	28 55			28 55			nV/ \sqrt{Hz}
		f = 10 kHz	11.6 17			11.6 17			
$V_{N(PP)}$ Peak-to-peak equivalent input noise voltage		f = 10 Hz to 10 kHz	6			6			μ V
		f = 0.1 Hz to 10 Hz	0.6			0.6			
I_n Equivalent input noise current	$V_{IC} = 0$, f = 10 kHz	25°C	2.8			2.8			fA/ \sqrt{Hz}
THD + N Total harmonic distortion plus noise	$V_{O(PP)} = 20$ V, $A_{VD} = 10$, f = 1 kHz, $R_L = 2$ k Ω , $R_S = 25$ Ω	25°C	0.008%			0.008%			
B_1 Unity-gain bandwidth	$V_I = 10$ mV, $R_L = 2$ k Ω , $C_L = 25$ pF, See Figure 2	25°C	8	10		8	10		MHz
B_{OM} Maximum output-swing bandwidth	$V_{O(PP)} = 20$ V, $A_{VD} = -1$, $R_L = 2$ k Ω , $C_L = 25$ pF	25°C	478	637		478	637		kHz
ϕ_m Phase margin at unity gain	$V_I = 10$ mV, $R_L = 2$ k Ω , $C_L = 25$ pF, See Figure 2	25°C	57°			57°			

† Full range is -40°C to 85°C .



TLE2071, TLE2071A, TLE2071Y
EXCALIBUR LOW-NOISE HIGH-SPEED
JFET-INPUT OPERATIONAL AMPLIFIERS

SLOS119A – JUNE 1993 – REVISED AUGUST 1994

electrical characteristics at specified free-air temperature, $V_{CC\pm} = \pm 5$ V (unless otherwise noted)

PARAMETER	TEST CONDITIONS	T_A †	TLE2071M			TLE2071AM			UNIT	
			MIN	TYP	MAX	MIN	TYP	MAX		
V_{IO} Input offset voltage	$V_{IC} = 0,$ $R_S = 50 \Omega,$ $V_O = 0,$	25°C	0.34	4		0.3	2	mV		
		Full range			9.2		7.2			
α_{VIO} Temperature coefficient of input offset voltage		Full range	3.2	29*		3.2	29*	$\mu\text{V}/^\circ\text{C}$		
I_{IO} Input offset current	$V_{IC} = 0,$ $V_O = 0,$ See Figure 4	25°C	5	100		5	100	pA		
		Full range			20		20	nA		
I_{IB} Input bias current		25°C	15	175		15	175	pA		
		Full range			65		65	nA		
V_{ICR} Common-mode input voltage range	$R_S = 50 \Omega$	25°C	5 to -1	5 to -1.9		5 to -1	5 to -1.9	V		
		Full range	5 to -0.8			5 to -0.8				
V_{OM+} Maximum positive peak output voltage swing	$I_O = -200 \mu\text{A}$	25°C	3.8	4.1		3.8	4.1	V		
		Full range	3.6			3.6				
		25°C	3.5	3.9		3.5	3.9			
		Full range	3.3			3.3				
V_{OM-} Maximum negative peak output voltage swing	$I_O = -20 \text{ mA}$	25°C	1.5	2.3		1.5	2.3	V		
		Full range	1.4			1.4				
		25°C	-3.8	-4.2		-3.8	-4.2			
		Full range	-3.6			-3.6				
V_{OM-} Maximum negative peak output voltage swing	$I_O = 200 \mu\text{A}$	25°C	-3.5	-4.1		-3.5	-4.1	V		
		Full range	-3.3			-3.3				
		25°C	-1.5	-2.4		-1.5	-2.4			
		Full range	-1.4			-1.4				
A_{VD} Large-signal differential voltage amplification	$V_O = \pm 2.3 \text{ V}$	$R_L = 600 \Omega$	25°C	80	91		80	91	dB	
			Full range	78			78			
		$R_L = 2 \text{ k}\Omega$	25°C	90	100		90	100		
			Full range	88			88			
		$R_L = 10 \text{ k}\Omega$	25°C	95	106		95	106		
			Full range	93			93			
r_i Input resistance	$V_{IC} = 0$	25°C	10^{12}			10^{12}			Ω	
c_i Input capacitance	$V_{IC} = 0,$ See Figure 5	Common mode	25°C	11			11			pF
		Differential	25°C	2.5			2.5			
z_o Open-loop output impedance	$f = 1 \text{ MHz}$	25°C	80			80			Ω	
CMRR Common-mode rejection ratio	$V_{IC} = V_{ICRmin},$ $V_O = 0,$ $R_S = 50 \Omega$	25°C	70	89		70	89	dB		
		Full range	68			68				
k_{SVR} Supply-voltage rejection ratio ($\Delta V_{CC\pm} / \Delta V_{IO}$)	$V_{CC\pm} = \pm 5 \text{ V to } \pm 15 \text{ V},$ $V_O = 0,$ $R_S = 50 \Omega$	25°C	82	99		82	99	dB		
		Full range	80			80				

*On products compliant to MIL-STD-883, Class B, this parameter is not production tested.

† Full range is -55°C to 125°C .



TLE2071, TLE2071A, TLE2071Y
EXCALIBUR LOW-NOISE HIGH-SPEED
JFET-INPUT OPERATIONAL AMPLIFIERS

SLOS119A – JUNE 1993 – REVISED AUGUST 1994

electrical characteristics at specified free-air temperature, $V_{CC\pm} = \pm 5\text{ V}$ (unless otherwise noted)

PARAMETER	TEST CONDITIONS	T_A †	TLE2071M			TLE2071AM			UNIT
			MIN	TYP	MAX	MIN	TYP	MAX	
I_{CC} Supply current	$V_O = 0$, No load	25°C	1.35	1.6	2.2	1.35	1.6	2.2	mA
		Full range	2.2			2.2			
I_{OS} Short-circuit output current	$V_O = 0$	$V_{ID} = 1\text{ V}$	-35			-35			mA
		$V_{ID} = -1\text{ V}$	45			45			

operating characteristics at specified free-air temperature, $V_{CC\pm} = \pm 5\text{ V}$

PARAMETER	TEST CONDITIONS	T_A †	TLE2071M			TLE2071AM			UNIT	
			MIN	TYP	MAX	MIN	TYP	MAX		
$SR+$ Positive slew rate	$V_{O(PP)} = \pm 2.3\text{ V}$, $A_{VD} = -1$, $C_L = 100\text{ pF}$, $R_L = 2\text{ k}\Omega$, See Figure 1	25°C	35			35			$\text{V}/\mu\text{s}$	
		Full range	20*			20*				
$SR-$ Negative slew rate	$V_{O(PP)} = \pm 2.3\text{ V}$, $A_{VD} = -1$, $C_L = 100\text{ pF}$, $R_L = 2\text{ k}\Omega$, See Figure 1	25°C	38			38			$\text{V}/\mu\text{s}$	
		Full range	20*			20*				
t_s Settling time	$A_{VD} = -1$, 2-V step, $R_L = 1\text{ k}\Omega$, $C_L = 100\text{ pF}$	To 10 mV	0.25			0.25			μs	
		To 1 mV	0.4			0.4				
V_n Equivalent input noise voltage	$R_S = 20\ \Omega$, See Figure 3	f = 10 Hz	28	55*		28	55*	$\text{nV}/\sqrt{\text{Hz}}$		
		f = 10 kHz	11.6	17*		11.6	17*			
$V_{N(PP)}$ Peak-to-peak equivalent input noise voltage	$R_S = 20\ \Omega$, See Figure 3	f = 10 Hz to 10 kHz	6			6			μV	
		f = 0.1 Hz to 10 Hz	0.6			0.6				
I_n Equivalent input noise current	$V_{IC} = 0$, f = 10 kHz	25°C	2.8			2.8			$\text{fA}/\sqrt{\text{Hz}}$	
THD + N Total harmonic distortion plus noise	$V_{O(PP)} = 5\text{ V}$, f = 1 kHz, $R_S = 25\ \Omega$	$A_{VD} = 10$, $R_L = 2\text{ k}\Omega$,	25°C	0.013%			0.013%			
B_1 Unity-gain bandwidth	$V_I = 10\text{ mV}$, $C_L = 25\text{ pF}$,	$R_L = 2\text{ k}\Omega$, See Figure 2	25°C	9.4			9.4			MHz
B_{OM} Maximum output-swing bandwidth	$V_{O(PP)} = 4\text{ V}$, $R_L = 2\text{ k}\Omega$,	$A_{VD} = -1$, $C_L = 25\text{ pF}$	25°C	2.8			2.8			MHz
ϕ_m Phase margin at unity gain	$V_I = 10\text{ mV}$, $C_L = 25\text{ pF}$,	$R_L = 2\text{ k}\Omega$, See Figure 2	25°C	56°			56°			

*On products compliant to MIL-STD-883, Class B, this parameter is not production tested.

† Full range is -55°C to 125°C .



TLE2071, TLE2071A, TLE2071Y
EXCALIBUR LOW-NOISE HIGH-SPEED
JFET-INPUT OPERATIONAL AMPLIFIERS

SLOS119A – JUNE 1993 – REVISED AUGUST 1994

electrical characteristics at specified free-air temperature, $V_{CC\pm} = \pm 15$ V (unless otherwise noted)

PARAMETER	TEST CONDITIONS	T _A †	TLE2071M			TLE2071AM			UNIT
			MIN	TYP	MAX	MIN	TYP	MAX	
V _{IO} Input offset voltage	V _{IC} = 0, V _O = 0, R _S = 50 Ω	25°C	0.49	4		0.47	2	mV	
		Full range			9.2		7.2		
αV _{IO} Temperature coefficient of input offset voltage		Full range	3.2	29*		3.2	29*	μV/°C	
I _{IO} Input offset current	V _{IC} = 0, V _O = 0, See Figure 4	25°C	6	100		6	100	pA	
		Full range			20		20	nA	
I _{IB} Input bias current		25°C	20	175		20	175	pA	
		Full range			65		65	nA	
V _{ICR} Common-mode input voltage range	R _S = 50 Ω	25°C	15 to -11	15 to -11.9		15 to -11	15 to -11.9	V	
		Full range	15 to -10.9			15 to -10.9			
V _{OM+} Maximum positive peak output voltage swing	I _O = -200 μA	25°C	13.8	14.1		13.8	14.1	V	
		Full range	13.6			13.6			
	I _O = -2 mA	25°C	13.5	13.9		13.5	13.9		
		Full range	13.3			13.3			
	I _O = -20 mA	25°C	11.5	12.3		11.5	12.3		
		Full range	11.4			11.4			
V _{OM-} Maximum negative peak output voltage swing	I _O = 200 μA	25°C	-13.8	-14.2		-13.8	-14.2	V	
		Full range	-13.6			-13.6			
	I _O = 2 mA	25°C	-13.5	-14		-13.5	-14		
		Full range	-13.3			-13.3			
	I _O = 20 mA	25°C	-11.5	-12.4		-11.5	-12.4		
		Full range	-11.4			-11.4			
A _{VD} Large-signal differential voltage amplification	V _O = ± 10 V	R _L = 600 Ω	25°C	80	96		80	96	dB
			Full range	78			78		
		R _L = 2 kΩ	25°C	90	109		90	109	
			Full range	88			88		
		R _L = 10 kΩ	25°C	95	118		95	118	
			Full range	93			93		
r _i Input resistance	V _{IC} = 0	25°C	10 ¹²		10 ¹²		Ω		
c _i Input capacitance	V _{IC} = 0, See Figure 5	Common mode	25°C	7.5		7.5		pF	
		Differential	25°C	2.5		2.5			
z _o Open-loop output impedance	f = 1 MHz	25°C	80		80		Ω		
CMRR Common-mode rejection ratio	V _{IC} = V _{ICRmin} , V _O = 0, R _S = 50 Ω	25°C	80	98		80	98	dB	
		Full range	78			78			
k _{SVR} Supply-voltage rejection ratio (ΔV _{CC±} /ΔV _{IO})	V _{CC±} = ±5 V to ±15 V, V _O = 0, R _S = 50 Ω	25°C	82	99		82	99	dB	
		Full range	80			80			

*On products compliant to MIL-STD-883, Class B, this parameter is not production tested.

† Full range is -55°C to 125°C.



TLE2071, TLE2071A, TLE2071Y
EXCALIBUR LOW-NOISE HIGH-SPEED
JFET-INPUT OPERATIONAL AMPLIFIERS

SLOS119A – JUNE 1993 – REVISED AUGUST 1994

electrical characteristics at specified free-air temperature, $V_{CC\pm} = \pm 15$ V (unless otherwise noted)
(continued)

PARAMETER	TEST CONDITIONS	T_A †	TLE2071M			TLE2071AM			UNIT
			MIN	TYP	MAX	MIN	TYP	MAX	
I_{CC} Supply current	$V_O = 0$, No load	25°C	1.35	1.7	2.2	1.35	1.7	2.2	mA
		Full range				2.2			
I_{OS} Short-circuit output current	$V_O = 0$	25°C	$V_{ID} = 1$ V	-30	-45	-30	-45	mA	
			$V_{ID} = -1$ V	30	48	30	48		

† Full range is -55°C to 125°C .

operating characteristics at specified free-air temperature, $V_{CC\pm} = \pm 15$ V

PARAMETER	TEST CONDITIONS	T_A †	TLE2071M			TLE2071AM			UNIT
			MIN	TYP	MAX	MIN	TYP	MAX	
$SR+$ Positive slew rate	$V_{O(PP)} = 10$ V, $A_{VD} = -1$, $R_L = 2$ k Ω , $C_L = 100$ pF, See Figure 1	25°C	30	40		30	40	V/ μ s	
		Full range	22			22			
$SR-$ Negative slew rate		25°C	30	45		30	45	V/ μ s	
		Full range	22			22			
t_s Settling time	$A_{VD} = -1$, 10-V step, $R_L = 1$ k Ω , $C_L = 100$ pF	25°C	To 10 mV	0.4		0.4		μ s	
			To 1 mV	1.5		1.5			
V_n Equivalent input noise voltage	$R_S = 20$ Ω , See Figure 3	25°C	f = 10 Hz	28	55*	28	55*	nV/ $\sqrt{\text{Hz}}$	
			f = 10 kHz	11.6	17*	11.6	17*		
$V_{N(PP)}$ Peak-to-peak equivalent input noise voltage		25°C	f = 10 Hz to 10 kHz	6		6		μ V	
			f = 0.1 Hz to 10 Hz	0.6		0.6			
I_n Equivalent input noise current	$V_{IC} = 0$, f = 10 kHz	25°C	2.8		2.8		fA/ $\sqrt{\text{Hz}}$		
THD + N Total harmonic distortion plus noise	$V_{O(PP)} = 20$ V, $A_{VD} = 10$, f = 1 kHz, $R_L = 2$ k Ω , $R_S = 25$ Ω	25°C	0.008%		0.008%				
B_1 Unity-gain bandwidth	$V_I = 10$ mV, $R_L = 2$ k Ω , $C_L = 25$ pF, See Figure 2	25°C	8*	10	8*	10	MHz		
B_{OM} Maximum output-swing bandwidth	$V_{O(PP)} = 20$ V, $A_{VD} = -1$, $R_L = 2$ k Ω , $C_L = 25$ pF	25°C	478*	637	478*	637	kHz		
ϕ_m Phase margin at unity gain	$V_I = 10$ mV, $R_L = 2$ k Ω , $C_L = 25$ pF, See Figure 2	25°C	57°		57°				

*On products compliant to MIL-STD-883, Class B, this parameter is not production tested.

† Full range is -55°C to 125°C .



TLE2071, TLE2071A, TLE2071Y EXCALIBUR LOW-NOISE HIGH-SPEED JFET-INPUT OPERATIONAL AMPLIFIERS

SLOS119A – JUNE 1993 – REVISED AUGUST 1994

electrical characteristics at $V_{CC\pm} = \pm 15\text{ V}$, $T_A = 25^\circ\text{C}$

PARAMETER	TEST CONDITIONS	TLE2071Y			UNIT
		MIN	TYP	MAX	
V_{IO} Input offset voltage	$V_{IC} = 0$, $V_O = 0$, $R_S = 50\ \Omega$		0.49	4	mV
I_{IO} Input offset current	$V_{IC} = 0$, $V_O = 0$, See Figure 4		6	100	pA
I_{IB} Input bias current			20	175	pA
V_{ICR} Common-mode input voltage range	$R_S = 50\ \Omega$	15 to -11	15 to 11.9		V
V_{OM+} Maximum positive peak output voltage swing	$I_O = -200\ \mu\text{A}$	13.8	14.1		V
	$I_O = -2\ \text{mA}$	13.5	13.9		
	$I_O = -20\ \text{mA}$	11.5	12.3		
V_{OM-} Maximum negative peak output voltage swing	$I_O = 200\ \mu\text{A}$	-13.8	-14.2		V
	$I_O = 2\ \text{mA}$	-13.5	-14		
	$I_O = 20\ \text{mA}$	-11.5	-12.4		
A_{VD} Large-signal differential voltage amplification	$V_O = \pm 10\ \text{V}$	$R_L = 600\ \Omega$	80	96	dB
		$R_L = 2\ \text{k}\Omega$	90	109	
		$R_L = 10\ \text{k}\Omega$	95	118	
r_i Input resistance	$V_{IC} = 0$		10^{12}		Ω
c_i Input capacitance	$V_O = 0$, See Figure 5	Common mode	7.5		pF
		Differential	2.5		
z_o Open-loop output impedance	$f = 1\ \text{MHz}$		80		Ω
CMRR Common-mode rejection ratio	$V_{IC} = V_{ICRmin}$, $R_S = 50\ \Omega$, $V_O = 0$	80	98		dB
k_{SVR} Supply-voltage rejection ratio ($\Delta V_{CC\pm}/\Delta V_{IO}$)	$V_{CC\pm} = \pm 5\ \text{V}$ to $\pm 15\ \text{V}$, $R_S = 50\ \Omega$, $V_O = 0$	82	99		dB
I_{CC} Supply current	$V_O = 0$, No load	1.35	1.7	2.2	mA
I_{OS} Short-circuit output current	$V_O = 0$	$V_{ID} = 1\ \text{V}$	-30	-45	mA
		$V_{ID} = -1\ \text{V}$	30	48	

PARAMETER MEASUREMENT INFORMATION

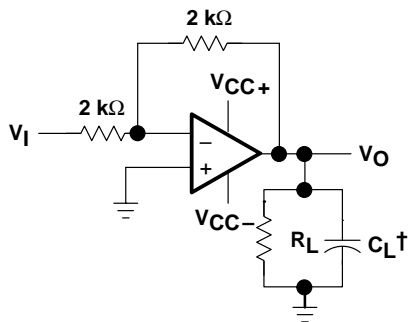

Figure 1. Slew-Rate Test Circuit

† Includes fixture capacitance

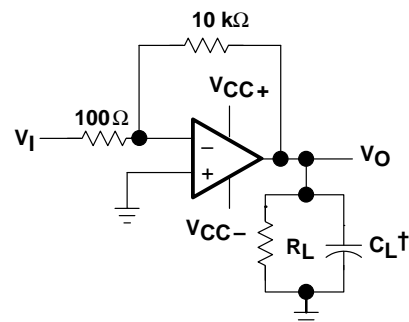

Figure 2. Unity-Gain Bandwidth and Phase-Margin Test Circuit

PARAMETER MEASUREMENT INFORMATION

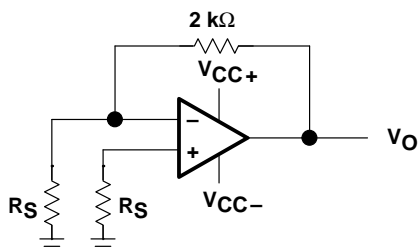

Figure 3. Noise-Voltage Test Circuit

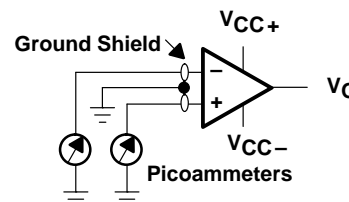

Figure 4. Input-Bias and Offset-Current Test Circuit

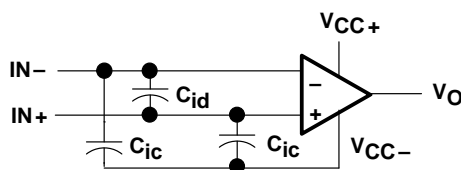

Figure 5. Internal Input Capacitance

typical values

Typical values presented in this data sheet represent the median (50% point) of device parametric performance.

input bias and offset current

At the picoampere bias-current level typical of the TLE2071 and TLE2071A, accurate measurement of the bias becomes difficult. Not only does this measurement require a picoammeter, but test socket leakages can easily exceed the actual device bias currents. To accurately measure these small currents, Texas Instruments uses a two-step process. The socket leakage is measured using picoammeters with bias voltages applied but with no device in the socket. The device is then inserted in the socket and a second test is performed that measures both the socket leakage and the device input bias current. The two measurements are then subtracted algebraically to determine the bias current of the device.

TYPICAL CHARACTERISTICS

Table of Graphs

			FIGURE
V_{IO}	Input offset voltage	Distribution	6
α_{VIO}	Temperature coefficient	Distribution	7
I_{IO}	Input offset current	vs Free-air temperature	8, 9
I_{IB}	Input bias current	vs Free-air temperature vs Supply voltage	8, 9 10
V_{ICR}	Common-mode input voltage range	vs Free-air temperature	11
V_{ID}	Differential input voltage	vs Output voltage	12, 13
V_{OM+}	Maximum positive peak output voltage	vs Output current vs Free-air temperature vs Supply voltage	14 16, 17 18

TLE2071, TLE2071A, TLE2071Y
EXCALIBUR LOW-NOISE HIGH-SPEED
JFET-INPUT OPERATIONAL AMPLIFIERS

SLOS119A – JUNE 1993 – REVISED AUGUST 1994

TYPICAL CHARACTERISTICS

Table of Graphs (Continued)

			FIGURE
V_{OM-}	Maximum negative peak output voltage	vs Output current	15
		vs Free-air temperature	16, 17
		vs Supply voltage	18
$V_{O(PP)}$	Maximum peak-to-peak output voltage	vs Frequency	19
V_O	Output voltage	vs Settling time	20
A_{VD}	Differential voltage amplification	vs Load resistance	21
		vs Free-air temperature	22, 23
		vs Frequency	24, 25
CMRR	Common-mode rejection ratio	vs Frequency	26
		vs Free-air temperature	27
k_{SVR}	Supply-voltage rejection ratio	vs Frequency	28
		vs Free-air temperature	29
I_{CC}	Supply current	vs Supply voltage	30
		vs Free-air temperature	31
		vs Differential input voltage	32, 33
I_{OS}	Short-circuit output current	vs Supply voltage	34
		vs Time	35
		vs Free-air temperature	36
SR	Slew rate	vs Free-air temperature	37, 38
		vs Load resistance	39
		vs Differential input voltage	40
V_n	Equivalent input noise voltage	vs Frequency	41
V_n	Input-referred noise voltage	vs Noise bandwidth	42
		Over a 10-second time interval	43
	Third-octave spectral noise density	vs Frequency bands	44
THD + N	Total harmonic distortion plus noise	vs Frequency	45, 46
B_1	Unity-gain bandwidth	vs Load capacitance	47
	Gain-bandwidth product	vs Free-air temperature	48
		vs Supply voltage	49
	Gain margin	vs Load capacitance	50
ϕ_m	Phase margin	vs Free-air temperature	51
		vs Supply voltage	52
		vs Load capacitance	53
	Phase shift	vs Frequency	24, 25
	Large-signal pulse response, noninverting	vs Time	54
	Small-signal pulse response	vs Time	55
z_o	Closed-loop output impedance	vs Frequency	56

TYPICAL CHARACTERISTICS†

DISTRIBUTION OF TLE2071
 INPUT OFFSET VOLTAGE

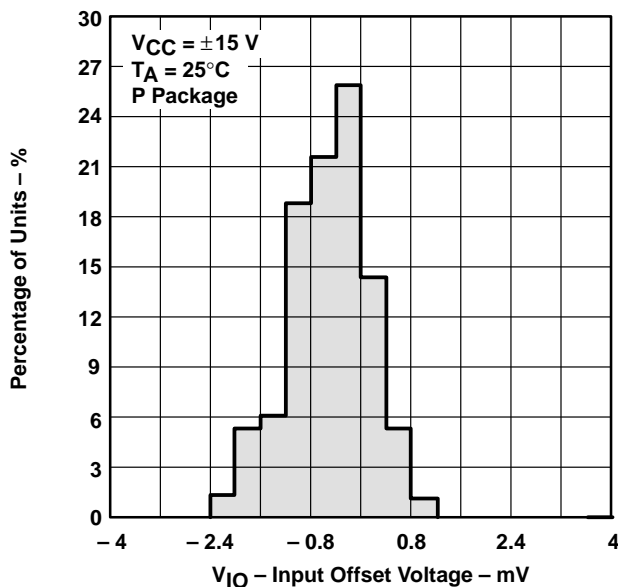

Figure 6

DISTRIBUTION OF TLE2071 INPUT OFFSET
 VOLTAGE TEMPERATURE COEFFICIENT

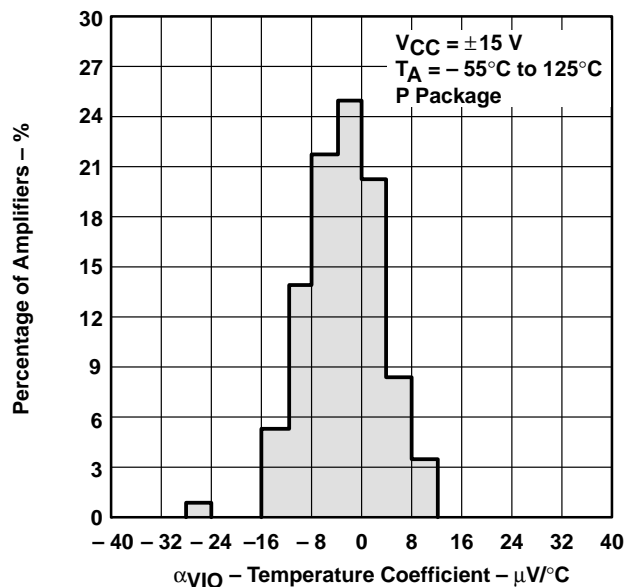

Figure 7

INPUT BIAS CURRENT AND
 INPUT OFFSET CURRENT
 vs
 FREE-AIR TEMPERATURE

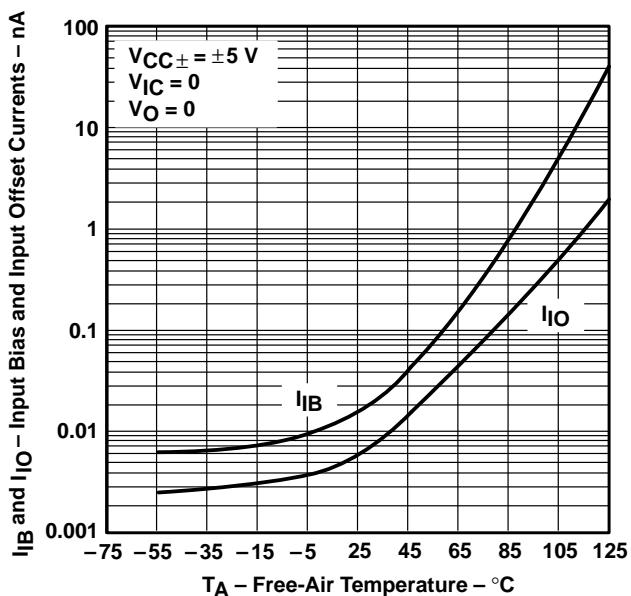

Figure 8

INPUT BIAS CURRENT AND
 INPUT OFFSET CURRENT
 vs
 FREE-AIR TEMPERATURE

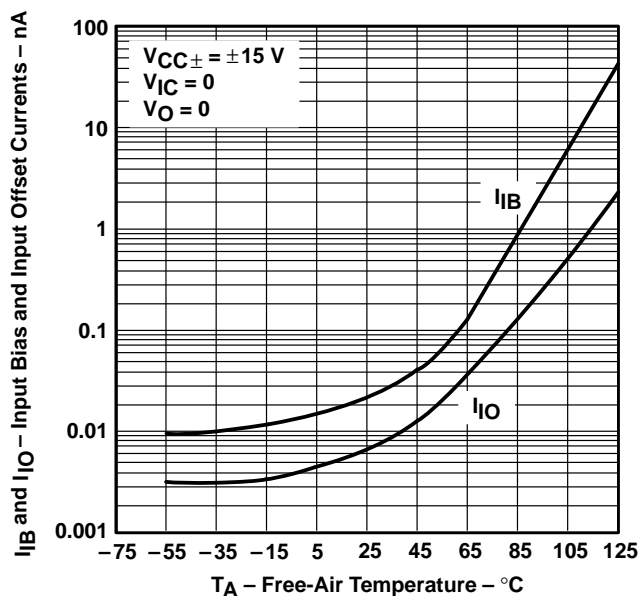
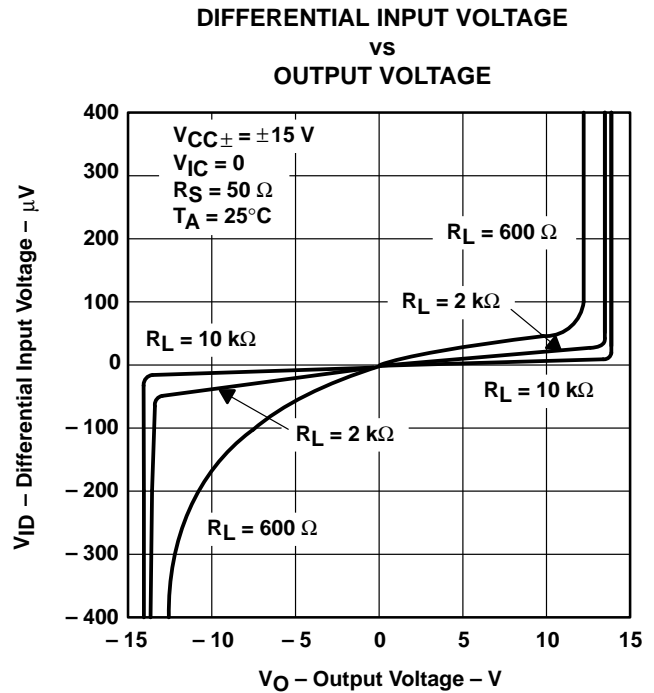
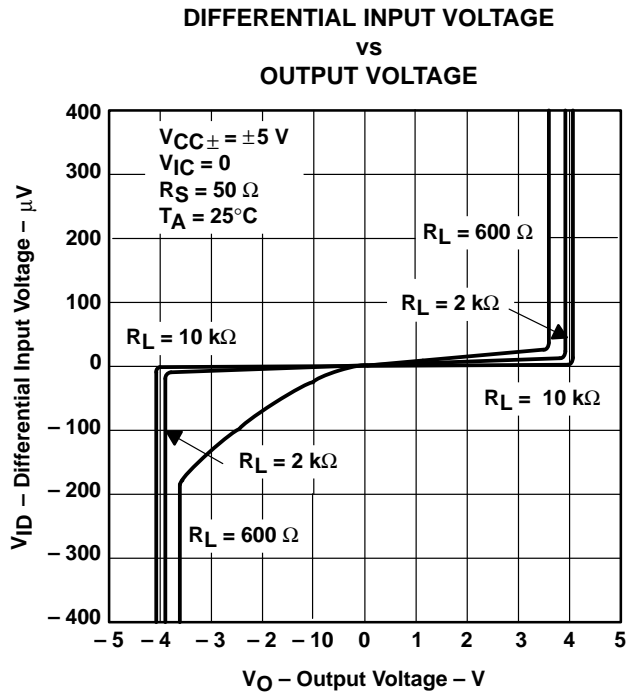
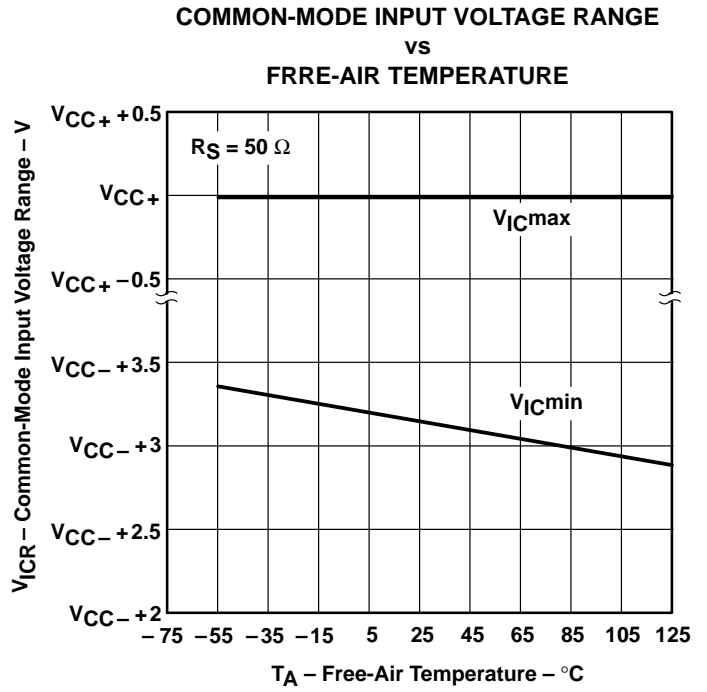
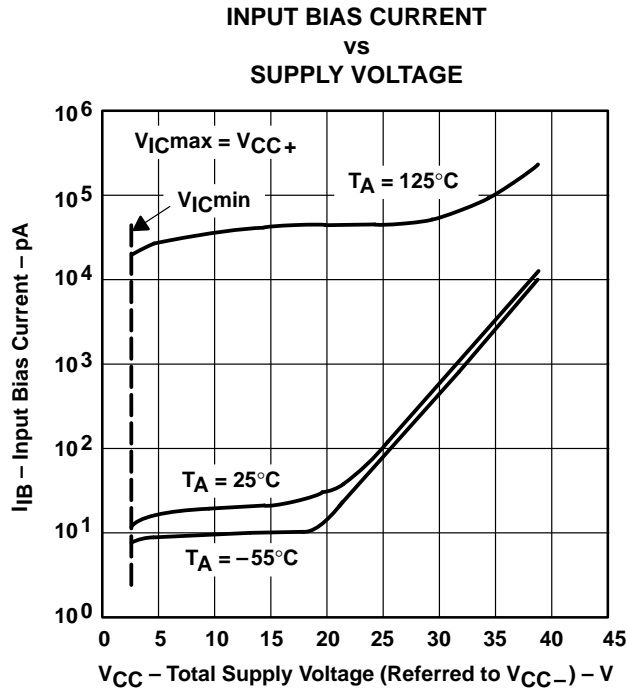

Figure 9

† Data at high and low temperatures are applicable only within the rated operating free-air temperature ranges of the various devices.

TYPICAL CHARACTERISTICS†



† Data at high and low temperatures are applicable only within the rated operating free-air temperature ranges of the various devices.

TYPICAL CHARACTERISTICS†

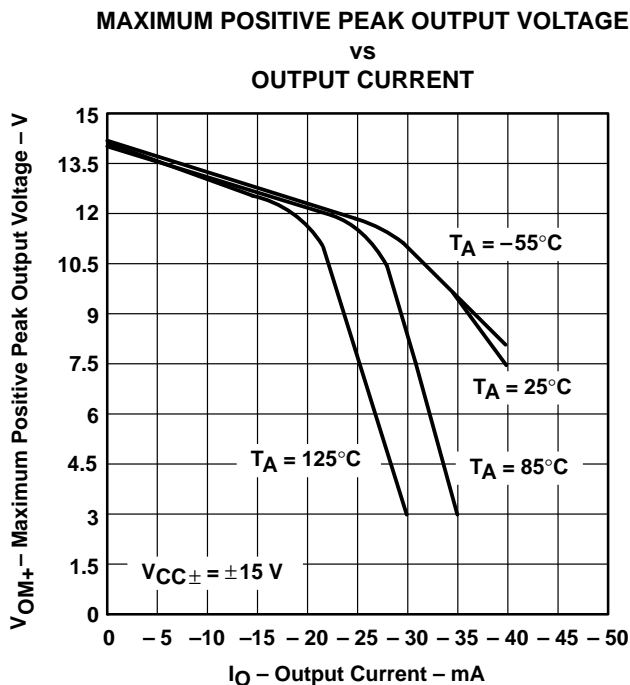

Figure 14

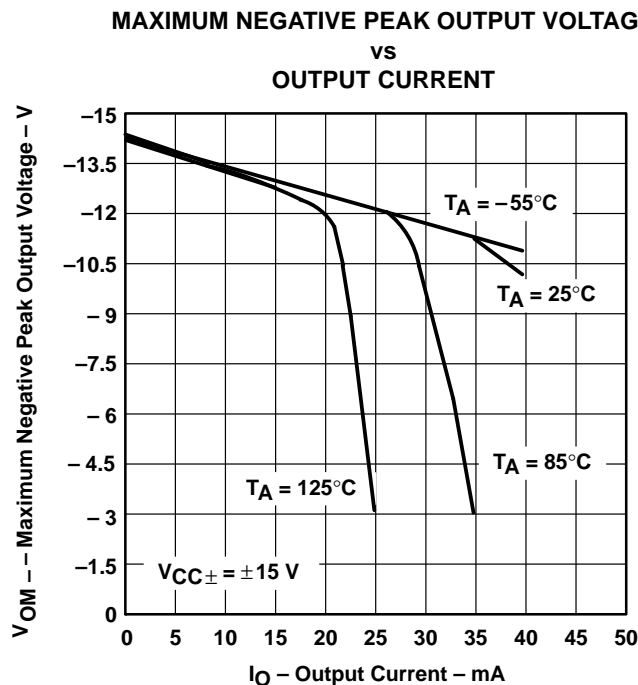

Figure 15

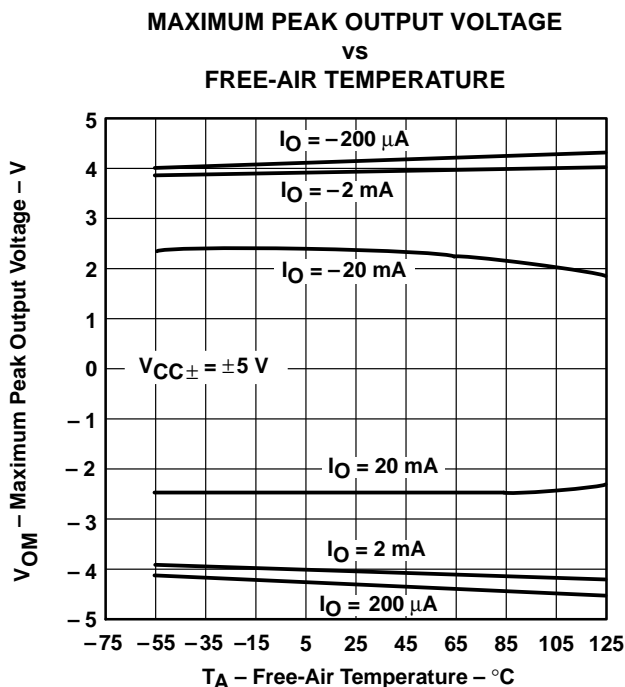

Figure 16

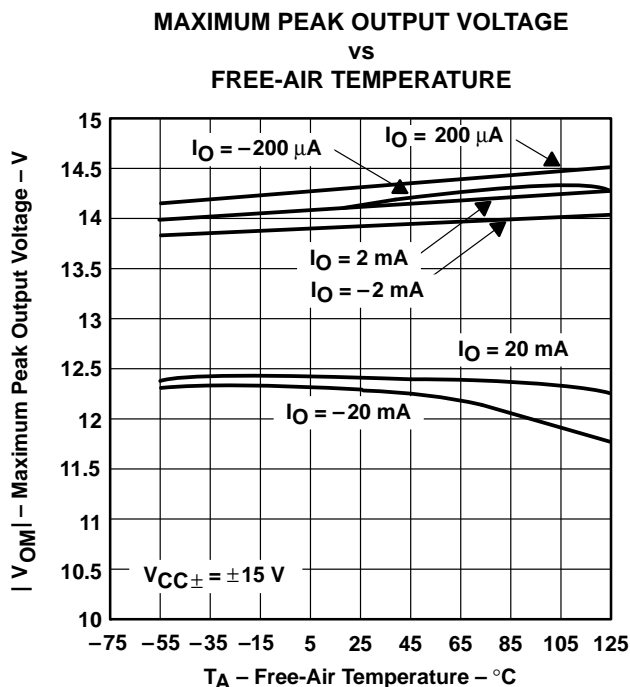

Figure 17

† Data at high and low temperatures are applicable only within the rated operating free-air temperature ranges of the various devices.

TYPICAL CHARACTERISTICS†

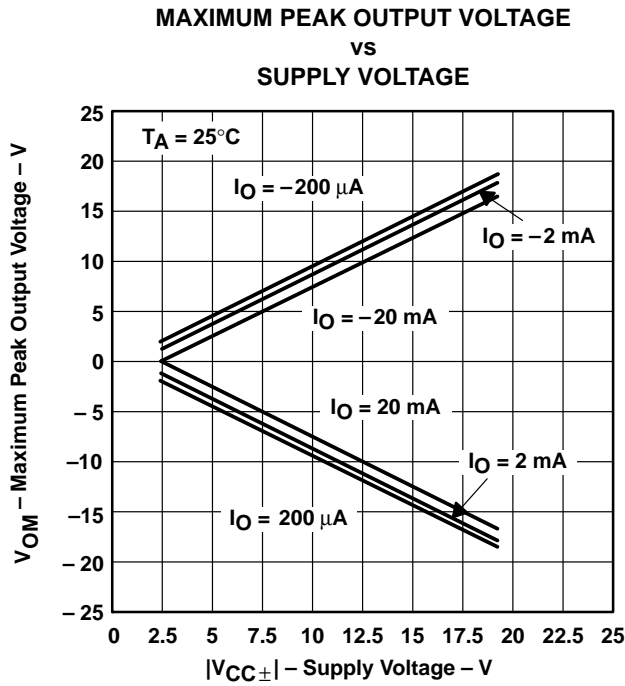

Figure 18

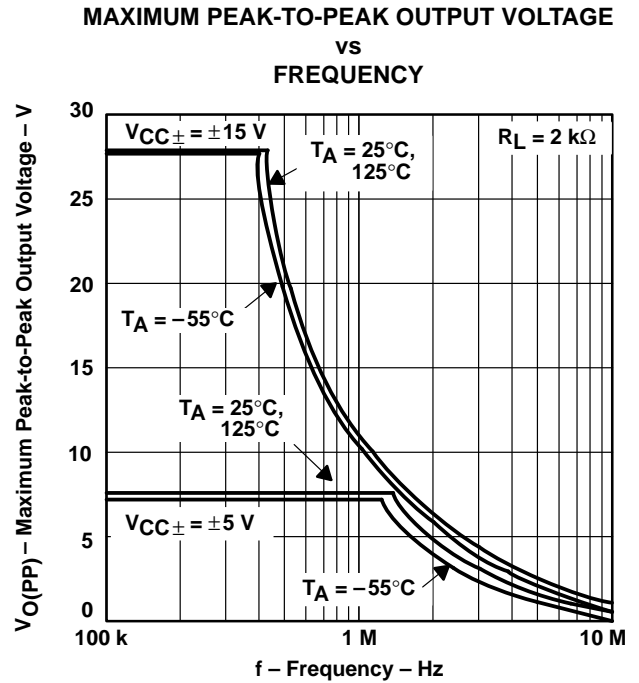

Figure 19

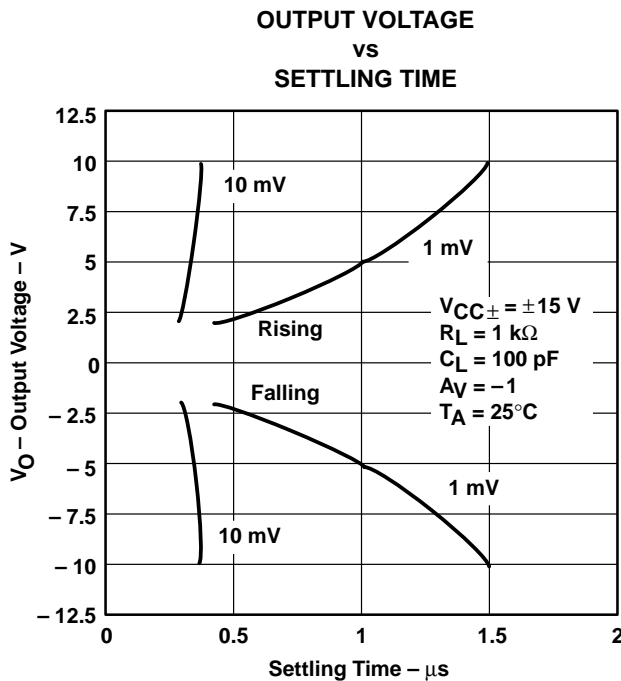

Figure 20

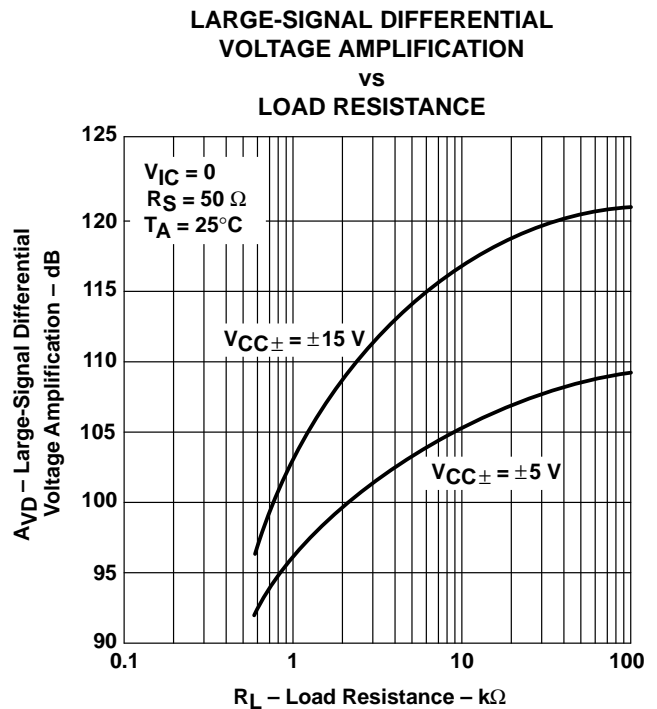
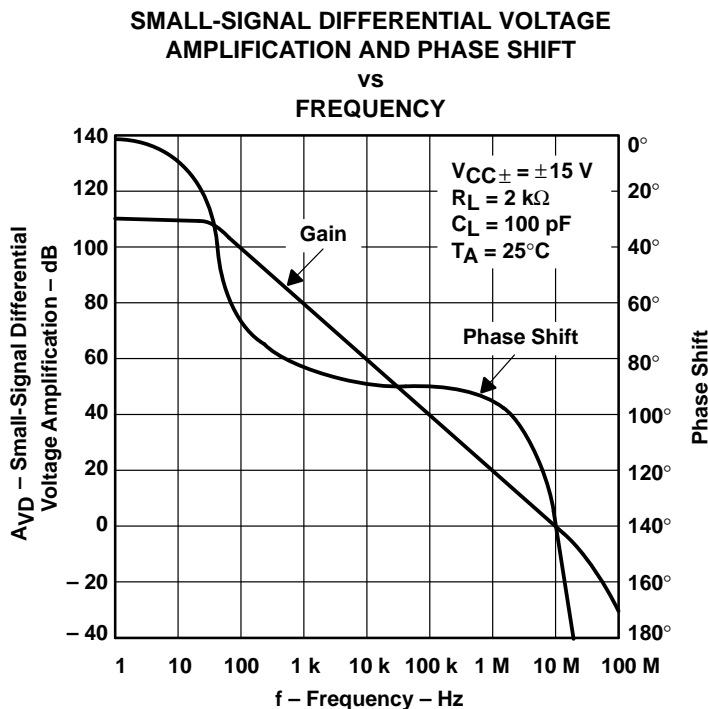
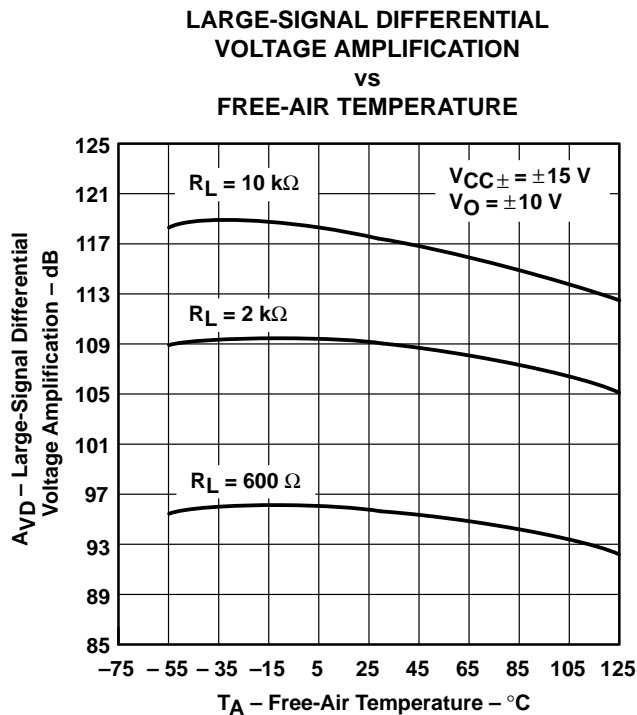
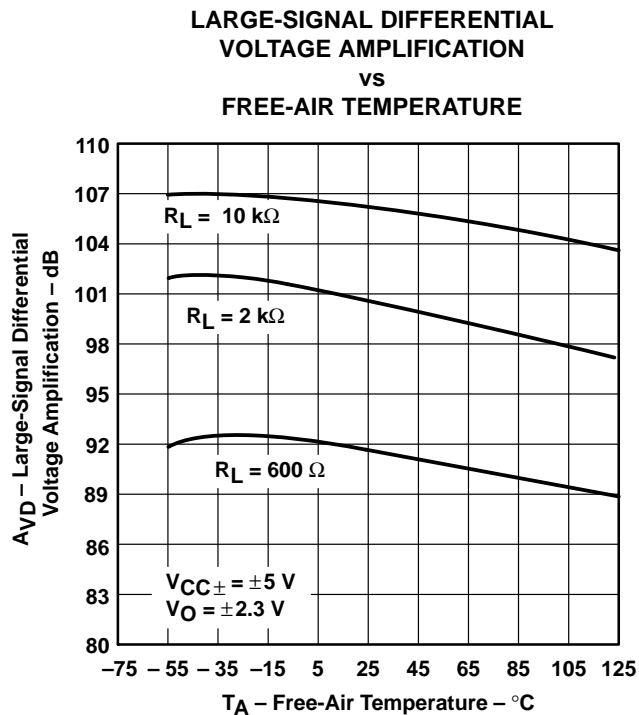

Figure 21

† Data at high and low temperatures are applicable only within the rated operating free-air temperature ranges of the various devices.

TYPICAL CHARACTERISTICS†



† Data at high and low temperatures are applicable only within the rated operating free-air temperature ranges of the various devices.

TLE2071, TLE2071A, TLE2071Y
 EXCALIBUR LOW-NOISE HIGH-SPEED
 JFET-INPUT OPERATIONAL AMPLIFIERS

SLOS119A – JUNE 1993 – REVISED AUGUST 1994

TYPICAL CHARACTERISTICS†

SMALL-SIGNAL DIFFERENTIAL VOLTAGE
 AMPLIFICATION AND PHASE SHIFT

vs
 FREQUENCY

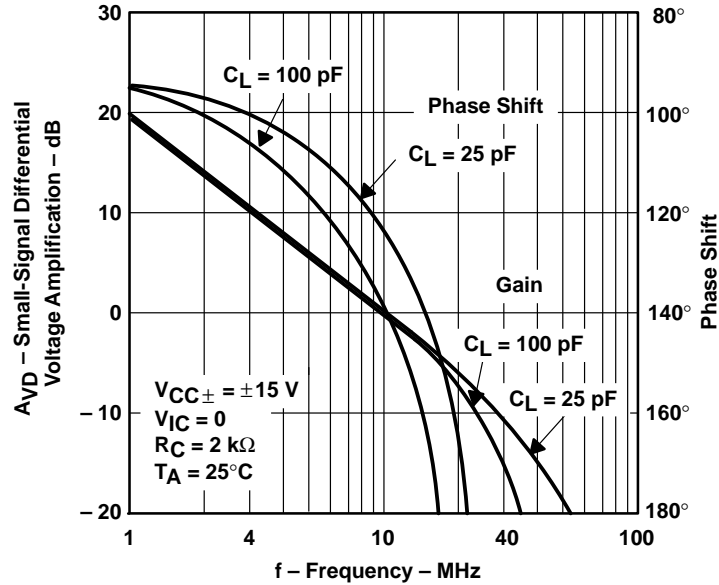

Figure 25

COMMON-MODE REJECTION RATIO
 vs
 FREQUENCY

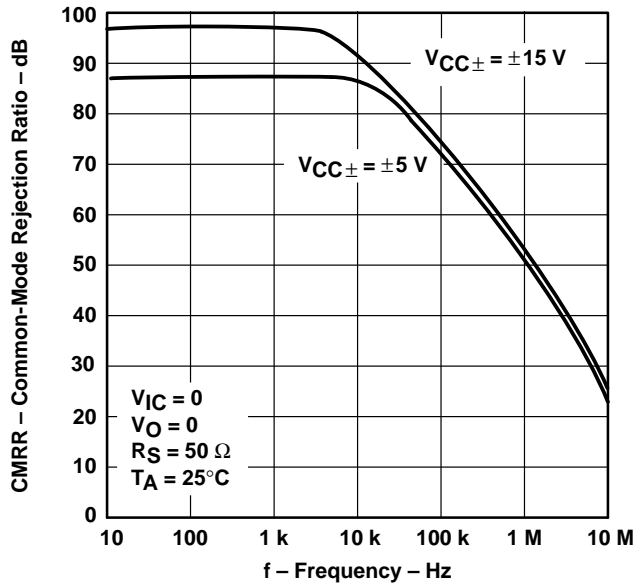

Figure 26

COMMON-MODE REJECTION RATIO
 vs
 FREE-AIR TEMPERATURE

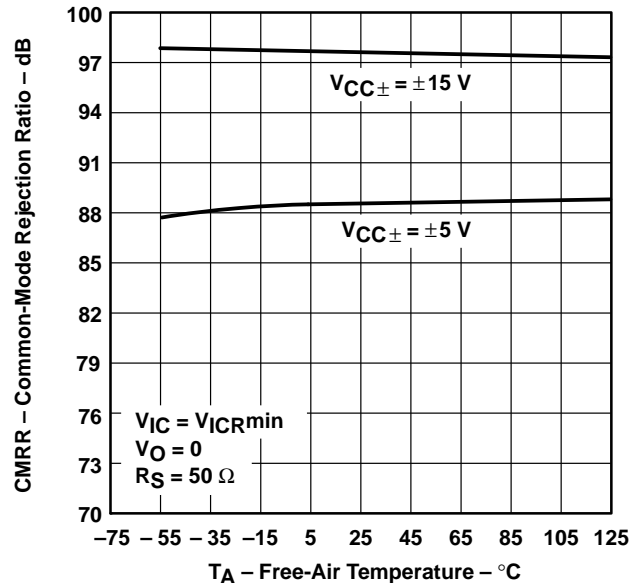
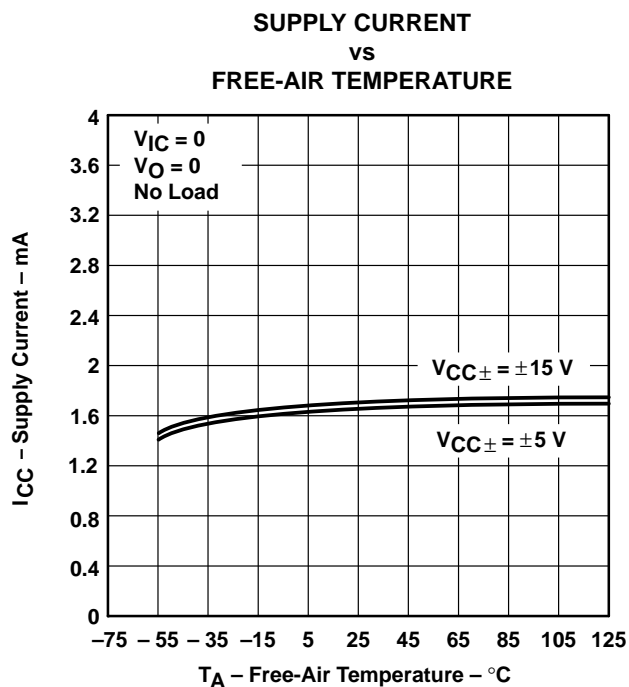
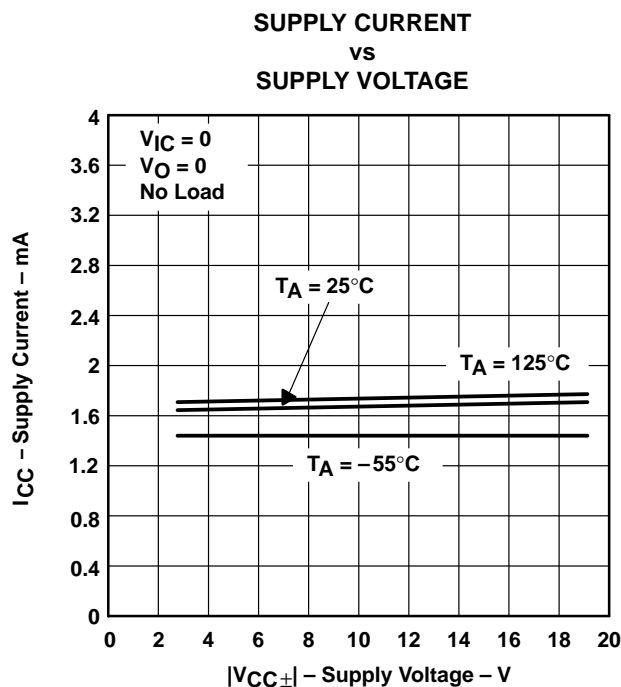
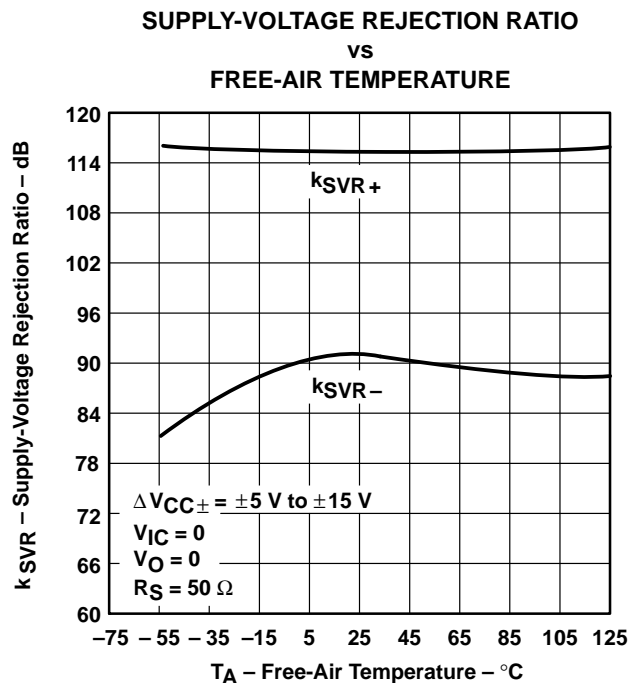
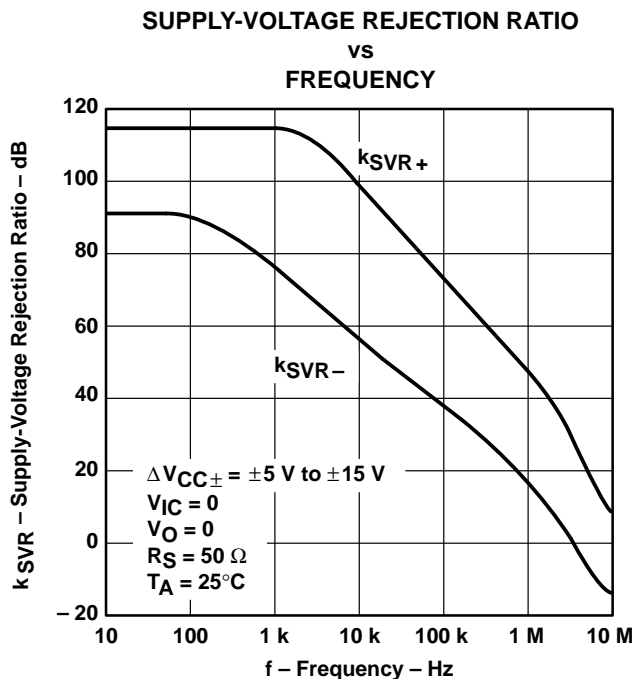

Figure 27

† Data at high and low temperatures are applicable only within the rated operating free-air temperature ranges of the various devices.

TYPICAL CHARACTERISTICS†



† Data at high and low temperatures are applicable only within the rated operating free-air temperature ranges of the various devices.

TYPICAL CHARACTERISTICS

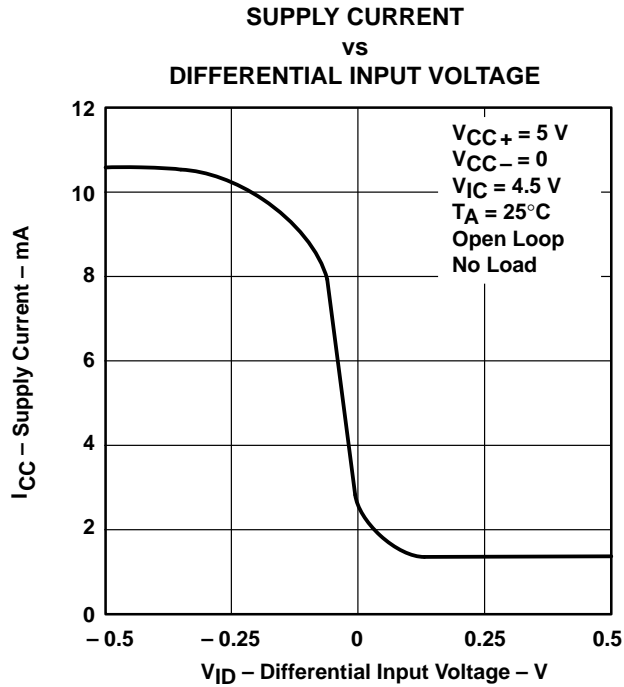

Figure 32

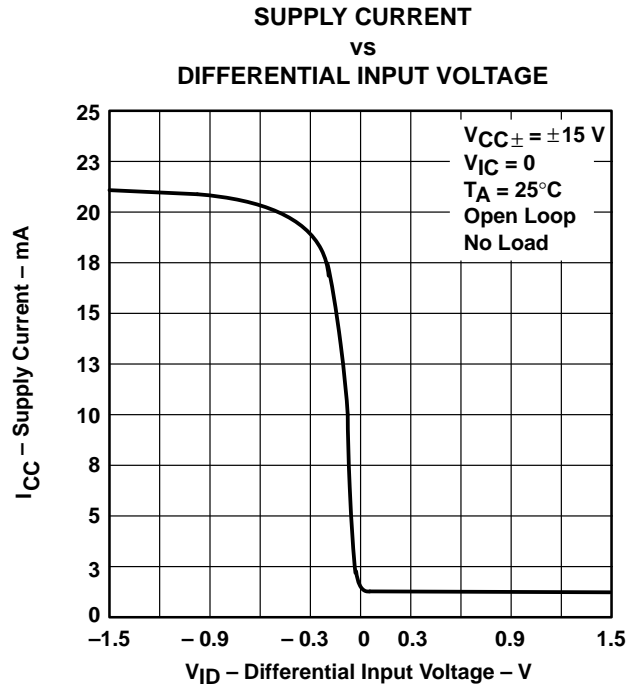

Figure 33

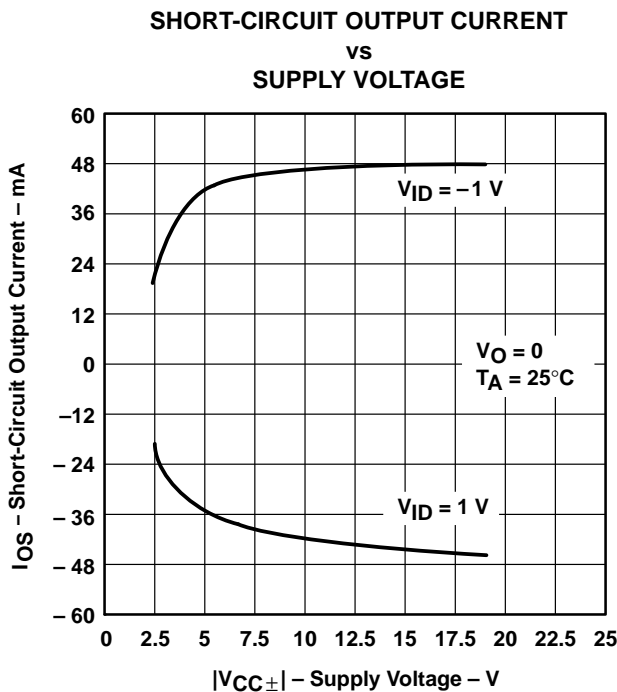

Figure 34

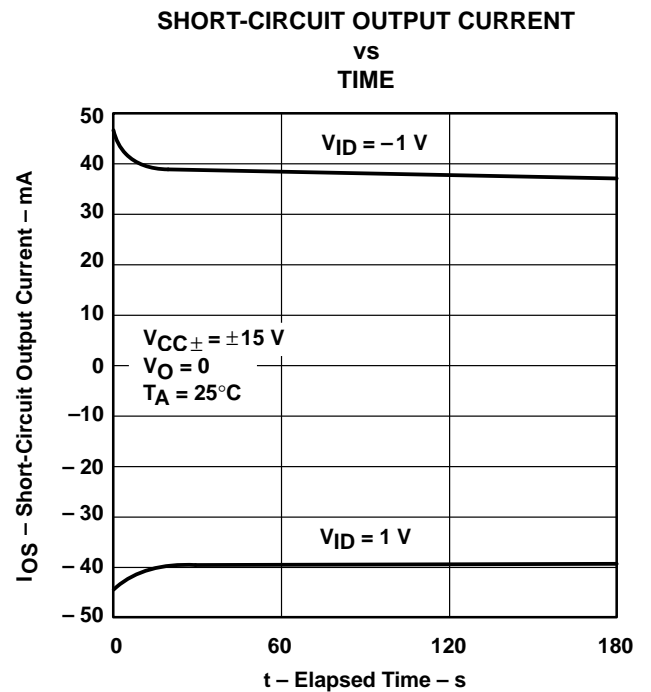

Figure 35

TYPICAL CHARACTERISTICS†

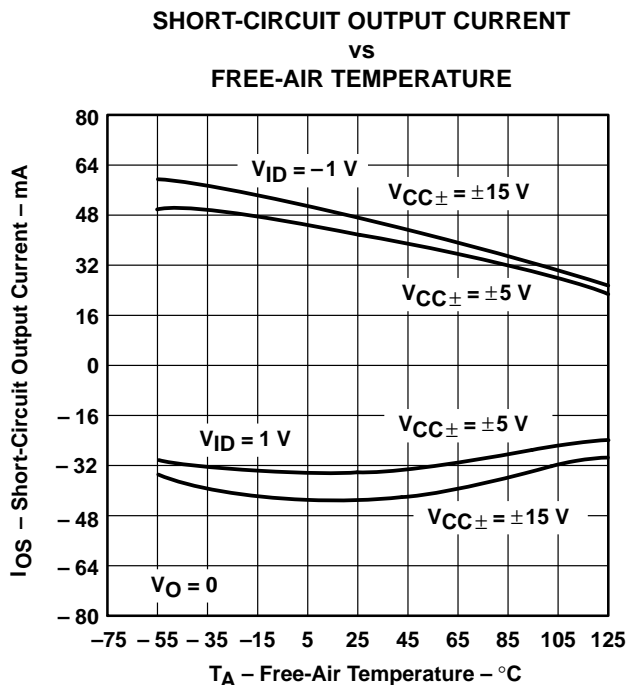

Figure 36

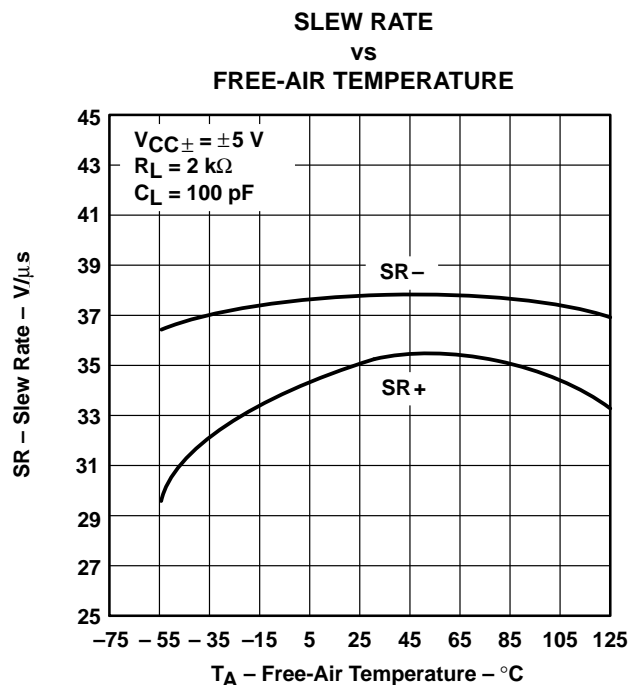

Figure 37

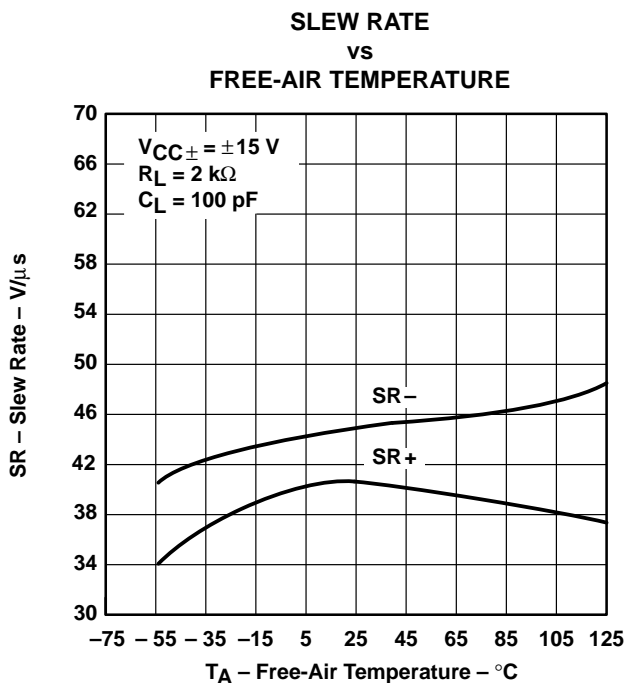

Figure 38

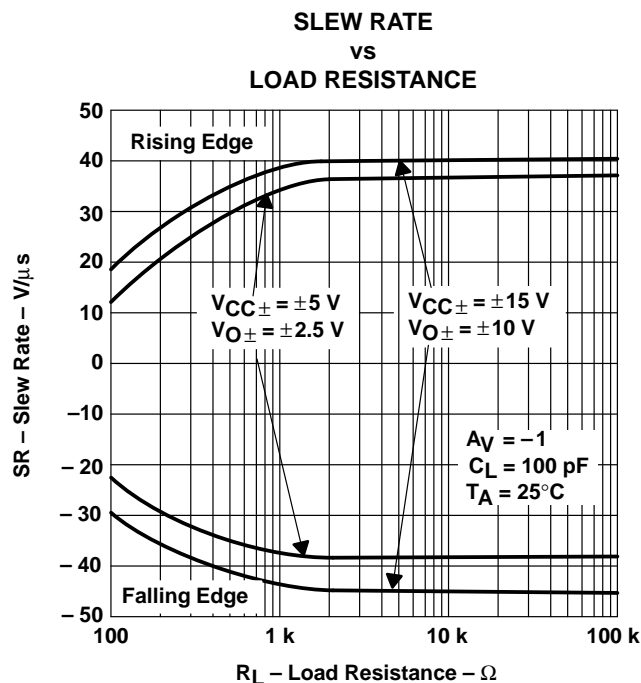
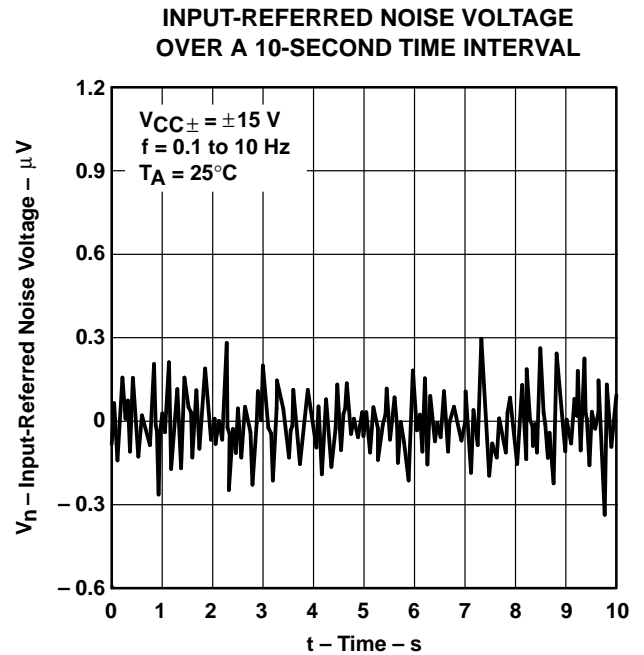
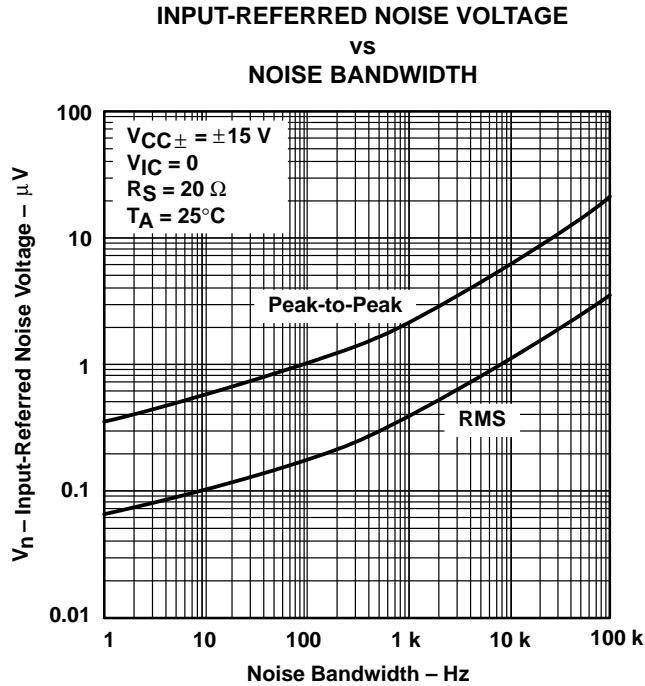
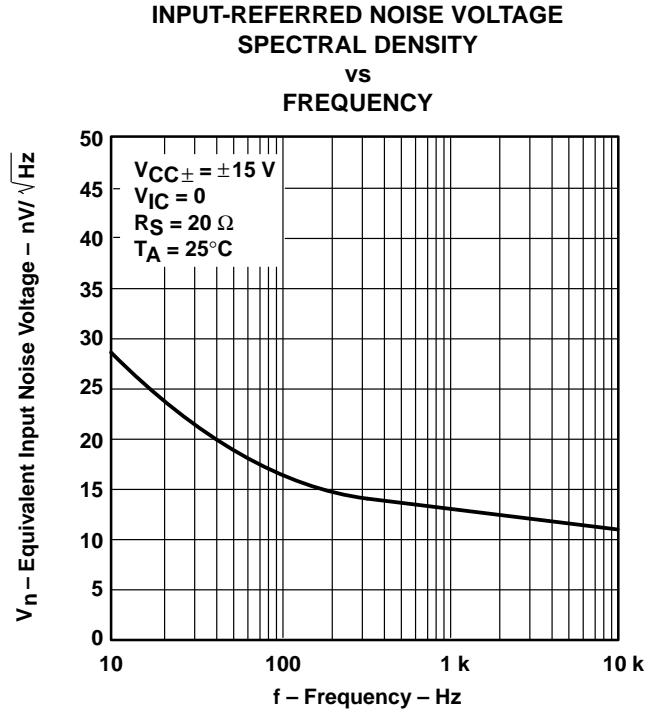
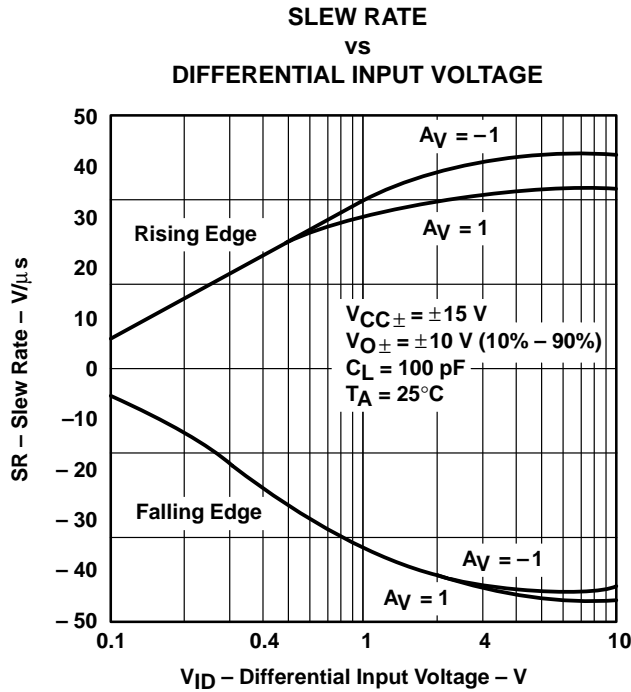

Figure 39

† Data at high and low temperatures are applicable only within the rated operating free-air temperature ranges of the various devices.

TYPICAL CHARACTERISTICS



TYPICAL CHARACTERISTICS

THIRD-OCTAVE SPECTRAL NOISE DENSITY
 vs
 FREQUENCY BANDS

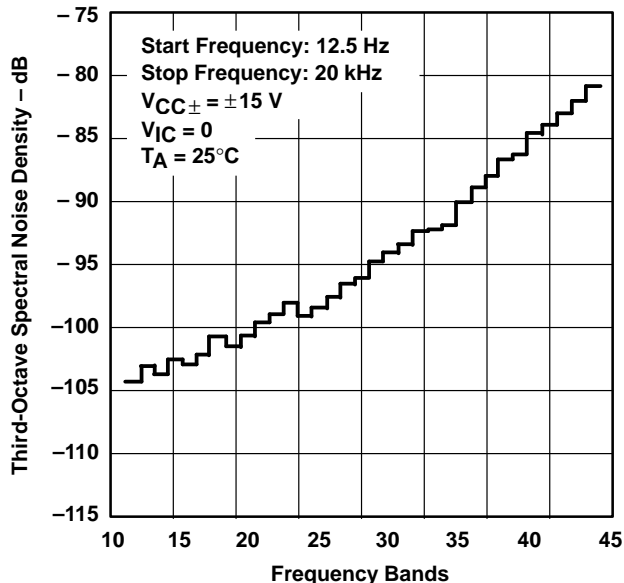

Figure 44

TOTAL HARMONIC DISTORTION PLUS
 NOISE
 vs
 FREQUENCY

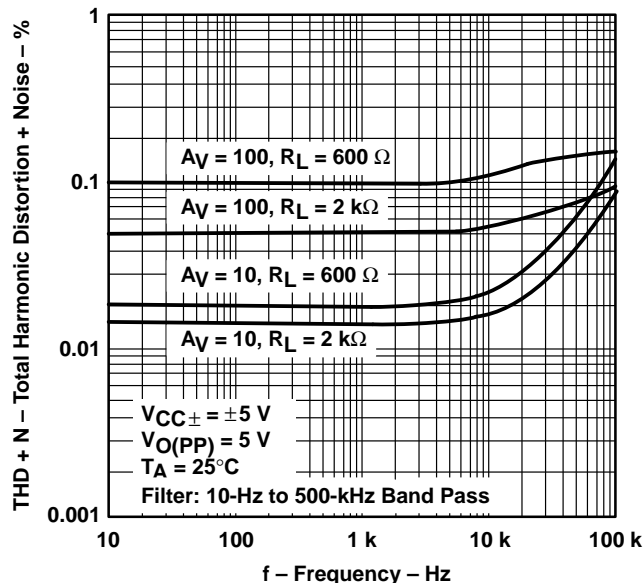

Figure 45

TOTAL HARMONIC DISTORTION PLUS NOISE
 vs
 FREQUENCY

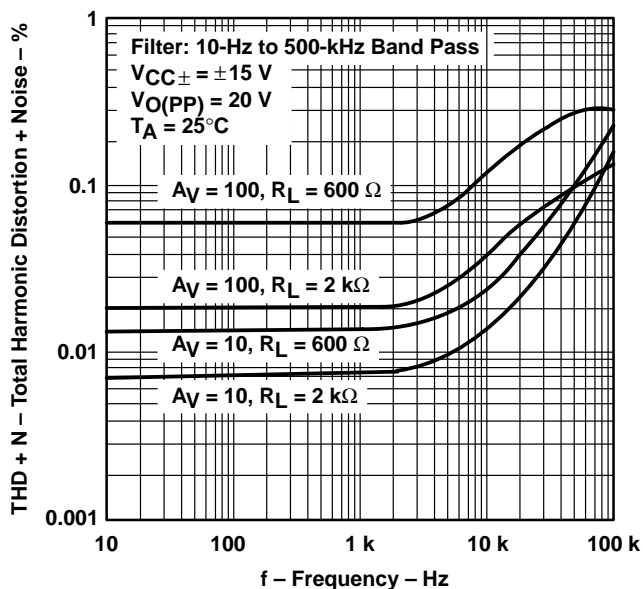

Figure 46

UNITY-GAIN BANDWIDTH
 vs
 LOAD CAPACITANCE

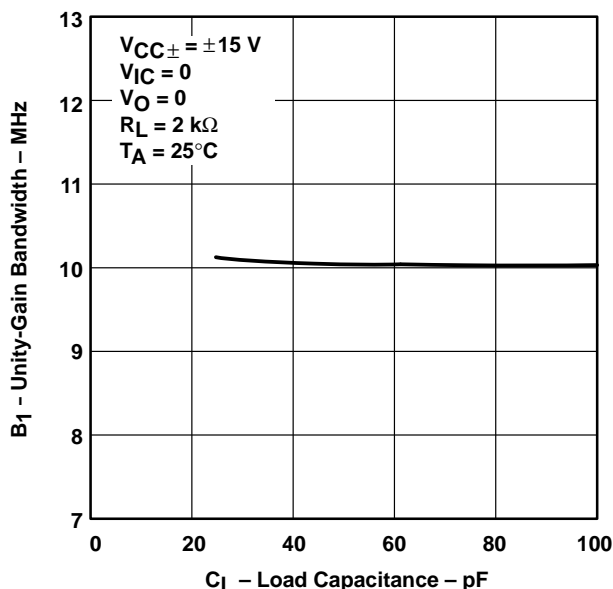
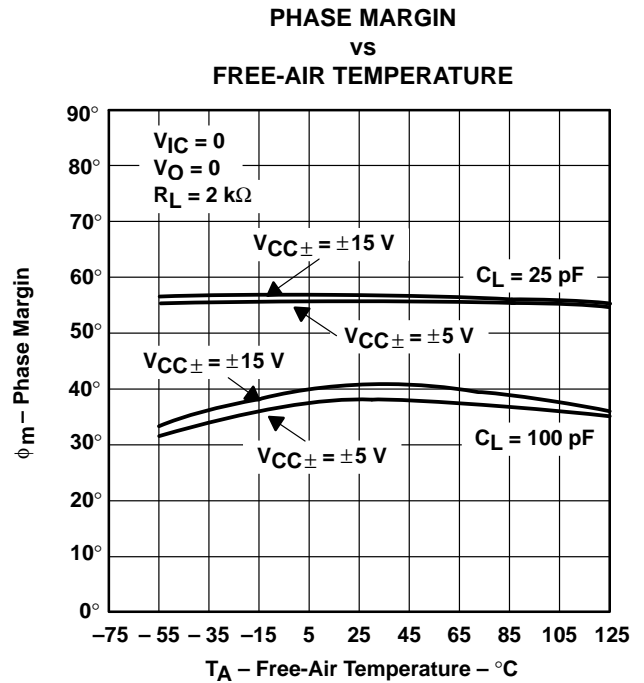
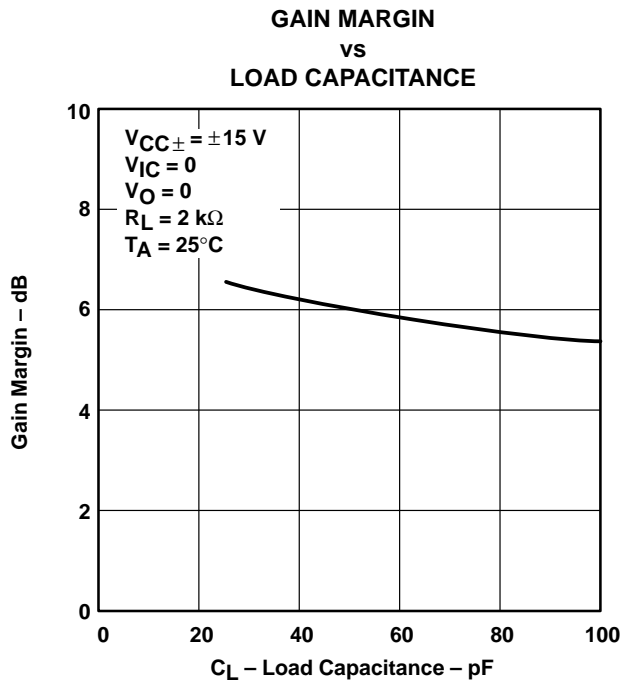
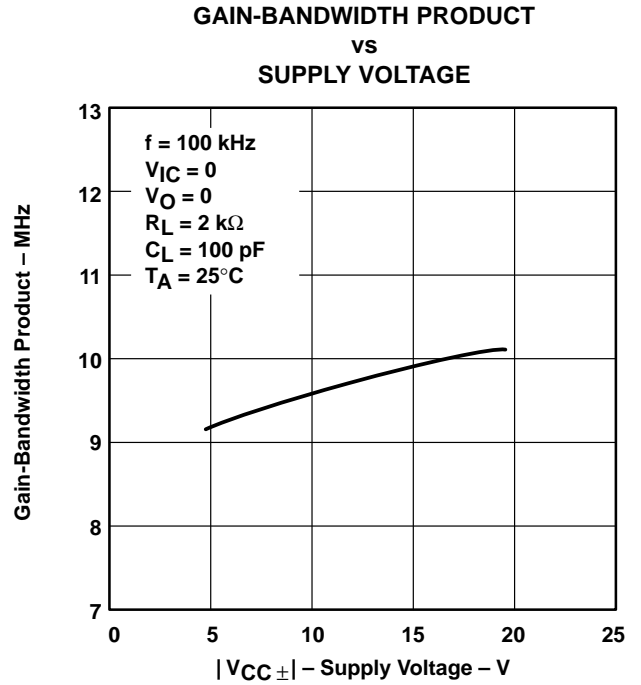
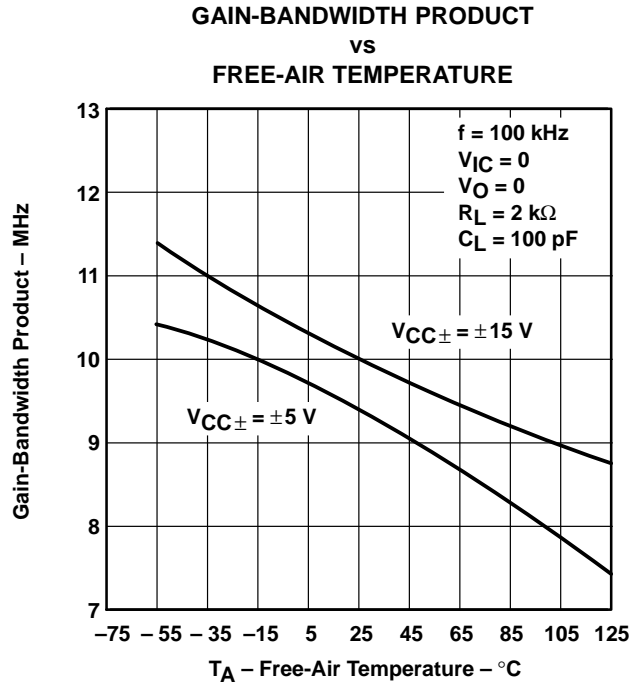

Figure 47

TYPICAL CHARACTERISTICS†



† Data at high and low temperatures are applicable only within the rated operating free-air temperature ranges of the various devices.

TYPICAL CHARACTERISTICS

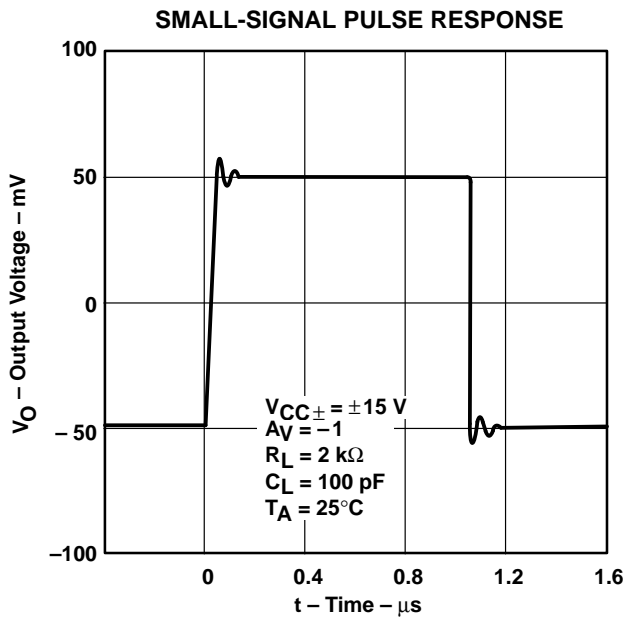
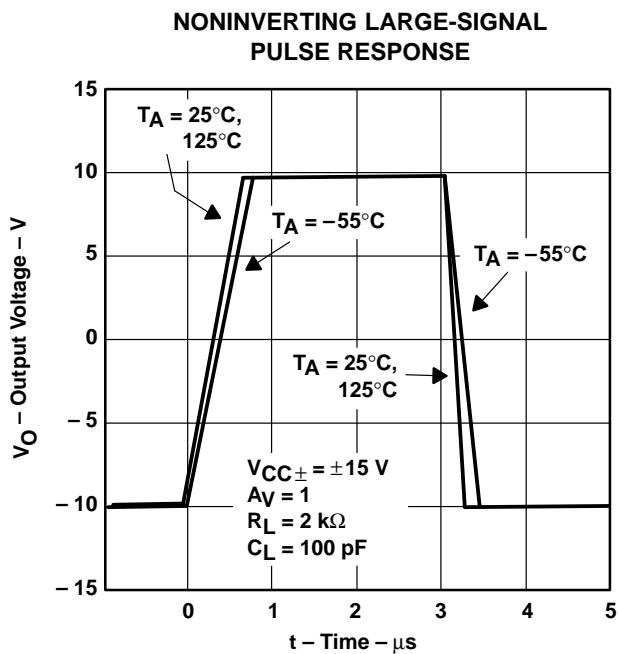
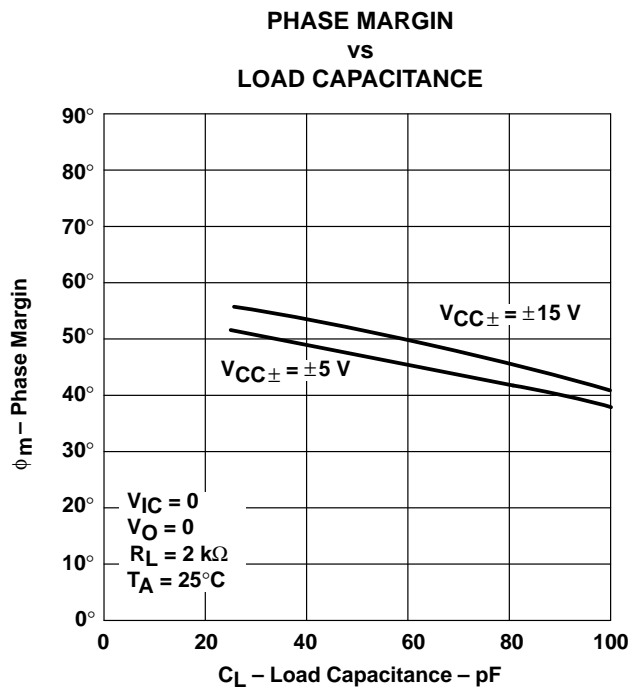
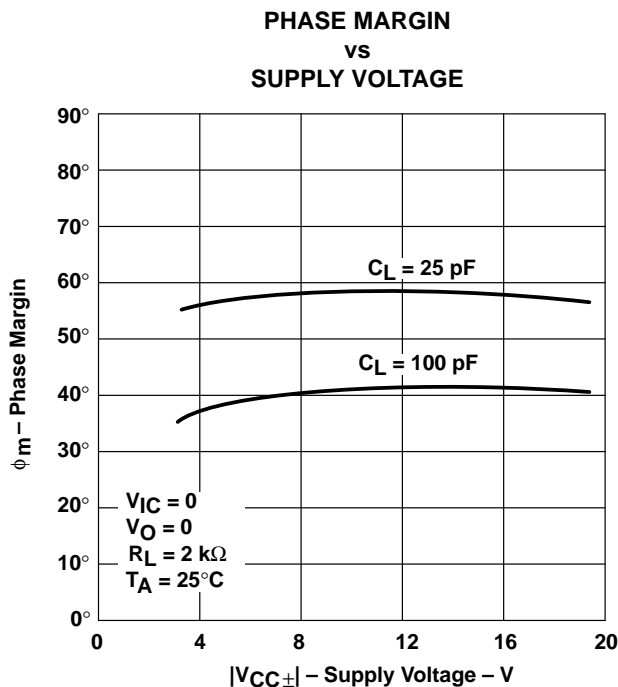

TYPICAL CHARACTERISTICS
CLOSED-LOOP OUTPUT IMPEDANCE
VS
FREQUENCY

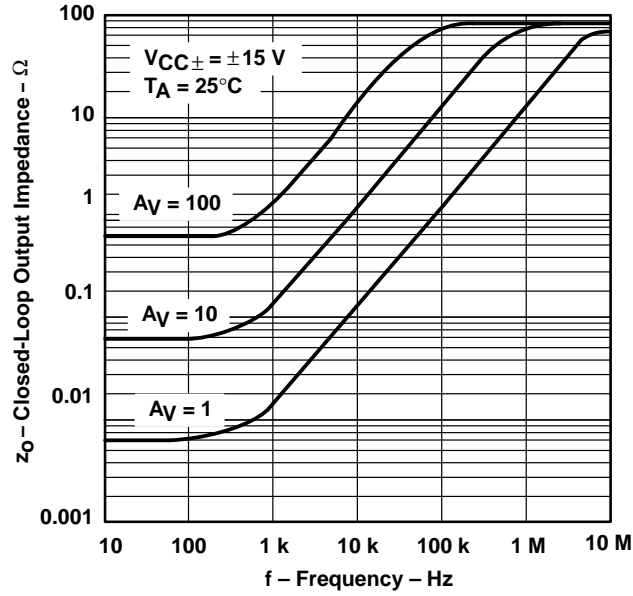

Figure 56

APPLICATION INFORMATION

macromodel information

Macromodel information provided was derived using *PSpice™ Parts™* model generation software. The Boyle macromodel (see Note 4) and subcircuit in Figure 57 were generated using the TLE2071 typical electrical and operating characteristics at $T_A = 25^\circ\text{C}$. Using this information, output simulations of the following key parameters can be generated to a tolerance of 20% (in most cases):

- Maximum positive output voltage swing
- Maximum negative output voltage swing
- Slew rate
- Quiescent power dissipation
- Input bias current
- Open-loop voltage amplification
- Unity-gain frequency
- Common-mode rejection ratio
- Phase margin
- DC output resistance
- AC output resistance
- Short-circuit output current limit

NOTE 4: G.R. Boyle, B.M. Cohn, D. O. Pederson, and J. E. Solomon, "Macromodeling of Integrated Circuit Operational Amplifiers", *IEEE Journal of Solid-State Circuits*, SC-9, 353 (1974).

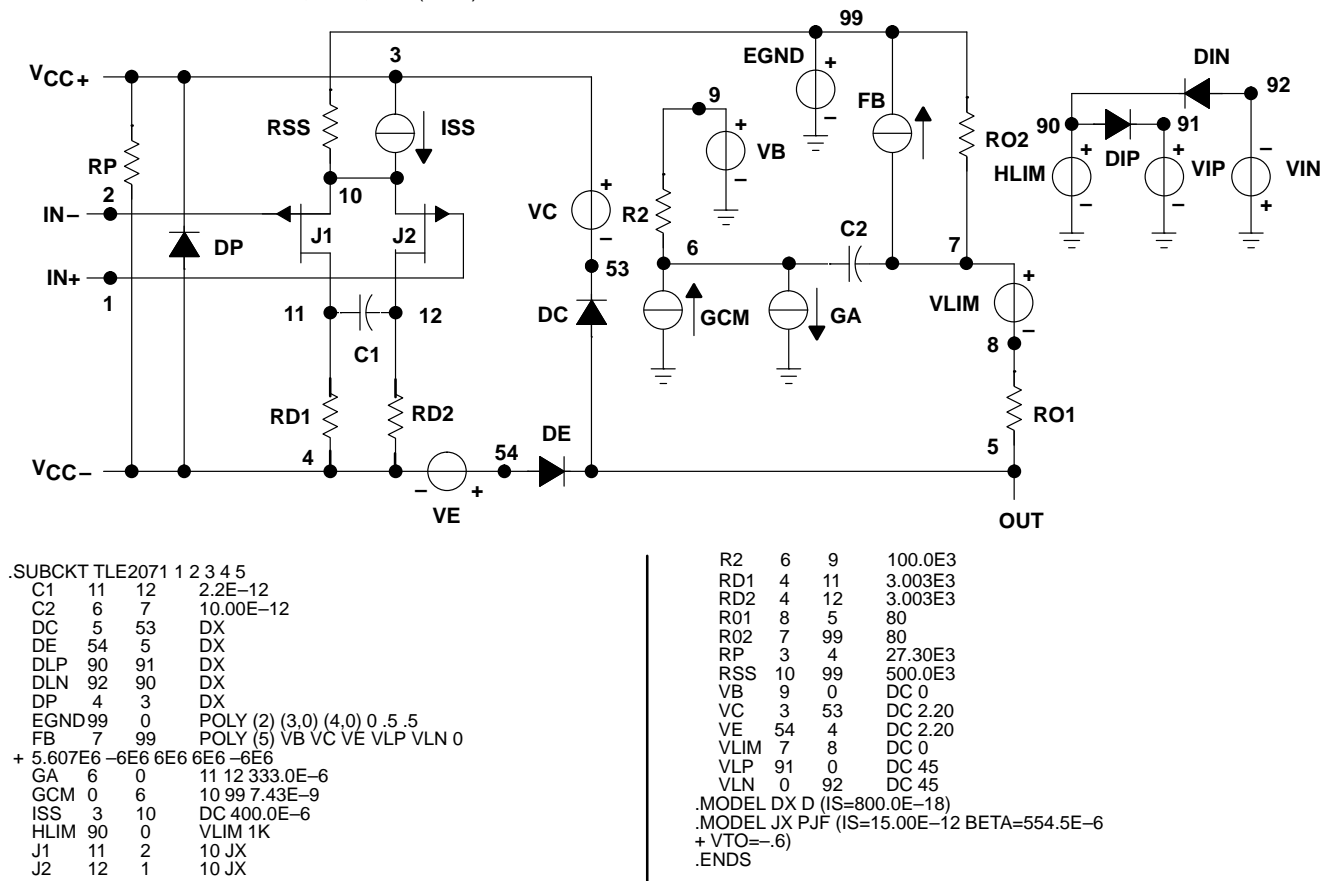

Figure 57. Boyle Macromodel and Subcircuit

PSpice and *Parts* are registered trademarks of MicroSim Corporation.

IMPORTANT NOTICE

Texas Instruments (TI) reserves the right to make changes to its products or to discontinue any semiconductor product or service without notice, and advises its customers to obtain the latest version of relevant information to verify, before placing orders, that the information being relied on is current.

TI warrants performance of its semiconductor products and related software to the specifications applicable at the time of sale in accordance with TI's standard warranty. Testing and other quality control techniques are utilized to the extent TI deems necessary to support this warranty. Specific testing of all parameters of each device is not necessarily performed, except those mandated by government requirements.

Certain applications using semiconductor products may involve potential risks of death, personal injury, or severe property or environmental damage ("Critical Applications").

TI SEMICONDUCTOR PRODUCTS ARE NOT DESIGNED, INTENDED, AUTHORIZED, OR WARRANTED TO BE SUITABLE FOR USE IN LIFE-SUPPORT APPLICATIONS, DEVICES OR SYSTEMS OR OTHER CRITICAL APPLICATIONS.

Inclusion of TI products in such applications is understood to be fully at the risk of the customer. Use of TI products in such applications requires the written approval of an appropriate TI officer. Questions concerning potential risk applications should be directed to TI through a local SC sales office.

In order to minimize risks associated with the customer's applications, adequate design and operating safeguards should be provided by the customer to minimize inherent or procedural hazards.

TI assumes no liability for applications assistance, customer product design, software performance, or infringement of patents or services described herein. Nor does TI warrant or represent that any license, either express or implied, is granted under any patent right, copyright, mask work right, or other intellectual property right of TI covering or relating to any combination, machine, or process in which such semiconductor products or services might be or are used.