

GaAs MMIC DOUBLE-BALANCED MIXER, 25 - 40 GHz

Typical Applications

The HMC329 is ideal for:

- LMDS
- Microwave Point-to-Point Radios
- SATCOM

Features

- Passive: No DC Bias Required
- Input IP3: +19 dBm
- LO/RF Isolation: 42 dB
- Small Size: 0.47 mm²

Functional Diagram

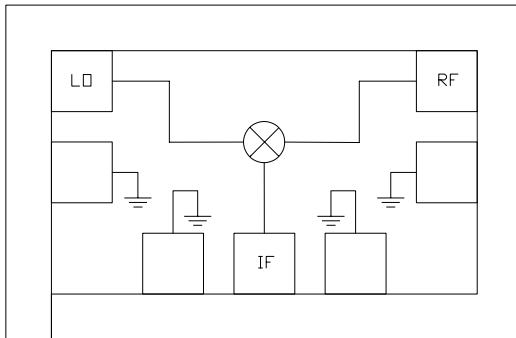

General Description

The HMC329 chip is a miniature passive double balanced mixer which can be used as an upconverter or downconverter from 25-40 GHz in a small chip area of 0.84mm x 0.55mm. Excellent isolations are provided by on-chip baluns, and the chip requires no external components and no DC bias. Measurements were made with the chip mounted and ribbon bonded into in a 50-ohm microstrip test fixture that contains 5-mil alumina substrates between the chip and K-connectors. Measured data includes the parasitic effects of the assembly. RF connections to the chip were made with 0.076 mm (3-mil) ribbon bond with minimal length <0.31mm (<12 mil).

Electrical Specifications, $T_A = +25^\circ C$

Parameter	LO = +13 dBm, IF = 1 GHz			Units
	Min.	Typ.	Max.	
Frequency Range, RF & LO	25 - 40			GHz
Frequency Range, IF	DC - 8			GHz
Conversion Loss		9.5	11.5	dB
Noise Figure (SSB)		9.5	11.5	dB
LO to RF Isolation	38	42		dB
LO to IF Isolation	25	35		dB
RF to IF Isolation	21	28		dB
IP3 (Input)	16	19		dBm
IP2 (Input)	45	55		dBm
1 dB Compression (Input)	8	11		dBm

* Unless otherwise noted, all measurements performed as downconverter, IF= 1 GHz.

**GaAs MMIC DOUBLE-BALANCED
MIXER, 25 - 40 GHz**

**Conversion Gain vs.
Temperature @ LO = +13 dBm**

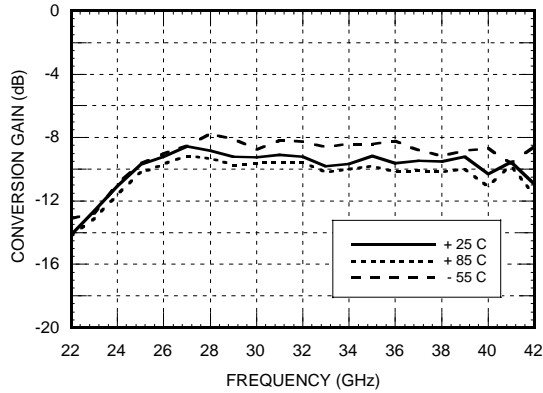

Isolation @ LO = +13 dBm

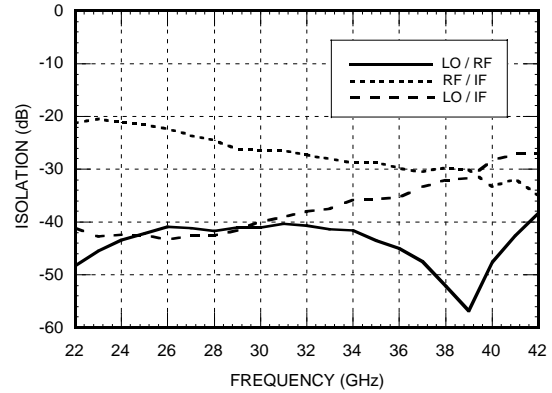

Conversion Gain vs. LO Drive

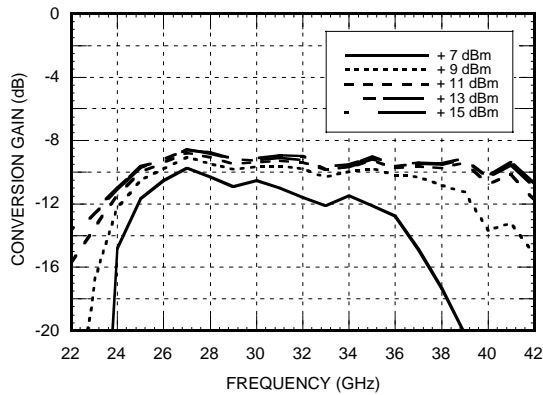

**Upconverter Performance
Conversion Gain @ LO = +13 dBm**

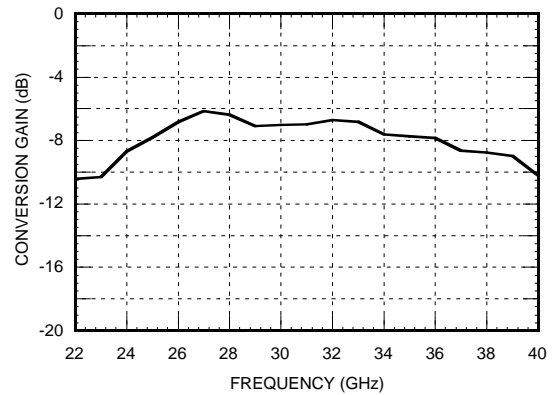

IF Bandwidth @ LO = +13 dBm

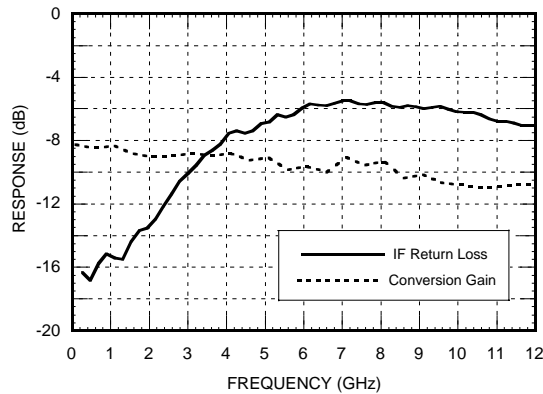

GaAs MMIC DOUBLE-BALANCED MIXER, 25 - 40 GHz

Input IP3 vs. LO Drive *

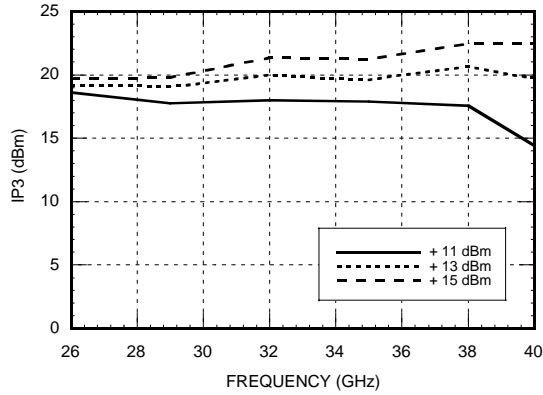

Input IP3 vs. Temperature @ LO = +13 dBm *

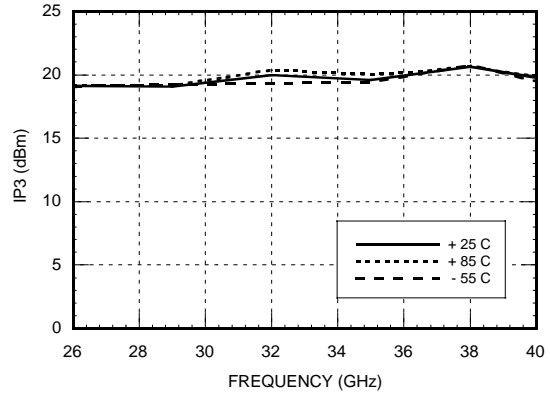

Input IP2 vs. LO Drive *

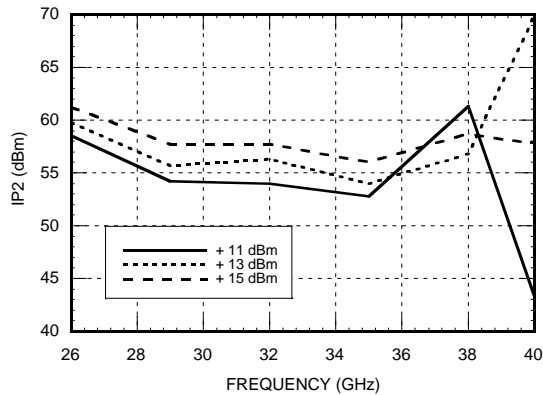

Input IP2 vs. Temperature @ LO = +13 dBm *

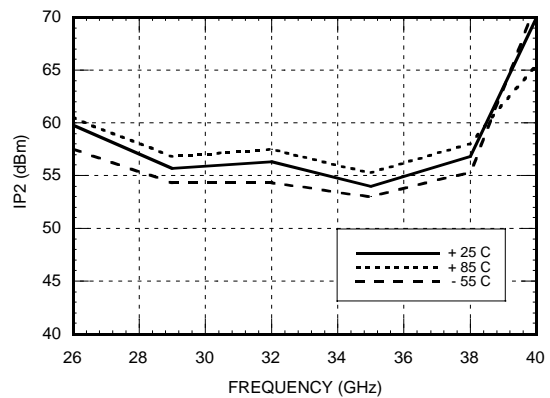

MxN Spurious Outputs as a Down Converter

	nLO				
mRF	0	1	2	3	4
0	xx	7			
1	19	0	41		
2		69	57	67	
3			74	69	71
4				74	74

RF = 31 GHz @ -10 dBm
 LO = 32 GHz @ +13 dBm
 All values in dBc below IF output power level.

Input P1dB vs. Temperature @ LO = +13 dBm

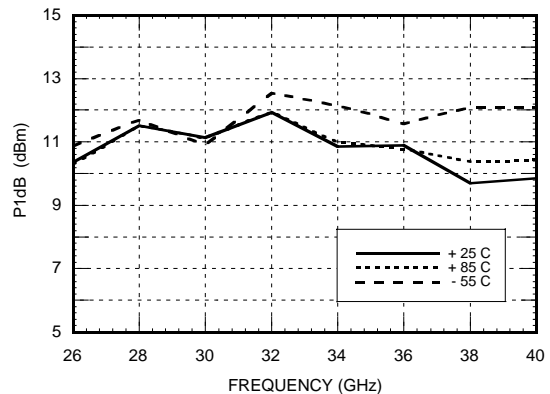

* Two-tone input power = -5 dBm each tone, 1 MHz spacing.

GaAs MMIC DOUBLE-BALANCED MIXER, 25 - 40 GHz

Absolute Maximum Ratings

RF / IF Input	+13 dBm
LO Drive	+27 dBm
IF DC Current	±2 mA
Storage Temperature	-65 to +150 °C
Operating Temperature	-55 to +85 °C

Outline Drawing (See Die Handling, Mounting, Bonding Note)

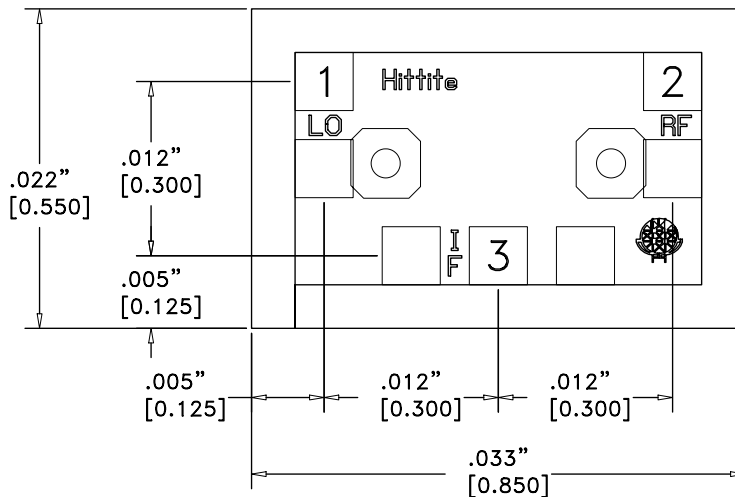

NOTES:

1. ALL DIMENSIONS ARE IN INCHES [MM].
2. DIE THICKNESS IS .004".
3. TYPICAL BOND PAD IS .004" SQUARE.
4. BACKSIDE METALLIZATION: GOLD.
5. BOND PAD METALLIZATION: GOLD.
6. BACKSIDE METAL IS GROUND.
7. CONNECTION NOT REQUIRED FOR UNLABELED BOND PADS.

**GaAs MMIC DOUBLE-BALANCED
MIXER, 25 - 40 GHz**

MIC Assembly Techniques

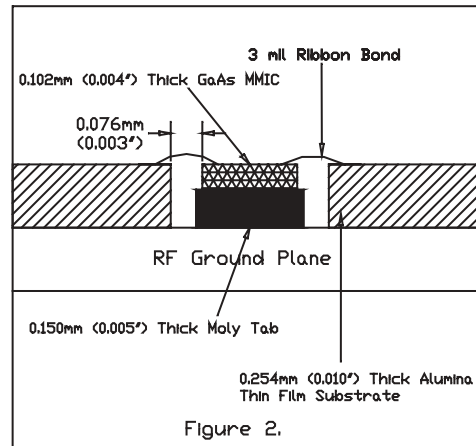
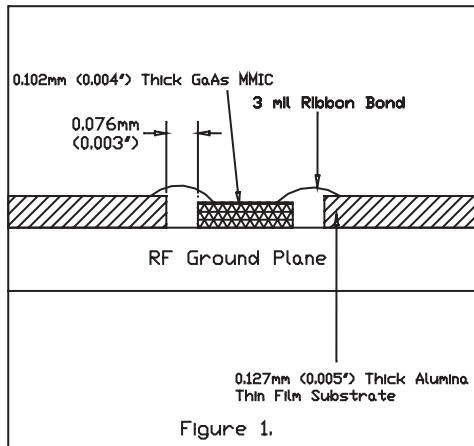

Mounting & Bonding Techniques for Millimeterwave GaAs MMICs

The die should be attached directly to the ground plane eutectically or with conductive epoxy (see HMC general Handling, Mounting, Bonding Note).

50 Ohm Microstrip transmission lines on 0.127mm (5 mil) thick alumina thin film substrates are recommended for bringing RF to and from the chip (Figure 1). If 0.254mm (10 mil) thick alumina thin film substrates must be used, the die should be raised 0.150mm (6 mils) so that the surface of the die is coplanar with the surface of the substrate. One way to accomplish this is to attach the 0.102mm (4 mil) thick die to a 0.150mm (6 mil) thick molybdenum heat spreader (moly-tab) which is then attached to the ground plane (Figure 2).

Microstrip substrates should be brought as close to the die as possible in order to minimize ribbon bond length. Typical die-to-substrate spacing is 0.076mm (3 mils). Gold ribbon of 0.075 mm (3 mil) width and minimal length <0.31 mm (<12 mils) is recommended to minimize inductance on RF, LO & IF ports.

**GaAs MMIC DOUBLE-BALANCED
MIXER, 25 - 40 GHz****Handling Precautions**

Follow these precautions to avoid permanent damage.

Cleanliness: Handle the chips in a clean environment. DO NOT attempt to clean the chip using liquid cleaning systems.

Static Sensitivity: Follow ESD precautions to protect against $> \pm 250V$ ESD strikes.

Transients: Suppress instrument and bias supply transients while bias is applied. Use shielded signal and bias cables to minimize inductive pick-up.

General Handling: Handle the chip along the edges with a vacuum collet or with a sharp pair of bent tweezers. The surface of the chip has fragile air bridges and should not be touched with vacuum collet, tweezers, or fingers.

Mounting

The chip is back-metallized and can be die mounted with AuSn eutectic preforms or with electrically conductive epoxy. The mounting surface should be clean and flat.

Eutectic Die Attach: A 80/20 gold tin preform is recommended with a work surface temperature of 255 °C and a tool temperature of 265 °C. When hot 90/10 nitrogen/hydrogen gas is applied, tool tip temperature should be 290 °C. DO NOT expose the chip to a temperature greater than 320 °C for more than 20 seconds. No more than 3 seconds of scrubbing should be required for attachment.

Epoxy Die Attach: Apply a minimum amount of epoxy to the mounting surface so that a thin epoxy fillet is observed around the perimeter of the chip once it is placed into position. Cure epoxy per the manufacturer's schedule.

Wire Bonding

RF bonds made with 0.003" x 0.0005" ribbon are recommended. These bonds should be thermosonically bonded with a force of 40-60 grams. DC bonds of 0.001" (0.025 mm) diameter, thermosonically bonded, are recommended. Ball bonds should be made with a force of 40-50 grams and wedge bonds at 18-22 grams. All bonds should be made with a nominal stage temperature of 150 °C. A minimum amount of ultrasonic energy should be applied to achieve reliable bonds. All bonds should be as short as possible, less than 12 mils (0.31 mm).