

Fixed Attenuator

50Ω Up to 2W DC to 18 GHz

The Big Deal

- Exceptional Power Handling, Up to 2W
- Wide bandwidth, DC - 18 GHz
- Small Size, 2 mm x 2 mm



CASE STYLE: MC1630

Product Overview

YAT attenuators (ROHS compliant) are fixed value, absorptive attenuators fabricated using highly repetitive MMIC processing including thin film resistors on GaAs substrates. YAT attenuator die contain through-wafer Cu metallization vias to realize low thermal resistance and wideband operation. YATs are available with nominal attenuation values of 0 to 10 dB (in 1 dB steps), and 12, 15, 20, and 30 dB. Packaged in tiny 2 mm x 2 mm MCLP™ package fits into tiny spaces.

Key Features

Feature	Advantages
Wideband operation, DC to 18 GHz	Supports a wide array of applications including wireless cellular, microwave communications, satellite, defense and aerospace, medical broadband and optic applications.
Small Size and simple to use (2 mm x 2 mm)	As a single chip solution, the YAT series occupies less board space than a "T" or "Pi" pad configuration, and ensures repeatable performance over wide frequency ranges.
High Power, Up to 2W	High power handling in a small size package.
Wide range of nominal attenuation values 0 to 10 dB (in 1 dB steps), and 12, 15, 20, and 30 dB	Small increment offering enables circuit designer to change attenuation values without motherboard redesign making the YAT series ideal for select at test application.
MCLP™ Package	Low Inductance, repeatable transitions, excellent thermal path make the YAT series an ideal solution as an alternative to "do it yourself" resistor based attenuators.

Notes

- A. Performance and quality attributes and conditions not expressly stated in this specification document are intended to be excluded and do not form a part of this specification document.
 B. Electrical specifications and performance data contained in this specification document are based on Mini-Circuit's applicable established test performance criteria and measurement instructions.
 C. The parts covered by this specification document are subject to Mini-Circuits standard limited warranty and terms and conditions (collectively, "Standard Terms"); Purchasers of this part are entitled to the rights and benefits contained therein. For a full statement of the Standard Terms and the exclusive rights and remedies thereunder, please visit Mini-Circuits' website at www.minicircuits.com/MCLStore/terms.jsp



Microwave Precision Fixed Attenuator

YAT-12+

50Ω 1.8W 12dB DC to 18 GHz

Product Features

- miniature package MCLP™ 2 x 2 mm
- wide bandwidth, DC-18 GHz
- excellent attenuation accuracy & flatness

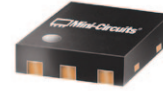

CASE STYLE: MC1630

Typical Applications

- Cellular
- PCS
- communications
- radar
- defense

+RoHS Compliant
The +Suffix identifies RoHS Compliance. See our web site for RoHS Compliance methodologies and qualifications

General Description

YAT-12+ is a 12-dB absorptive attenuator fabricated using highly repetitive MMIC process including thin film resistors on GaAs substrate. YAT-12+ attenuator die contains through-wafer Cu metallization vias to realize low thermal resistance and wideband operation. Packaged in tiny 2 mm x 2 mm MCLP™ package fits into tiny spaces.

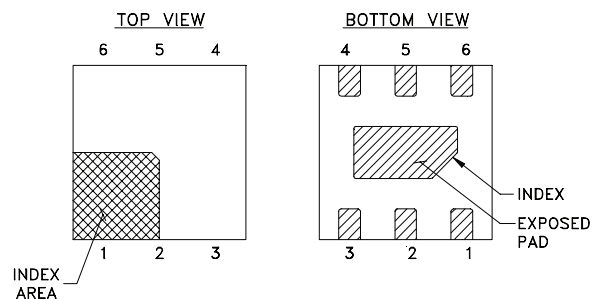

Pad Description

Function	Pad Number	Description
RF IN	2	RF input pad
RF-OUT	5	RF output pad
GND	1,3,4,6 Bottom Exposed pad	Connected to ground externally

Notes

- A. Performance and quality attributes and conditions not expressly stated in this specification document are intended to be excluded and do not form a part of this specification document.
 B. Electrical specifications and performance data contained in this specification document are based on Mini-Circuit's applicable established test performance criteria and measurement instructions.
 C. The parts covered by this specification document are subject to Mini-Circuits standard limited warranty and terms and conditions (collectively, "Standard Terms"); Purchasers of this part are entitled to the rights and benefits contained therein. For a full statement of the Standard Terms and the exclusive rights and remedies thereunder, please visit Mini-Circuits' website at www.minicircuits.com/MCLStore/terms.jsp



Electrical Specifications¹ at 25°C, 50Ω (CPW)

Parameter	Condition (GHz)	Min.	Typ.	Max.	Unit
Frequency Range		DC	—	18	GHz
Attenuation	0.01	—	12	—	dB
	DC - 5	11.5	12.0	12.5	
	5 - 15	11.6	12.4	13.0	
VSWR	DC - 5	—	1.05	1.38	:1
	5 - 15	—	1.38	1.90	
	15 - 18	—	1.47	1.90	
Input Power ²	DC - 18	—	—	1.8	W

1. Tested on Mini-Circuits test board TB-621-12+ using coplanar wave guide (CPW) input and output traces (see suggested PCB layout on page 4 of this data sheet)
 2. RF Power at 25°C case temperature: 1.8 Watt. Derate linearly to 1.0 W at 85°C.

Absolute Maximum Ratings

Operating Case Temperature ³	-40°C to 85°C
Storage Temperature	-65°C to 150°C
RF Input Power	1.8W

3. Case is defined as ground lead.
 Permanent damage may occur if any of these limits are exceeded.

Characterization Test Circuit

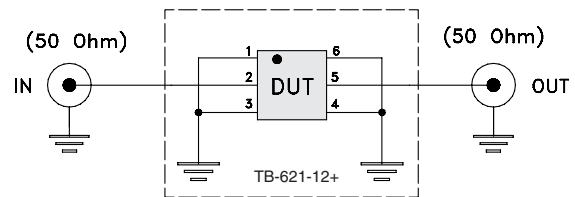
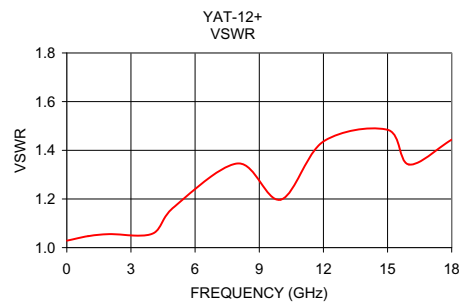
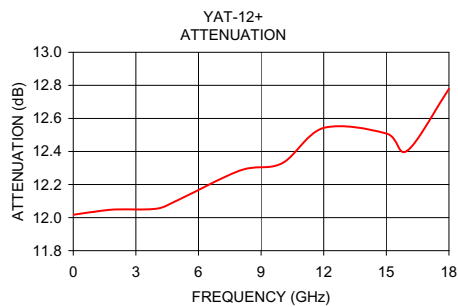

Fig 1. Block diagram of Test Circuit used for characterization, Test board TB-621-12+
 Conditions: Attenuation, VSWR: Pin=-10 dBm

Typical Performance Data at 25°C

Frequency (GHz)	Attenuation (dB)	VSWR (:1)
0.01	12.02	1.03
1.0	12.04	1.05
2.0	12.05	1.06
4.0	12.05	1.06
5.0	12.10	1.17
8.0	12.29	1.35
10.0	12.33	1.20
12.0	12.54	1.44
15.0	12.51	1.48
16.0	12.40	1.34
18.0	12.78	1.44



Notes

- A. Performance and quality attributes and conditions not expressly stated in this specification document are intended to be excluded and do not form a part of this specification document.
- B. Electrical specifications and performance data contained in this specification document are based on Mini-Circuits' applicable established test performance criteria and measurement instructions.
- C. The parts covered by this specification document are subject to Mini-Circuits standard limited warranty and terms and conditions (collectively, "Standard Terms"); Purchasers of this part are entitled to the rights and benefits contained therein. For a full statement of the Standard Terms and the exclusive rights and remedies thereunder, please visit Mini-Circuits' website at www.minicircuits.com/MCLStore/terms.jsp



Suggested PCB Layout (PL-349)

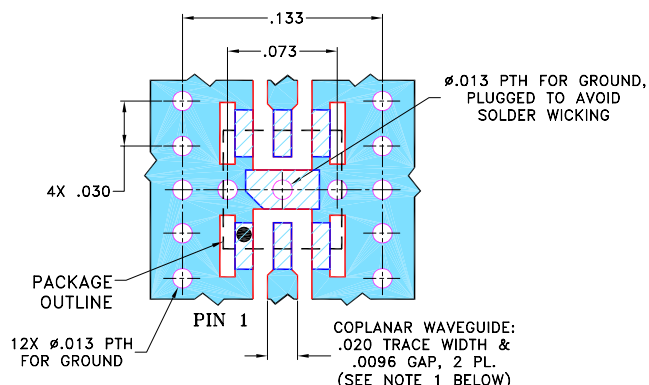

Product Marking

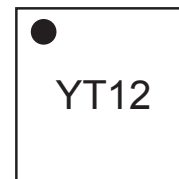

- NOTES: 1. COPLANAR WAVEGUIDE IS SHOWN FOR ROGERS R04350B WITH DIELECTRIC THICKNESS .010" ± .001"; COPPER: 1/2 OZ. EACH SIDE. FOR OTHER MATERIALS TRACE WIDTH MAY NEED TO BE MODIFIED.
 2. BOTTOM SIDE OF THE PCB IS CONTINUOUS GROUND PLANE.

- DENOTES PCB COPPER LAYOUT WITH SMOBC (SOLDER MASK OVER BARE COPPER)
- DENOTES COPPER LAND PATTERN FREE OF SOLDER MASK

Additional Detailed Technical Information	
<i>additional information is available on our dash board. To access this information click here</i>	
Performance Data	Data Table
	Swept Graphs
Case Style	MC1630 Plastic package, Terminal finish: Matte Tin Plate
Tape & Reel Standard quantities available on reel	F108 7" reels with 20, 50, 100, 200, 500, 1K or 2K devices.
Suggested Layout for PCB Design	PL-349
Evaluation Board	TB-621-12+
Environmental Ratings	ENV08T1

ESD Rating

Human Body Model (HBM): 250V, Class 1A (JESD22-A114)

Machine Model (MM): 200V, Class B (JESD22-A115)

MSL Rating

Moisture Sensitivity: MSL1 in accordance with IPC/JEDEC J-STD-020D

Notes

- A. Performance and quality attributes and conditions not expressly stated in this specification document are intended to be excluded and do not form a part of this specification document.
- B. Electrical specifications and performance data contained in this specification document are based on Mini-Circuit's applicable established test performance criteria and measurement instructions.
- C. The parts covered by this specification document are subject to Mini-Circuits standard limited warranty and terms and conditions (collectively, "Standard Terms"); Purchasers of this part are entitled to the rights and benefits contained therein. For a full statement of the Standard Terms and the exclusive rights and remedies thereunder, please visit Mini-Circuits' website at www.minicircuits.com/MCLStore/terms.jsp

