

## NPN Silicon RF Transistor

**BFQ 72**

- For low-distortion broadband amplifiers up to 2 GHz at collector currents from 10 mA to 30 mA.
- Hermetically sealed ceramic package.
- HiRel/Mil screening available.
- CECC-type available: CECC 50002/263.

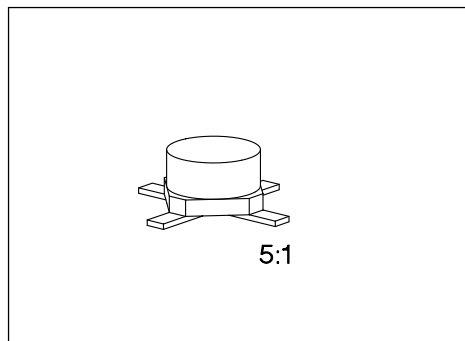

**ESD:** Electrostatic discharge sensitive device, observe handling precautions!

Type	Marking	Ordering Code (tape and reel)	Pin Configuration				Package <sup>1)</sup>
			1	2	3	4	
BFQ 72	72	Q62702-F776	B	E	C	E	Cerrec-X

### Maximum Ratings

Parameter	Symbol	Values	Unit
Collector-emitter voltage	$V_{CE0}$	15	V
Collector-emitter voltage, $V_{BE} = 0$	$V_{CES}$	20	
Collector-base voltage	$V_{CB0}$	20	
Emitter-base voltage	$V_{EB0}$	2.5	
Collector current	$I_C$	50	mA
Base current	$I_B$	10	
Total power dissipation, $T_s \leq 112 \text{ }^\circ\text{C}^3)$	$P_{tot}$	350	mW
Junction temperature	$T_j$	175	
Ambient temperature range	$T_A$	- 65 ... + 175	
Storage temperature range	$T_{stg}$	- 65 ... + 175	

### Thermal Resistance

Junction - ambient <sup>2)</sup>	$R_{th JA}$	$\leq 260$	K/W
Junction - soldering point <sup>3)</sup>	$R_{th JS}$	$\leq 180$	

1) For detailed dimensions see chapter Package Outlines.

2) Package mounted on alumina 15 mm × 16.7 mm × 0.7 mm.

3)  $T_s$  is measured on the collector lead at the soldering point to the pcb.

## Electrical Characteristics

at  $T_A = 25\text{ °C}$ , unless otherwise specified.

Parameter	Symbol	Values			Unit
		min.	typ.	max.	

## DC Characteristics

Collector-emitter breakdown voltage $I_C = 1\text{ mA}, I_B = 0$	$V_{(BR)CE0}$	15	–	–	V
Collector-emitter cutoff current $V_{CE} = 20\text{ V}, V_{BE} = 0$	$I_{CES}$	–	–	10	$\mu\text{A}$
Collector-base cutoff current $V_{CB} = 10\text{ V}, I_E = 0$	$I_{CBO}$	–	–	50	nA
Emitter-base cutoff current $V_{EB} = 2\text{ V}, I_C = 0$	$I_{EBO}$	–	–	10	$\mu\text{A}$
DC current gain $I_C = 25\text{ mA}, V_{CE} = 5\text{ V}$ $I_C = 50\text{ mA}, V_{CE} = 5\text{ V}$	$h_{FE}$	40 40	90 –	200 –	–
Collector-emitter saturation voltage $I_C = 50\text{ mA}, I_B = 5\text{ mA}$	$V_{CEsat}$	–	0.15	0.4	V
Base-emitter voltage $I_C = 25\text{ mA}, V_{CE} = 5\text{ V}$	$V_{BE}$	–	0.78	–	

## Electrical Characteristics

at  $T_A = 25\text{ }^\circ\text{C}$ , unless otherwise specified.

Parameter	Symbol	Values			Unit
		min.	typ.	max.	

## AC Characteristics

Transition frequency $I_C = 25\text{ mA}$ , $V_{CE} = 5\text{ V}$ , $f = 200\text{ MHz}$ $I_C = 50\text{ mA}$ , $V_{CE} = 5\text{ V}$ , $f = 200\text{ MHz}$	$f_t$	–	5.1 4.7	–	GHz
Collector-base capacitance $V_{CB} = 10\text{ V}$ , $V_{BE} = v_{be} = 0$ , $f = 1\text{ MHz}$	$C_{cb}$	–	0.55	0.7	pF
Collector-emitter capacitance $V_{CE} = 10\text{ V}$ , $V_{BE} = v_{be} = 0$ , $f = 1\text{ MHz}$	$C_{ce}$	–	0.4	–	
Input capacitance $V_{EB} = 0.5\text{ V}$ , $I_C = i_c = 0$ , $f = 1\text{ MHz}$	$C_{ibo}$	–	2.1	–	
Output capacitance $V_{CE} = 10\text{ V}$ , $V_{BE} = v_{be} = 0$ , $f = 1\text{ MHz}$	$C_{obs}$	–	0.95	1.5	
Noise figure $I_C = 10\text{ mA}$ , $V_{CE} = 8\text{ V}$ , $f = 10\text{ MHz}$ , $Z_S = 75\text{ }\Omega$ $I_C = 10\text{ mA}$ , $V_{CE} = 8\text{ V}$ , $f = 800\text{ MHz}$ , $Z_S = 50\text{ }\Omega$	$F$	–	1.7 2.5	–	dB
Power gain $I_C = 25\text{ mA}$ , $V_{CE} = 8\text{ V}$ , $f = 800\text{ MHz}$ , $Z_S = Z_{Sopt}$ , $Z_L = Z_{Lopt}$	$G_{pe}$	–	18	–	
Transducer gain $I_C = 25\text{ mA}$ , $V_{CE} = 8\text{ V}$ , $f = 1\text{ GHz}$ , $Z_0 = 50\text{ }\Omega$	$ S_{21e} ^2$	–	12.5	–	
Linear output voltage two-tone intermodulation test $I_C = 25\text{ mA}$ , $V_{CE} = 8\text{ V}$ , $d_{IM} = 60\text{ dB}$ $f_1 = 806\text{ MHz}$ , $f_2 = 810\text{ MHz}$ , $Z_S = Z_L = 50\text{ }\Omega$	$V_{o1} = V_{o2}$	–	240	–	mV
Third order intercept point $I_C = 25\text{ mA}$ , $V_{CE} = 8\text{ V}$ , $f = 800\text{ MHz}$	$IP_3$	–	30.5	–	dBm

### Total power dissipation $P_{tot} = f(T_A^*; T_S)$

\*Package mounted on alumina

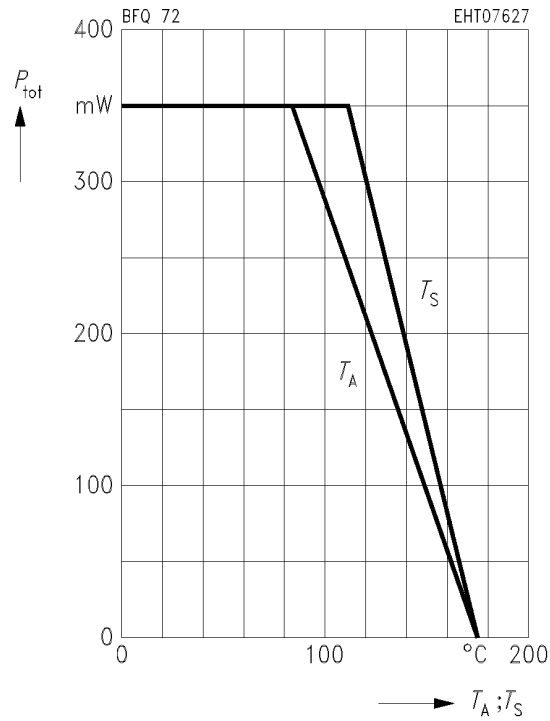

### Transition frequency $f_T = f(I_C)$

$V_{CE} = 5$  V,  $f = 200$  MHz

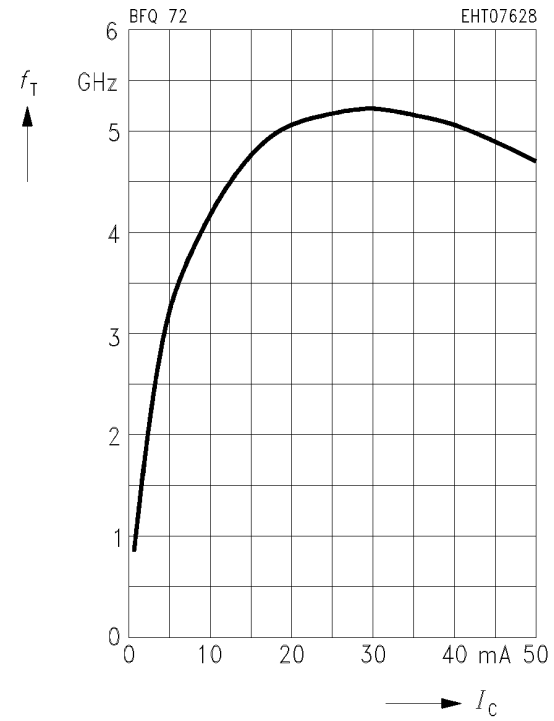

### Collector-base capacitance $C_{cb} = f(V_{CB})$

$V_{BE} = v_{be} = 0$ ,  $f = 1$  MHz

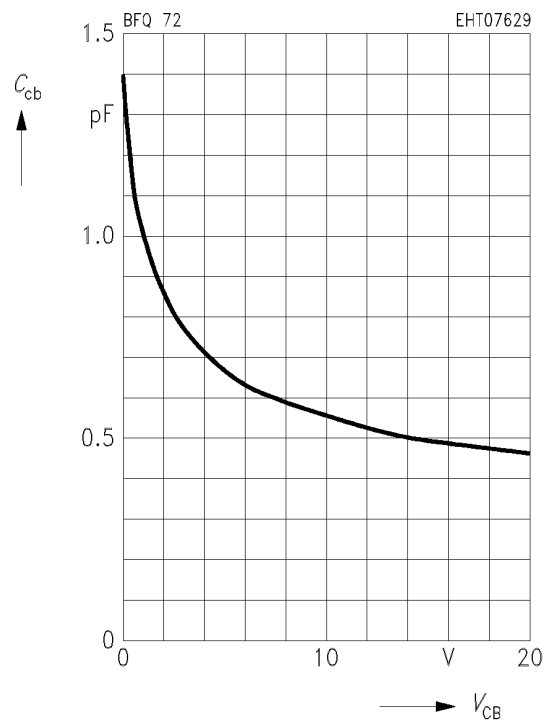

### Common Emitter Noise Parameters

$f$	$F_{min}$	$G_p(F_{min})$	$\Gamma_{opt}$		$R_N$	$N$	$F_{50 \Omega}$	$G_p(F_{50 \Omega})$
GHz	dB	dB	MAG	ANG		-	dB	dB

$I_C = 2 \text{ mA}, V_{CE} = 8 \text{ V}, Z_0 = 50 \Omega$

0.01	1.0	-	(Z <sub>s</sub> = 150 Ω)		-	-	1.6	-
------	-----	---	--------------------------	--	---	---	-----	---

$I_C = 10 \text{ mA}, V_{CE} = 8 \text{ V}, Z_0 = 50 \Omega$

0.01	1.5	-	(Z <sub>s</sub> = 90 Ω)		-	-	1.7	-
0.8	2.3	14.7	0.26	99.5	16.5	0.31	2.45	14

### Noise figure $F = f(Z_s)$

$V_{CE} = 8 \text{ V}, f = 10 \text{ MHz}$

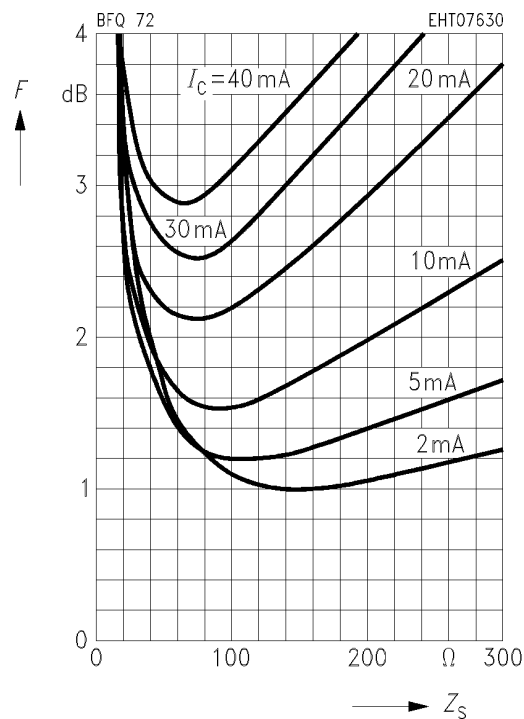

**Circles of constant noise figure  $F = f(Z_s)$**   
 in  $Z_s$ -plane,  $I_C = 10 \text{ mA}$ ,  $V_{CE} = 8 \text{ V}$ ,  
 $f = 800 \text{ MHz}$

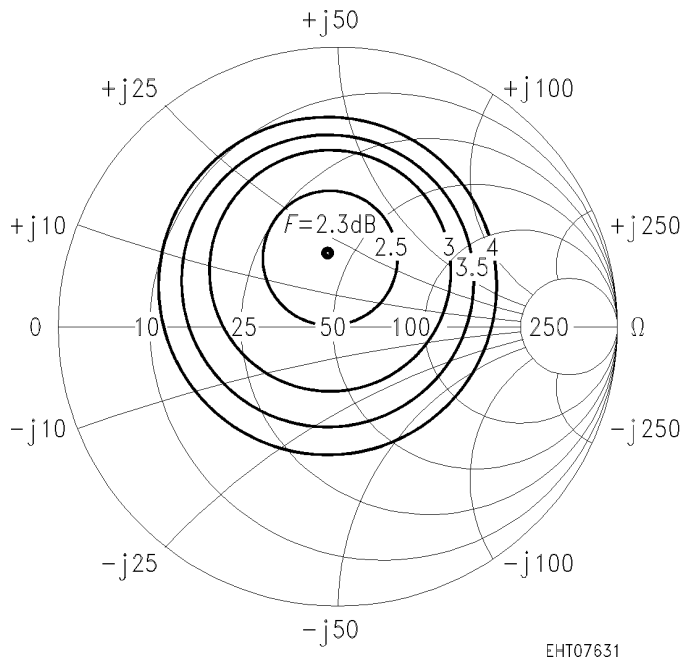

**Noise figure  $F = f(I_C)$**   
**Power gain  $G = f(I_C)$**   
 $V_{CE} = 8 \text{ V}$ ,  $f = 800 \text{ MHz}$ ,  $Z_{Lopt}(G)$

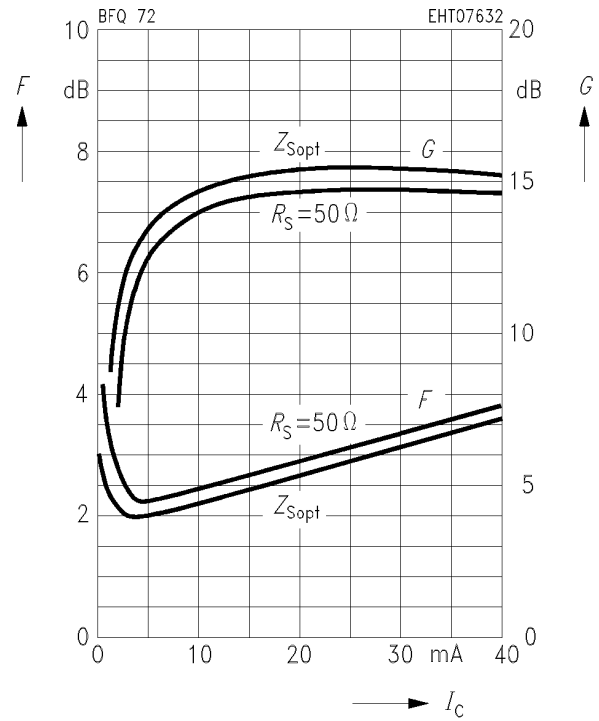

**Common Emitter Power Gain**

**Power gain  $G_{ms}$ ,  $|S_{21e}|^2 = f(I_C)$**

$V_{CE} = 8\text{ V}$ ,  $f = 200\text{ MHz}$ ,  $Z_0 = 50\ \Omega$

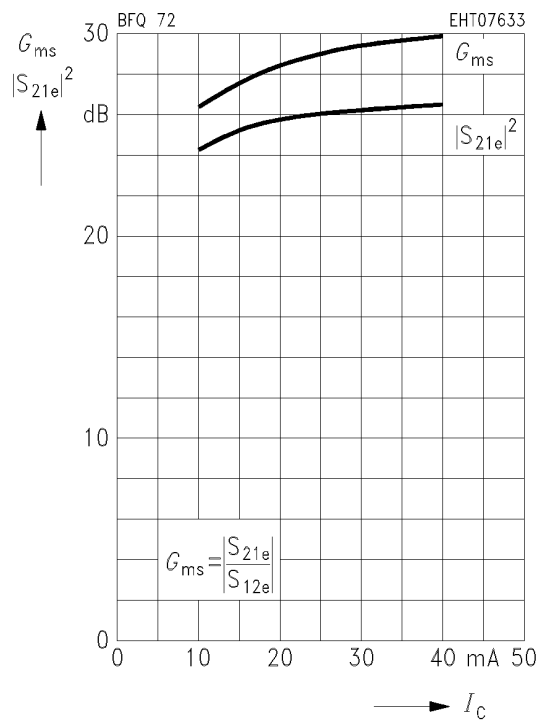

**Power gain  $G_{ma}$ ,  $G_{ms}$ ,  $|S_{21e}|^2 = f(I_C)$**

$V_{CE} = 8\text{ V}$ ,  $f = 500\text{ MHz}$ ,  $Z_0 = 50\ \Omega$

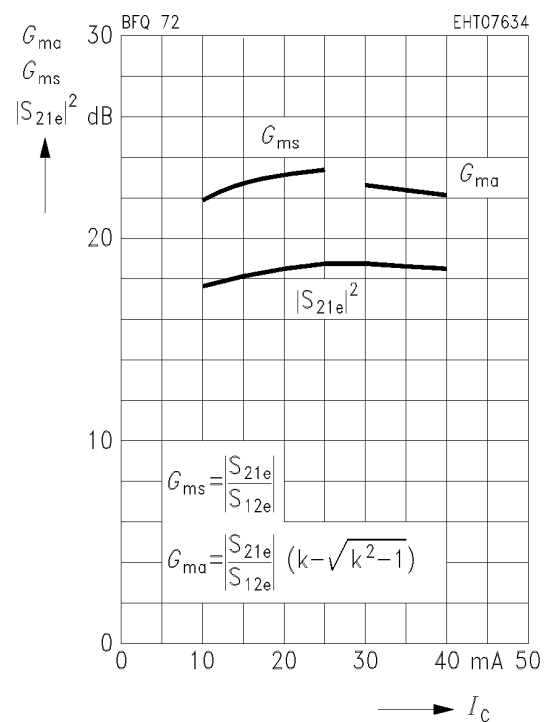

**Power gain  $G_{ma}$ ,  $|S_{21e}|^2 = f(I_C)$**

$V_{CE} = 8\text{ V}$ ,  $f = 800\text{ MHz}$ ,  $Z_0 = 50\ \Omega$

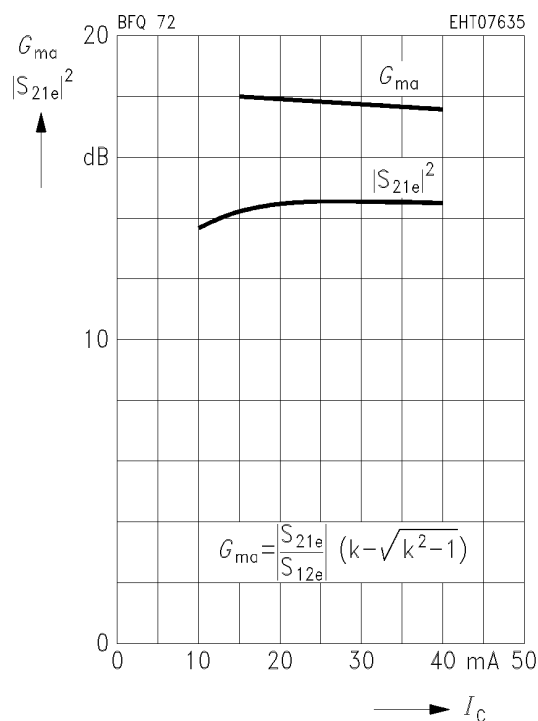

**Power gain  $G_{ma}$ ,  $|S_{21e}|^2 = f(I_C)$**

$V_{CE} = 8\text{ V}$ ,  $f = 1.5\text{ GHz}$ ,  $Z_0 = 50\ \Omega$

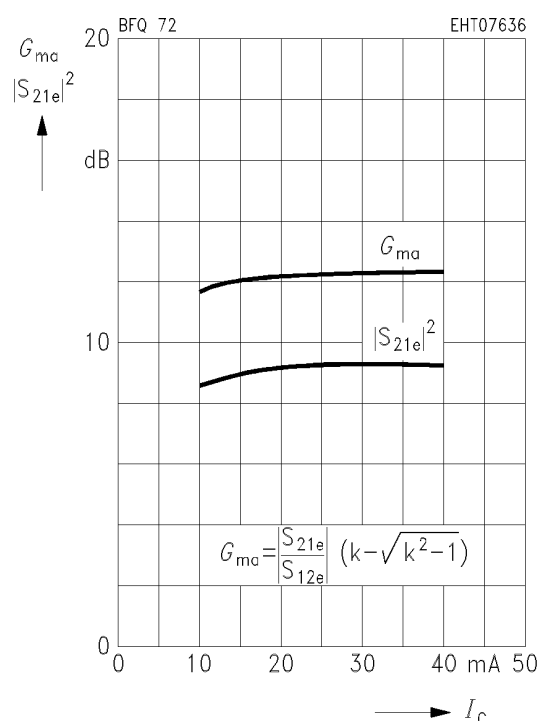

### Power gain $G_{ma}, G_{ms}, |S_{21e}|^2 = f(f)$

$I_C = 10 \text{ mA}, V_{CE} = 8 \text{ V}, Z_0 = 50 \Omega$

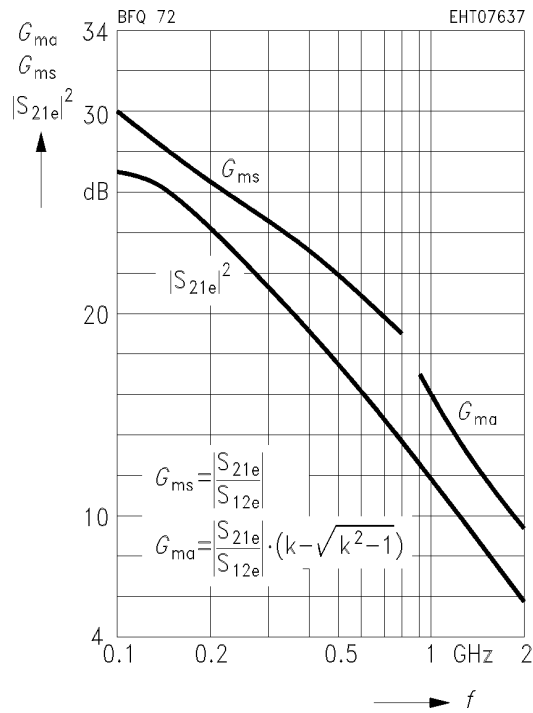

### Power gain $G_{ma}, G_{ms}, |S_{21e}|^2 = f(f)$

$I_C = 25 \text{ mA}, V_{CE} = 8 \text{ V}, Z_0 = 50 \Omega$

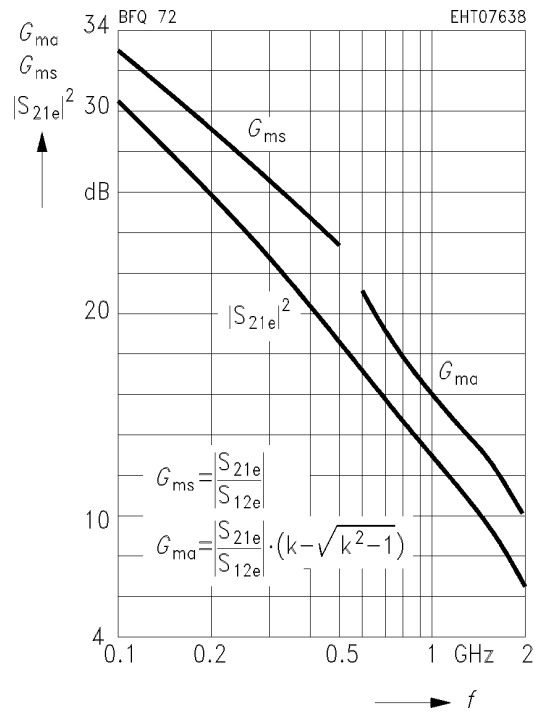

### Power gain $G_{ma}, G_{ms}, |S_{21e}|^2 = f(f)$

$I_C = 40 \text{ mA}, V_{CE} = 8 \text{ V}, Z_0 = 50 \Omega$

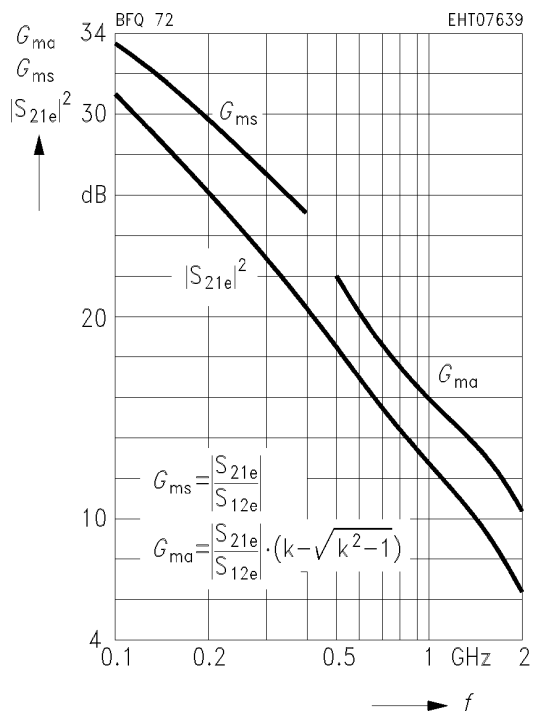



## Common Emitter S Parameters

<i>f</i>	<i>S</i> <sub>11</sub>		<i>S</i> <sub>21</sub>		<i>S</i> <sub>12</sub>		<i>S</i> <sub>22</sub>	
	MAG	ANG	MAG	ANG	MAG	ANG	MAG	ANG

*I*<sub>C</sub> = 15 mA, *V*<sub>CE</sub> = 5 V, *Z*<sub>0</sub> = 50 Ω

0.1	0.62	- 78	26.97	137	0.023	59	0.76	- 34
0.2	0.57	- 121	17.54	114	0.032	47	0.51	- 50
0.3	0.56	- 142	12.39	102	0.039	44	0.38	- 55
0.4	0.57	- 155	9.59	94	0.043	45	0.31	- 56
0.6	0.57	- 169	6.47	84	0.053	48	0.24	- 57
0.8	0.58	- 179	4.86	76	0.064	50	0.21	- 59
1.0	0.58	174	3.89	69	0.075	50	0.19	- 60
1.2	0.59	167	3.28	63	0.086	50	0.18	- 63
1.5	0.59	159	2.64	54	0.102	48	0.17	- 67
1.8	0.61	153	2.20	46	0.119	46	0.17	- 75
2.0	0.63	149	1.99	41	0.128	44	0.17	- 82
2.5	0.64	138	1.63	28	0.153	40	0.17	- 100
3.0	0.67	128	1.38	16	0.177	34	0.19	- 119

*S*<sub>11</sub>, *S*<sub>22</sub> = *f* (*f*)

*I*<sub>C</sub> = 15 mA, *V*<sub>CE</sub> = 5 V, *Z*<sub>0</sub> = 50 Ω

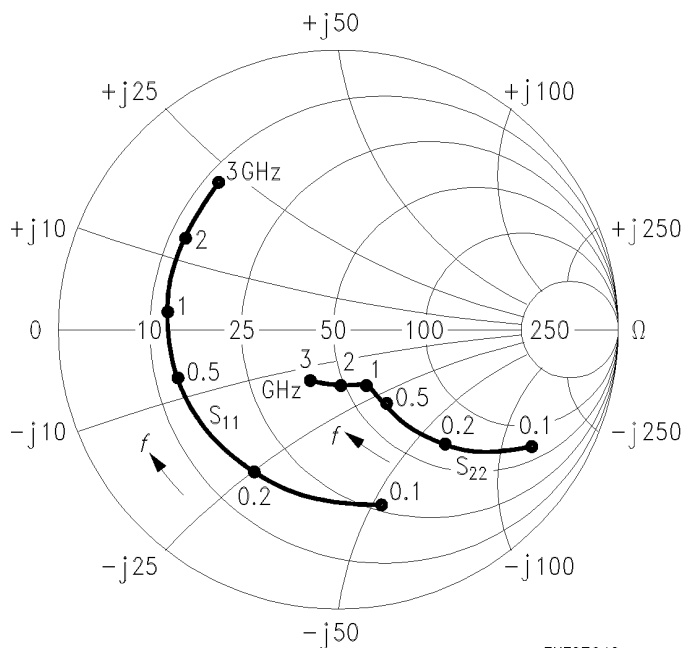

EHT07640

*S*<sub>12</sub>, *S*<sub>21</sub> = *f* (*f*)

*I*<sub>C</sub> = 15 mA, *V*<sub>CE</sub> = 5 V, *Z*<sub>0</sub> = 50 Ω

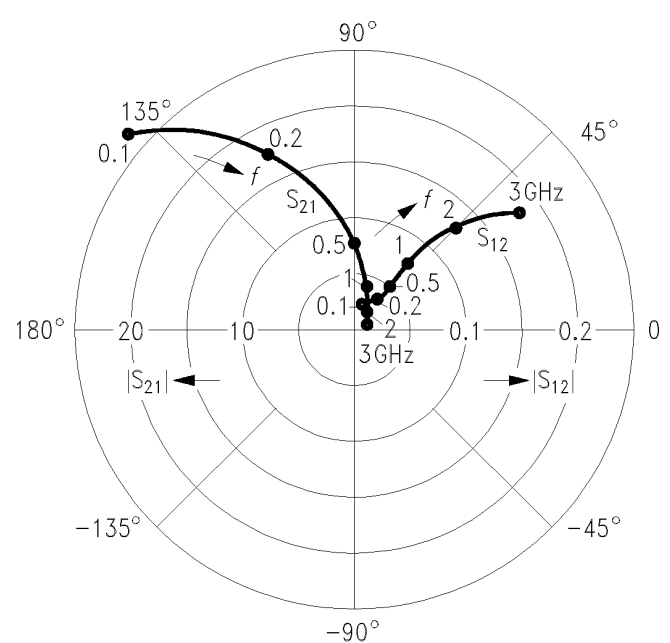

EHT07641

### Common Emitter S Parameters (continued)

<i>f</i>	<i>S</i> <sub>11</sub>		<i>S</i> <sub>21</sub>		<i>S</i> <sub>12</sub>		<i>S</i> <sub>22</sub>		
	GHz	MAG	ANG	MAG	ANG	MAG	ANG	MAG	ANG
<i>I</i> <sub>C</sub> = 25 mA, <i>V</i> <sub>CE</sub> = 5 V, <i>Z</i> <sub>0</sub> = 50 Ω									
0.1	0.54	- 99	31.95	130	0.018	57	0.66	- 41	
0.2	0.55	- 137	19.18	108	0.027	48	0.42	- 55	
0.3	0.55	- 154	13.20	98	0.032	49	0.30	- 59	
0.4	0.57	- 164	10.09	91	0.037	52	0.24	- 60	
0.6	0.57	- 176	6.76	82	0.049	55	0.19	- 60	
0.8	0.58	176	5.06	74	0.061	56	0.17	- 61	
1.0	0.59	170	4.04	68	0.072	55	0.15	- 63	
1.2	0.60	165	3.40	62	0.084	55	0.14	- 66	
1.5	0.60	157	2.74	54	0.101	52	0.14	- 70	
1.8	0.61	151	2.28	46	0.118	49	0.14	- 79	
2.0	0.63	147	2.06	41	0.127	47	0.14	- 87	
2.5	0.65	137	1.68	29	0.153	42	0.14	- 106	
3.0	0.68	127	1.42	17	0.177	36	0.17	- 126	

*S*<sub>11</sub>, *S*<sub>22</sub> = *f* (*f*)

*I*<sub>C</sub> = 25 mA, *V*<sub>CE</sub> = 5 V, *Z*<sub>0</sub> = 50 Ω

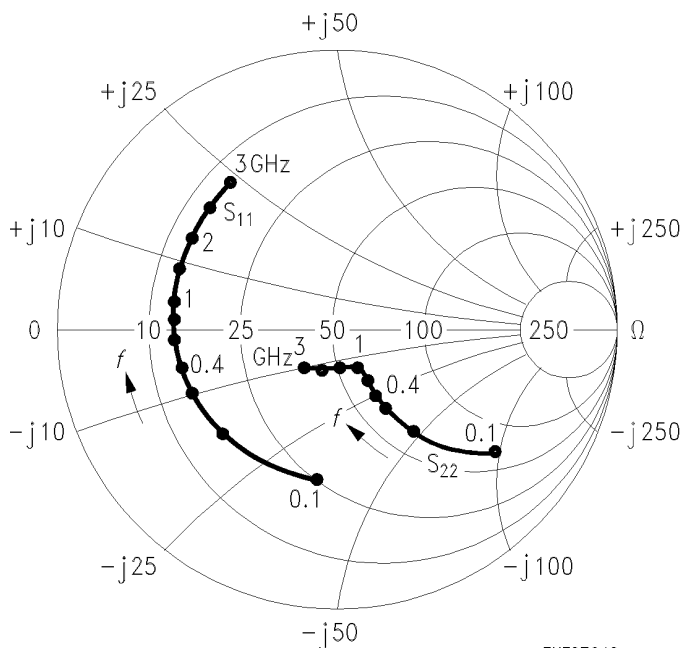

EHT07642

*S*<sub>12</sub>, *S*<sub>21</sub> = *f* (*f*)

*I*<sub>C</sub> = 25 mA, *V*<sub>CE</sub> = 5 V, *Z*<sub>0</sub> = 50 Ω

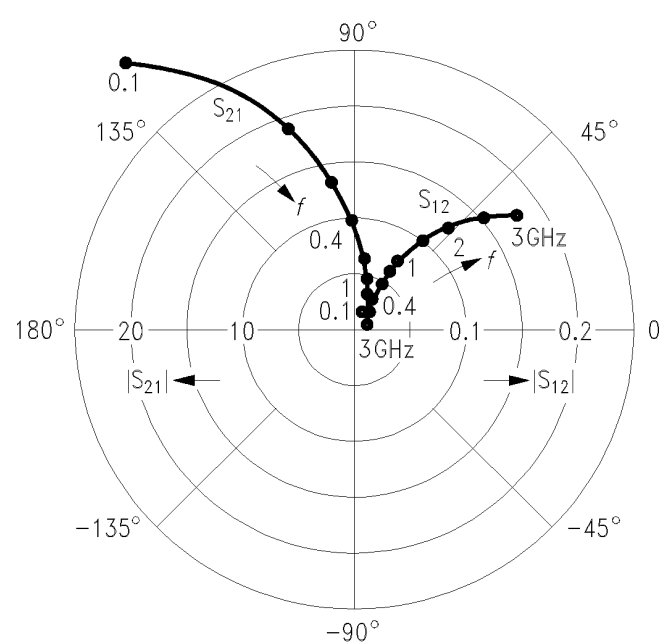

EHT07643

### Common Emitter S Parameters (continued)

<i>f</i>	<i>S</i> <sub>11</sub>		<i>S</i> <sub>21</sub>		<i>S</i> <sub>12</sub>		<i>S</i> <sub>22</sub>	
	MAG	ANG	MAG	ANG	MAG	ANG	MAG	ANG
0.1	0.51	-126	34.20	121	0.014	54	0.55	-46
0.2	0.55	-154	18.99	103	0.021	53	0.33	-52
0.3	0.55	-166	12.81	94	0.026	57	0.25	-52
0.4	0.58	-173	9.72	88	0.032	59	0.21	-51
0.6	0.59	178	6.47	80	0.045	62	0.18	-50
0.8	0.60	172	4.84	73	0.057	61	0.17	-52
1.0	0.61	167	3.86	67	0.069	60	0.16	-55
1.2	0.62	162	3.25	62	0.080	59	0.15	-59
1.5	0.62	155	2.62	53	0.097	56	0.15	-65
1.8	0.64	149	2.18	45	0.114	53	0.15	-74
2.0	0.66	145	1.97	41	0.123	51	0.15	-83
2.5	0.67	136	1.61	29	0.149	46	0.15	-104
3.0	0.70	126	1.37	18	0.174	40	0.17	-125

$I_C = 50 \text{ mA}, V_{CE} = 5 \text{ V}, Z_0 = 50 \Omega$

### $S_{11}, S_{22} = f(f)$

$I_C = 50 \text{ mA}, V_{CE} = 5 \text{ V}, Z_0 = 50 \Omega$

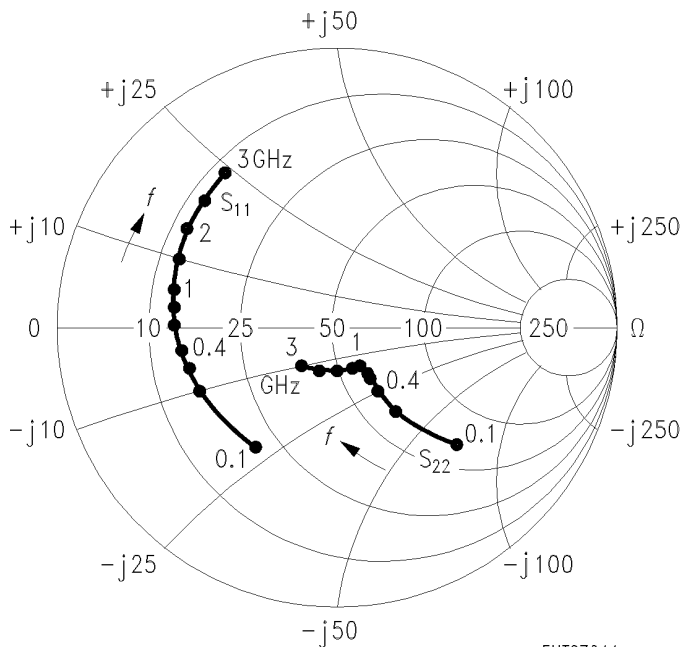

EHT07644

### $S_{12}, S_{21} = f(f)$

$I_C = 50 \text{ mA}, V_{CE} = 5 \text{ V}, Z_0 = 50 \Omega$

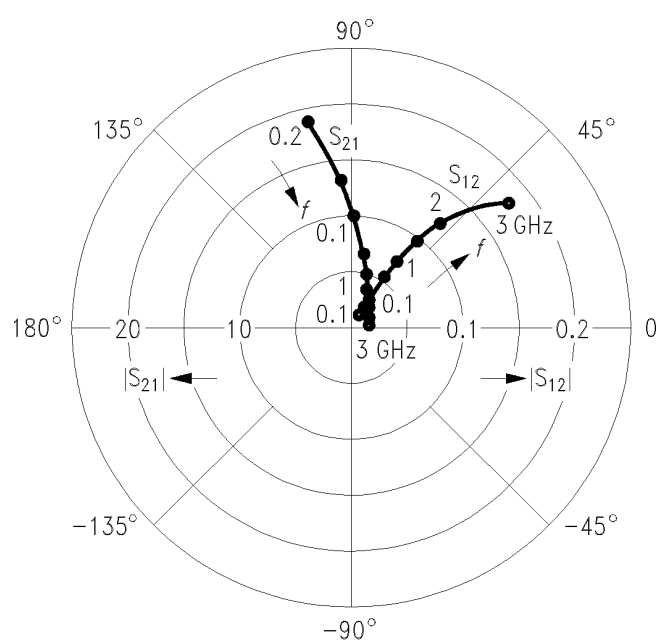

EHT07645

### Common Emitter S Parameters (continued)

<i>f</i>	<i>S</i> <sub>11</sub>		<i>S</i> <sub>21</sub>		<i>S</i> <sub>12</sub>		<i>S</i> <sub>22</sub>	
	MAG	ANG	MAG	ANG	MAG	ANG	MAG	ANG
0.1	0.69	- 59	22.59	145	0.023	63	0.85	- 24
0.2	0.61	- 100	16.18	121	0.036	49	0.64	- 37
0.3	0.57	- 124	11.90	108	0.042	44	0.51	- 41
0.4	0.56	- 140	9.39	99	0.046	43	0.43	- 43
0.6	0.55	- 159	6.42	87	0.055	44	0.36	- 43
0.8	0.55	- 171	4.86	78	0.064	45	0.33	- 44
1.0	0.56	- 179	3.90	71	0.073	46	0.31	- 46
1.2	0.56	173	3.29	65	0.082	46	0.30	- 48
1.5	0.57	164	2.66	55	0.096	45	0.29	- 52
1.8	0.58	157	2.21	46	0.110	44	0.29	- 59
2.0	0.60	152	2.00	41	0.119	42	0.28	- 64
2.5	0.62	141	1.64	28	0.141	39	0.28	- 78
3.0	0.65	131	1.39	17	0.162	35	0.28	- 95

*I*<sub>C</sub> = 10 mA, *V*<sub>CE</sub> = 8 V, *Z*<sub>0</sub> = 50 Ω

### *S*<sub>11</sub>, *S*<sub>22</sub> = *f* (*f*)

*I*<sub>C</sub> = 10 mA, *V*<sub>CE</sub> = 8 V, *Z*<sub>0</sub> = 50 Ω

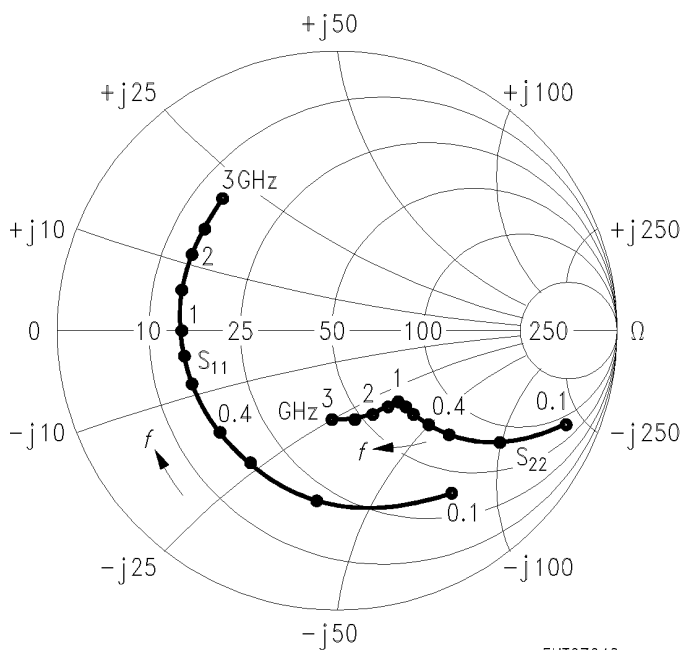

EHT07646

### *S*<sub>12</sub>, *S*<sub>21</sub> = *f* (*f*)

*I*<sub>C</sub> = 10 mA, *V*<sub>CE</sub> = 8 V, *Z*<sub>0</sub> = 50 Ω

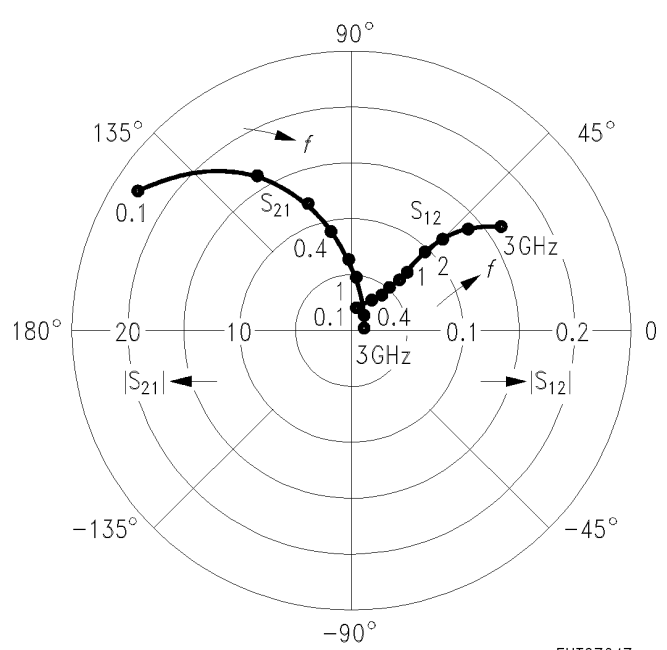

EHT07647

### Common Emitter S Parameters (continued)

<i>f</i>	<i>S</i> <sub>11</sub>		<i>S</i> <sub>21</sub>		<i>S</i> <sub>12</sub>		<i>S</i> <sub>22</sub>	
	MAG	ANG	MAG	ANG	MAG	ANG	MAG	ANG
0.1	0.55	- 90	32.99	132	0.017	56	0.71	- 35
0.2	0.53	- 131	20.17	110	0.024	50	0.46	- 44
0.3	0.52	- 150	13.96	99	0.030	50	0.36	- 45
0.4	0.54	- 160	10.71	92	0.035	53	0.30	- 44
0.6	0.54	- 172	7.17	83	0.046	56	0.26	- 43
0.8	0.55	179	5.38	75	0.057	57	0.24	- 43
1.0	0.56	172	4.29	69	0.067	56	0.23	- 45
1.2	0.56	167	3.62	63	0.078	55	0.22	- 47
1.5	0.57	159	2.91	54	0.094	53	0.22	- 51
1.8	0.59	153	2.42	47	0.109	50	0.22	- 59
2.0	0.61	149	2.18	42	0.119	48	0.21	- 65
2.5	0.62	139	1.78	30	0.142	44	0.21	- 80
3.0	0.66	129	1.51	18	0.165	39	0.22	- 98

$I_C = 25 \text{ mA}, V_{CE} = 8 \text{ V}, Z_0 = 50 \Omega$

$S_{11}, S_{22} = f(f)$

$I_C = 25 \text{ mA}, V_{CE} = 8 \text{ V}, Z_0 = 50 \Omega$

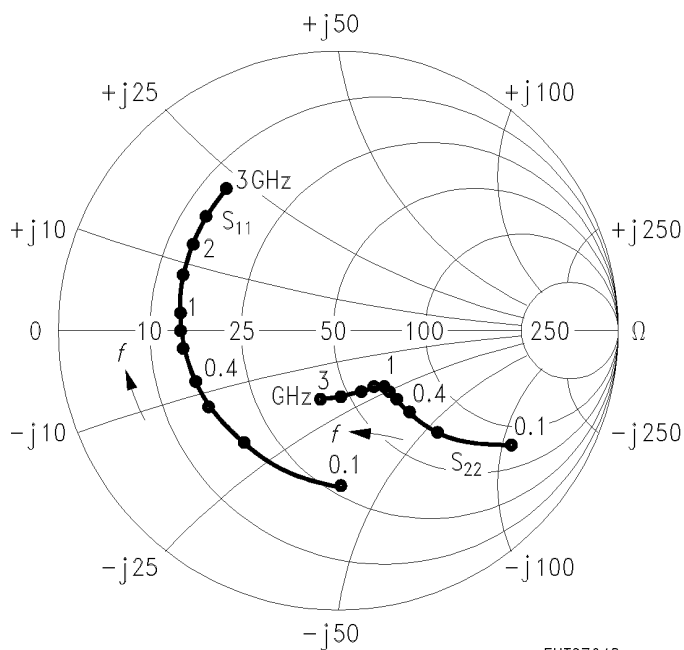

EHT07648

$S_{12}, S_{21} = f(f)$

$I_C = 25 \text{ mA}, V_{CE} = 8 \text{ V}, Z_0 = 50 \Omega$

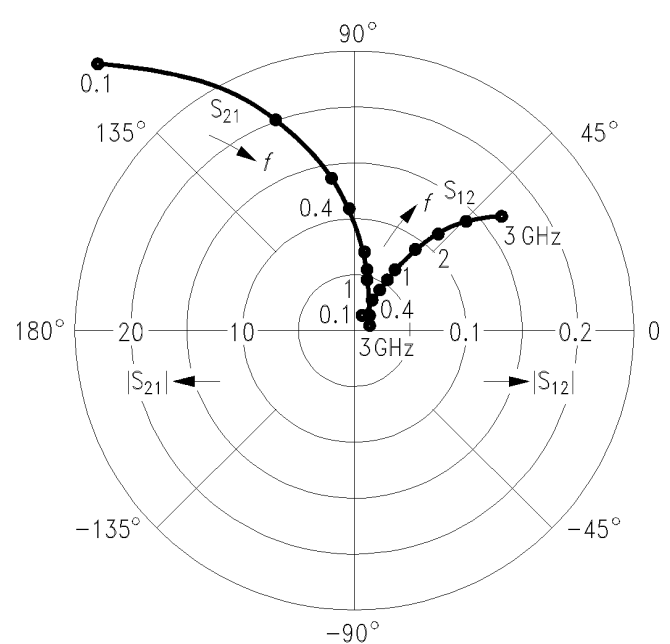

EHT07649

### Common Emitter S Parameters (continued)

<i>f</i>	<i>S</i> <sub>11</sub>		<i>S</i> <sub>21</sub>		<i>S</i> <sub>12</sub>		<i>S</i> <sub>22</sub>	
	MAG	ANG	MAG	ANG	MAG	ANG	MAG	ANG
0.1	0.51	-108	35.70	126	0.016	57	0.64	-37
0.2	0.52	-144	20.53	105	0.021	52	0.41	-42
0.3	0.53	-159	13.96	96	0.027	55	0.32	-41
0.4	0.54	-167	10.64	90	0.032	57	0.28	-39
0.6	0.55	-177	7.10	81	0.043	60	0.25	-38
0.8	0.56	176	5.32	74	0.054	60	0.24	-39
1.0	0.57	170	4.24	68	0.066	59	0.23	-41
1.2	0.58	165	3.57	63	0.076	58	0.22	-44
1.5	0.59	157	2.87	54	0.092	56	0.22	-49
1.8	0.60	152	2.39	46	0.107	52	0.22	-57
2.0	0.62	148	2.16	42	0.116	51	0.21	-63
2.5	0.64	138	1.77	29	0.140	46	0.21	-79
3.0	0.67	128	1.50	18	0.163	41	0.22	-98

*I*<sub>C</sub> = 40 mA, *V*<sub>CE</sub> = 8 V, *Z*<sub>0</sub> = 50 Ω

*S*<sub>11</sub>, *S*<sub>22</sub> = *f*(*f*)

*I*<sub>C</sub> = 40 mA, *V*<sub>CE</sub> = 8 V, *Z*<sub>0</sub> = 50 Ω

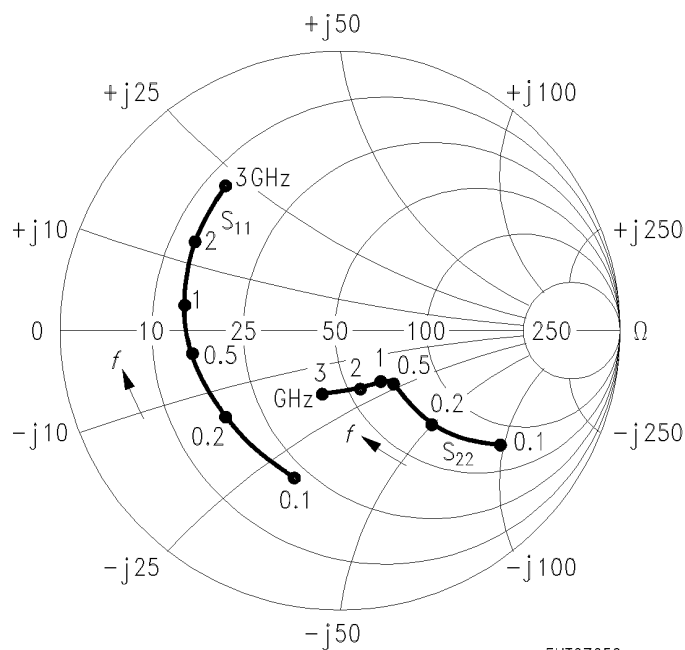

EHT07650

*S*<sub>12</sub>, *S*<sub>21</sub> = *f*(*f*)

*I*<sub>C</sub> = 40 mA, *V*<sub>CE</sub> = 8 V, *Z*<sub>0</sub> = 50 Ω

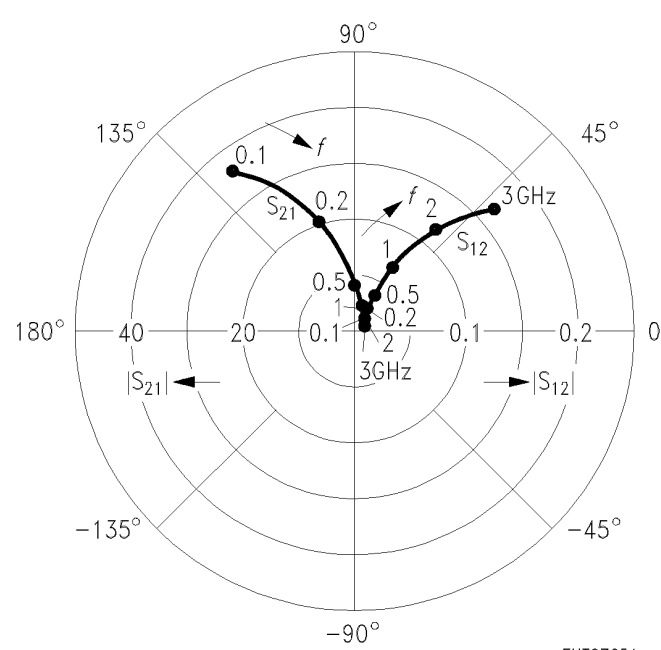

EHT07651