

# DATA SHEET

**BFG97**

**NPN 5 GHz wideband transistor**

Product specification  
File under Discrete Semiconductors, SC14

September 1995

## NPN 5 GHz wideband transistor

BFG97

## DESCRIPTION

NPN planar epitaxial transistor mounted in a plastic SOT223 envelope. It features excellent output voltage capabilities, and is primarily intended for use in MATV applications.

PNP complement is the BFG31.

## PINNING

PIN	DESCRIPTION
1	emitter
2	base
3	emitter
4	collector

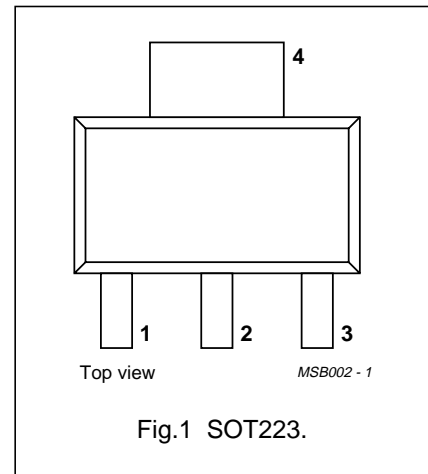

## QUICK REFERENCE DATA

SYMBOL	PARAMETER	CONDITIONS	MIN.	TYP.	MAX.	UNIT
$V_{CBO}$	collector-base voltage	open emitter	–	–	20	V
$V_{CEO}$	collector-emitter voltage	open base	–	–	15	V
$I_C$	DC collector current		–	–	100	mA
$P_{tot}$	total power dissipation	up to $T_s = 125\text{ °C}$ (note 1)	–	–	1	W
$h_{FE}$	DC current gain	$I_C = 70\text{ mA}$ ; $V_{CE} = 10\text{ V}$ ; $T_j = 25\text{ °C}$	25	80	–	
$f_T$	transition frequency	$I_C = 70\text{ mA}$ ; $V_{CE} = 10\text{ V}$ ; $f = 500\text{ MHz}$ ; $T_{amb} = 25\text{ °C}$	–	5.5	–	GHz
$G_{UM}$	maximum unilateral power gain	$I_C = 70\text{ mA}$ ; $V_{CE} = 10\text{ V}$ ; $f = 500\text{ MHz}$ ; $T_{amb} = 25\text{ °C}$	–	16	–	dB
		$I_C = 70\text{ mA}$ ; $V_{CE} = 10\text{ V}$ ; $f = 800\text{ MHz}$ ; $T_{amb} = 25\text{ °C}$	–	12	–	dB
$V_o$	output voltage	$I_C = 70\text{ mA}$ ; $V_{CE} = 10\text{ V}$ ; $d_{im} = -60\text{ dB}$ ; $R_L = 75\text{ }\Omega$ ; $f_{(p+q-r)} = 793.25\text{ MHz}$ ; $T_{amb} = 25\text{ °C}$	–	700	–	mV

## LIMITING VALUES

In accordance with the Absolute Maximum System (IEC 134).

SYMBOL	PARAMETER	CONDITIONS	MIN.	MAX.	UNIT
$V_{CBO}$	collector-base voltage	open emitter	–	20	V
$V_{CEO}$	collector-emitter voltage	open base	–	15	V
$V_{EBO}$	emitter-base voltage	open collector	–	3	V
$I_C$	DC collector current		–	100	mA
$P_{tot}$	total power dissipation	up to $T_s = 125\text{ °C}$ (note 1)	–	1	W
$T_{stg}$	storage temperature		–65	150	°C
$T_j$	junction temperature		–	175	°C

## Note

- $T_s$  is the temperature at the soldering point of the collector tab.

## NPN 5 GHz wideband transistor

BFG97

## THERMAL RESISTANCE

SYMBOL	PARAMETER	CONDITIONS	THERMAL RESISTANCE
$R_{th\ j-s}$	thermal resistance from junction to soldering point	up to $T_s = 125\text{ °C}$ (note 1)	50 K/W

## Note

- $T_s$  is the temperature at the soldering point of the collector tab.

## CHARACTERISTICS

$T_j = 25\text{ °C}$  unless otherwise specified.

SYMBOL	PARAMETER	CONDITIONS	MIN.	TYP.	MAX.	UNIT
$I_{CBO}$	collector cut-off current	$I_E = 0; V_{CB} = 10\text{ V}$	–	–	100	nA
$h_{FE}$	DC current gain	$I_C = 70\text{ mA}; V_{CE} = 10\text{ V}$	25	80	–	
$f_T$	transition frequency	$I_C = 70\text{ mA}; V_{CE} = 10\text{ V};$ $f = 500\text{ MHz}; T_{amb} = 25\text{ °C}$	–	5.5	–	GHz
$C_c$	collector capacitance	$I_E = i_e = 0; V_{CB} = 10\text{ V}; f = 1\text{ MHz}$	–	1.5	–	pF
$C_e$	emitter capacitance	$I_C = i_c = 0; V_{EB} = 0.5\text{ V}; f = 1\text{ MHz}$	–	6.5	–	pF
$C_{re}$	feedback capacitance	$I_C = 0; V_{CE} = 10\text{ V}; f = 1\text{ MHz}$	–	1	–	pF
$G_{UM}$	maximum unilateral power gain (note 1)	$I_C = 70\text{ mA}; V_{CE} = 10\text{ V};$ $f = 500\text{ MHz}; T_{amb} = 25\text{ °C}$	–	16	–	dB
		$I_C = 70\text{ mA}; V_{CE} = 10\text{ V};$ $f = 800\text{ MHz}; T_{amb} = 25\text{ °C}$	–	12	–	dB
$V_o$	output voltage	note 2	–	750	–	mV
		note 3	–	700	–	mV
$d_2$	second order intermodulation distortion	note 4	–	–56	–	dB
		note 5	–	–53	–	dB

## Notes

- $G_{UM}$  is the maximum unilateral power gain, assuming  $S_{12}$  is zero and

$$G_{UM} = 10 \log \left( \frac{|S_{21}|^2}{(1 - |S_{11}|^2)(1 - |S_{22}|^2)} \right) \text{ dB.}$$

- $d_{im} = -60\text{ dB}$  (DIN 45004B);  $I_C = 70\text{ mA}; V_{CE} = 10\text{ V}; R_L = 75\text{ }\Omega; T_{amb} = 25\text{ °C}$   
 $V_p = V_o$  at  $d_{im} = -60\text{ dB}$ ;  
 $V_q = V_o - 6\text{ dB}; f_p = 445.25\text{ MHz};$   
 $V_r = V_o - 6\text{ dB}; f_q = 453.25\text{ MHz}; f_r = 455.25\text{ MHz};$   
measured at  $f_{(p+q-r)} = 443.25\text{ MHz}$ .
- $d_{im} = -60\text{ dB}$  (DIN 45004B);  $I_C = 70\text{ mA}; V_{CE} = 10\text{ V}; R_L = 75\text{ }\Omega; T_{amb} = 25\text{ °C}$   
 $V_p = V_o$  at  $d_{im} = -60\text{ dB}$ ;  
 $V_q = V_o - 6\text{ dB}; f_p = 795.25\text{ MHz};$   
 $V_r = V_o - 6\text{ dB}; f_q = 803.25\text{ MHz}; f_r = 805.25\text{ MHz};$   
measured at  $f_{(p+q-r)} = 793.25\text{ MHz}$ .
- $I_C = 70\text{ mA}; V_{CE} = 10\text{ V}; R_L = 75\text{ }\Omega; T_{amb} = 25\text{ °C};$   
 $V_p = V_q = V_o = 50\text{ dBmV}; f_{(p+q)} = 450\text{ MHz}; f_p = 50\text{ MHz}; f_q = 400\text{ MHz}.$
- $I_C = 70\text{ mA}; V_{CE} = 10\text{ V}; R_L = 75\text{ }\Omega; T_{amb} = 25\text{ °C};$   
 $V_p = V_q = V_o = 50\text{ dBmV}; f_{(p+q)} = 810\text{ MHz}; f_p = 250\text{ MHz}; f_q = 560\text{ MHz}.$

NPN 5 GHz wideband transistor

BFG97

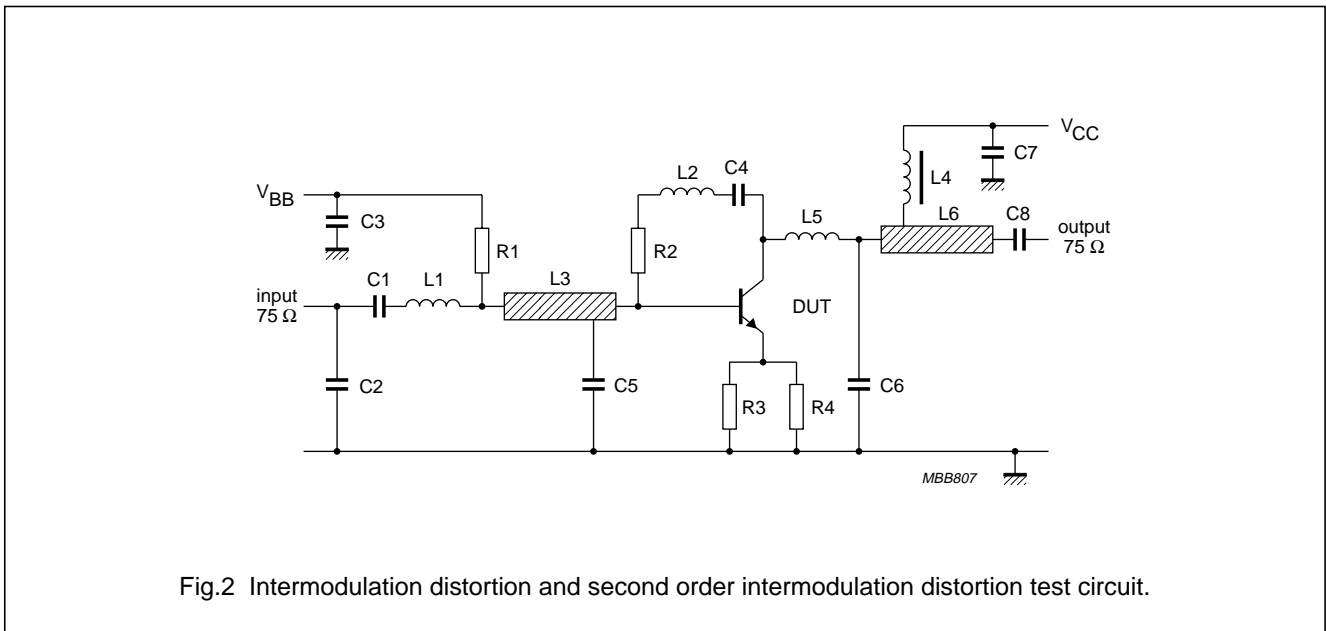

Fig.2 Intermodulation distortion and second order intermodulation distortion test circuit.

List of components (see test circuit)

DESIGNATION	DESCRIPTION	VALUE	DIMENSIONS	CATALOGUE NO.
C2, C3, C7, C8	multilayer ceramic capacitor	10 nF		2222 590 08627
C1, C4, C6	multilayer ceramic capacitor	1.2 pF		2222 851 12128
C5 (note 1)	miniature ceramic plate capacitor	10 nF		2222 629 08103
L1 (note 1)	0.5 turns 0.4 mm copper wire		int. dia. 3 mm	
L2	microstripline	75 Ω	length 14 mm; width 2.5 mm	
L3	microstripline	75 Ω	length 8 mm; width 2.5 mm	
L4, L5 (note 1)	1.5 turns 0.4 mm copper wire		int. dia. 3 mm; winding pitch 1 mm	
L6	microstripline	75 Ω	length 19 mm; width 2.5 mm	
L7	Ferroxcube choke	5 μH		3122 108 20153
R1	metal film resistor	10 kΩ		2322 180 73103
R2 (note 1)	metal film resistor	220 Ω		2322 180 73221
R3, R4	metal film resistor	30 Ω		2322 180 73309

Notes

The circuit has been built on a double copper-clad printed circuit board with PTFE dielectric ( $\epsilon_r = 2.2$ ); thickness  $1/16$  inch; thickness of copper sheet  $2 \times 35 \mu\text{m}$ .

- Components C5, L1, L4, L5, and R2 are mounted on the underside of the PCB.

NPN 5 GHz wideband transistor

BFG97

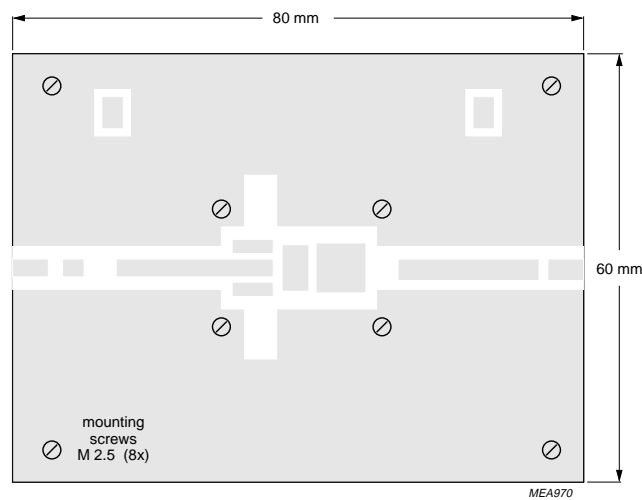
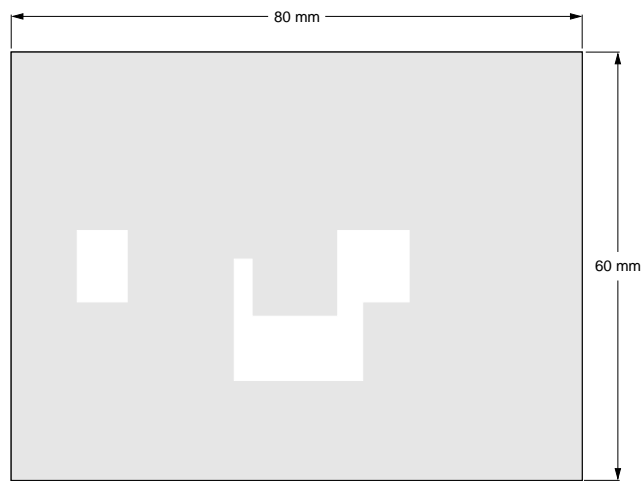
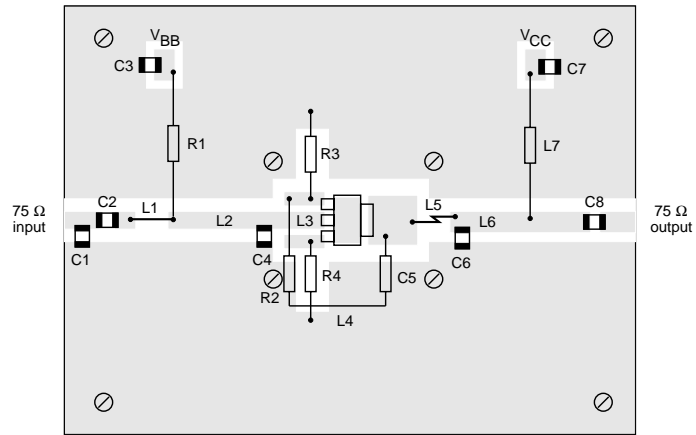
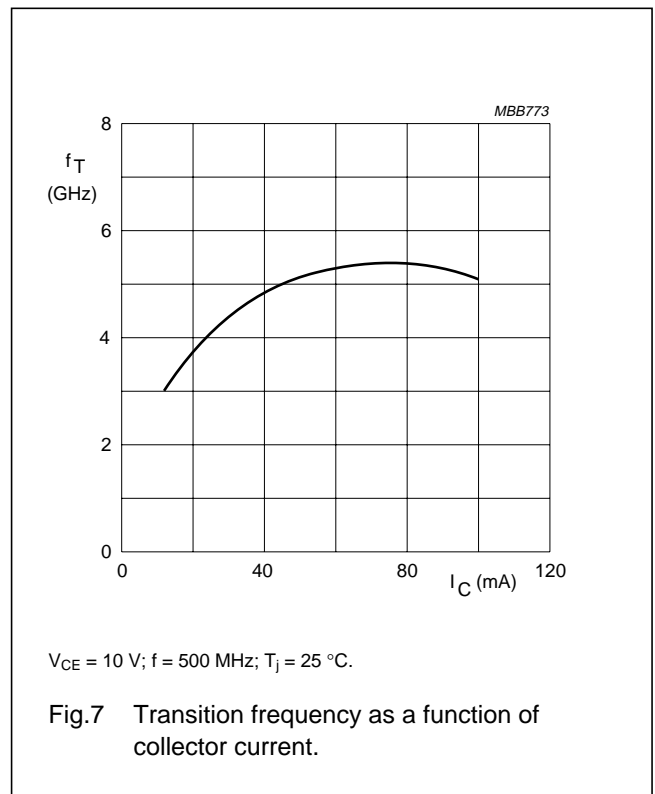
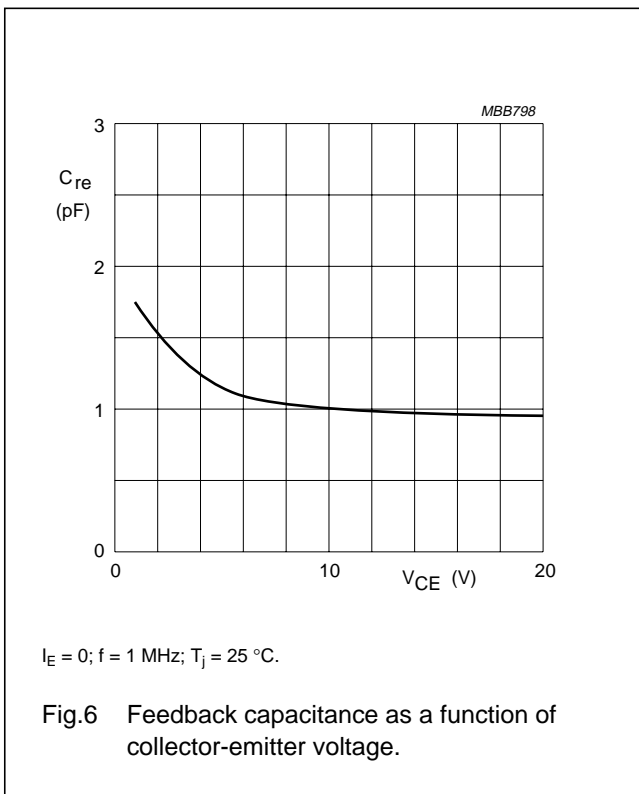
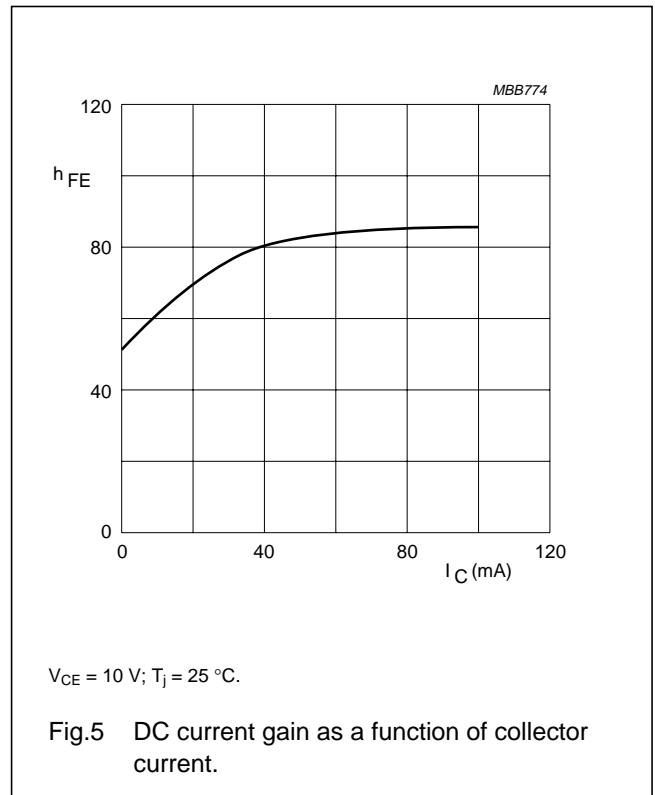
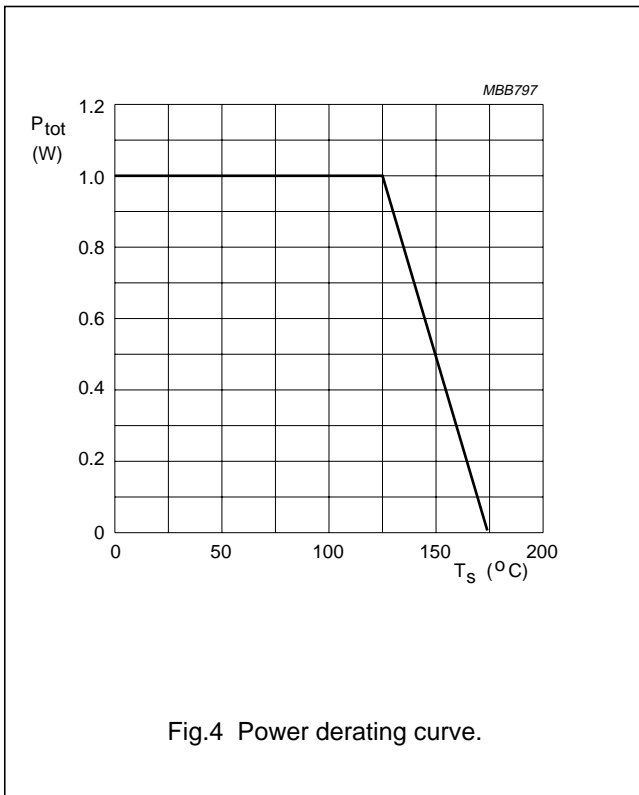

Fig.3 Intermodulation distortion and second order intermodulation distortion printed circuit board.

NPN 5 GHz wideband transistor

BFG97



NPN 5 GHz wideband transistor

BFG97

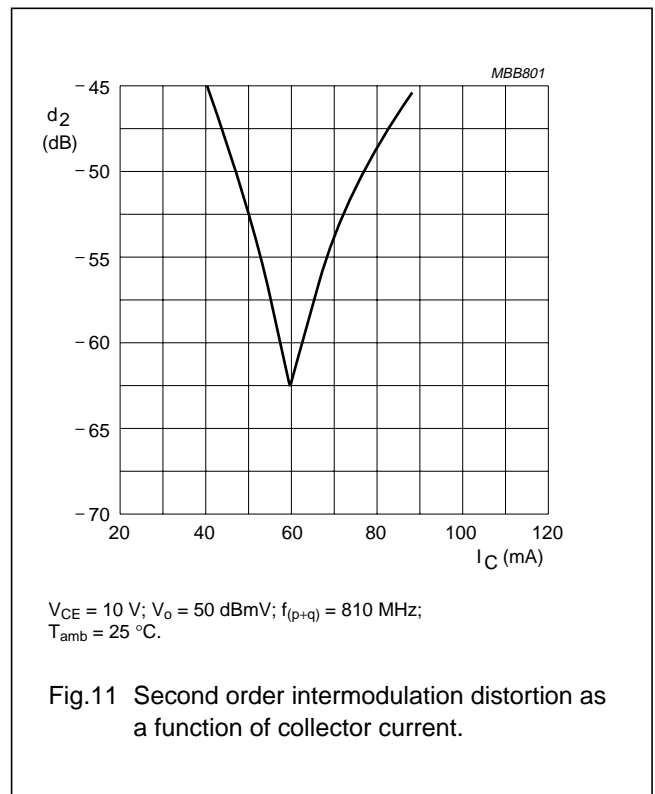
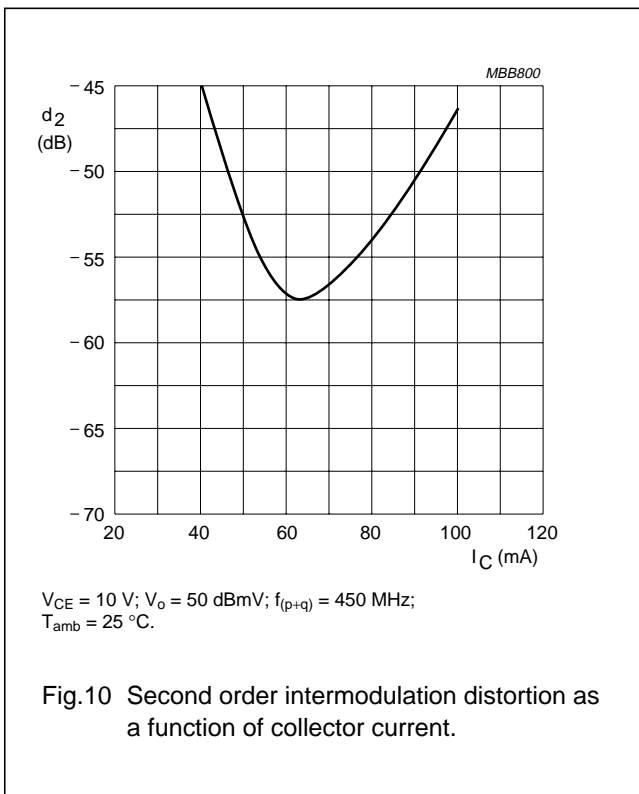
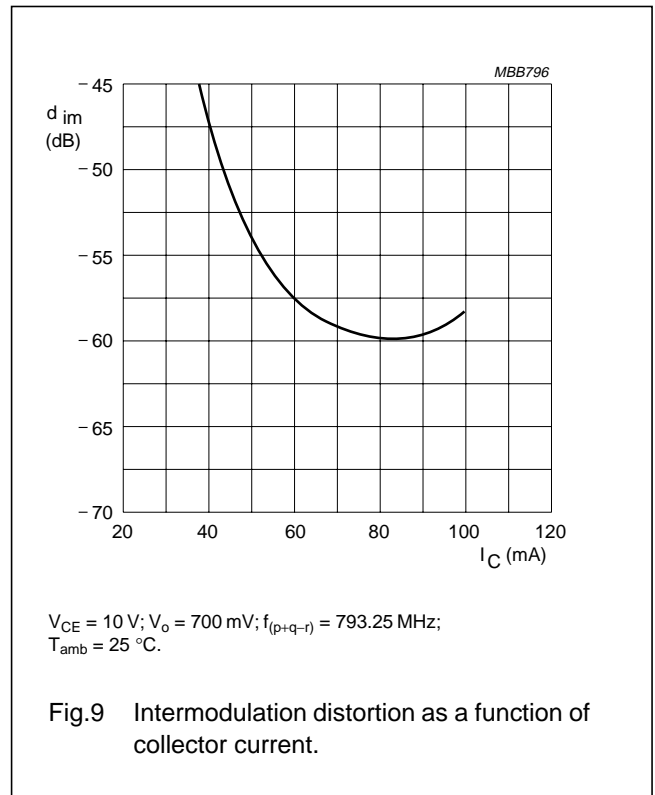
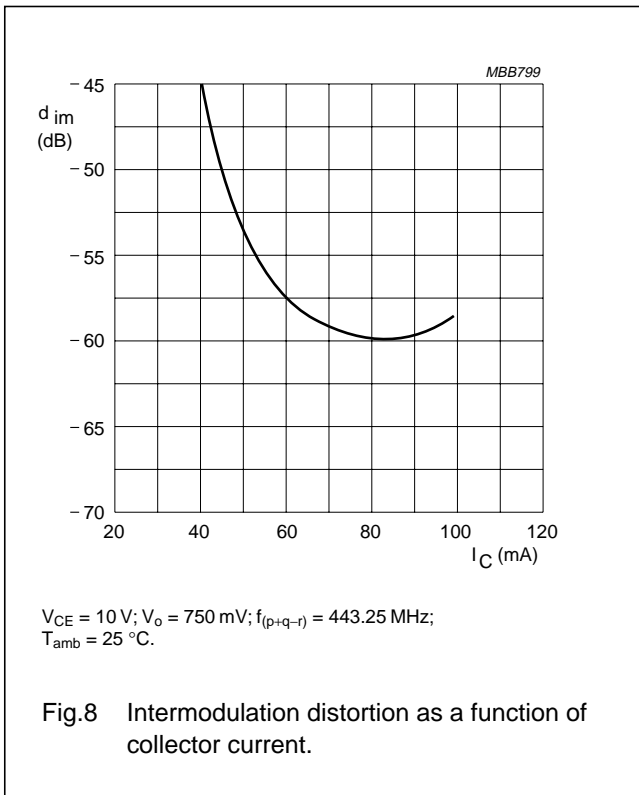

NPN 5 GHz wideband transistor

BFG97

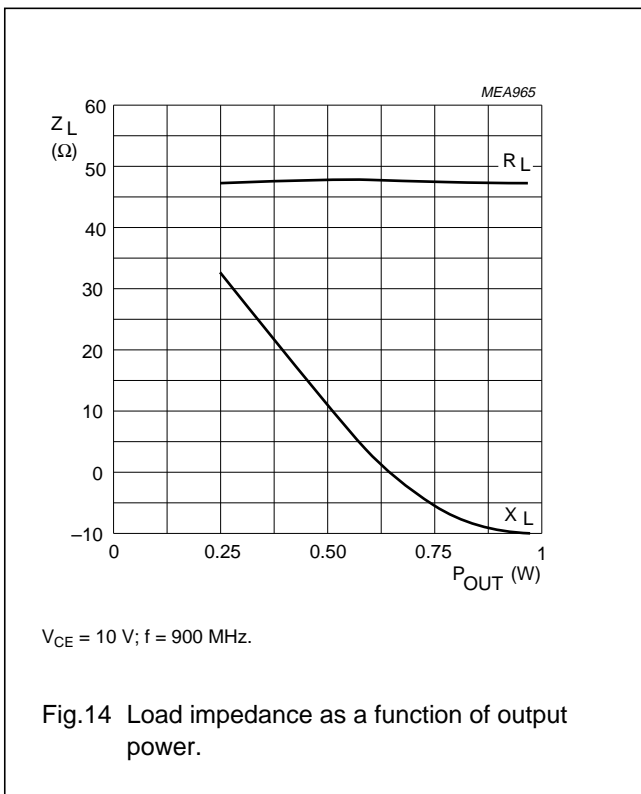
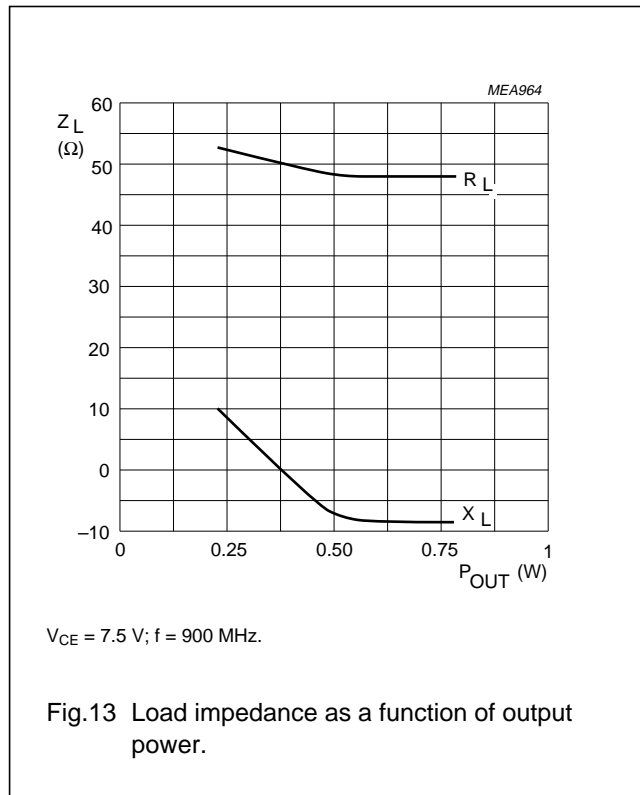
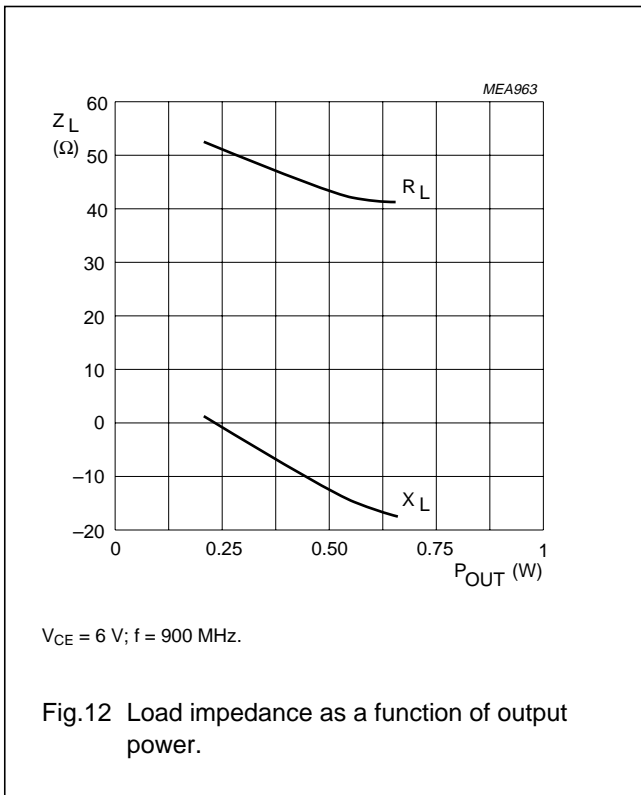



NPN 5 GHz wideband transistor

BFG97

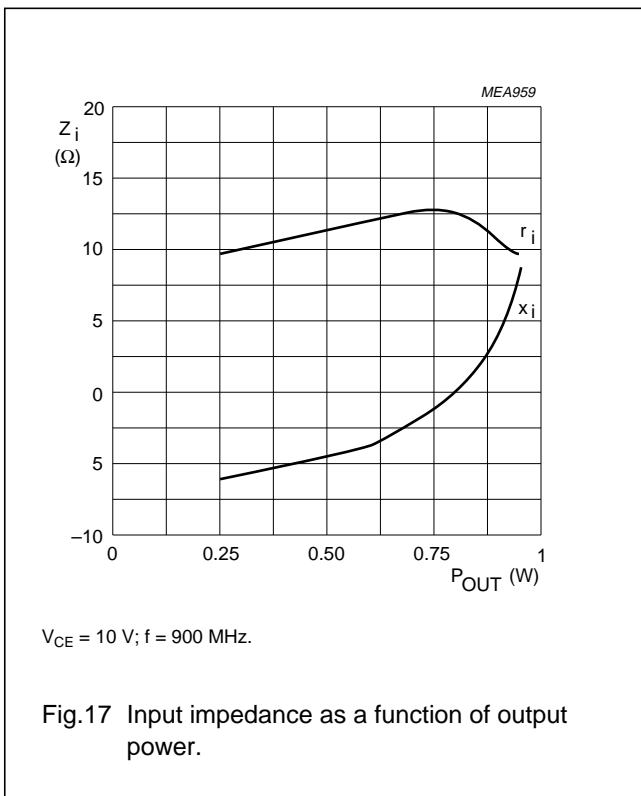
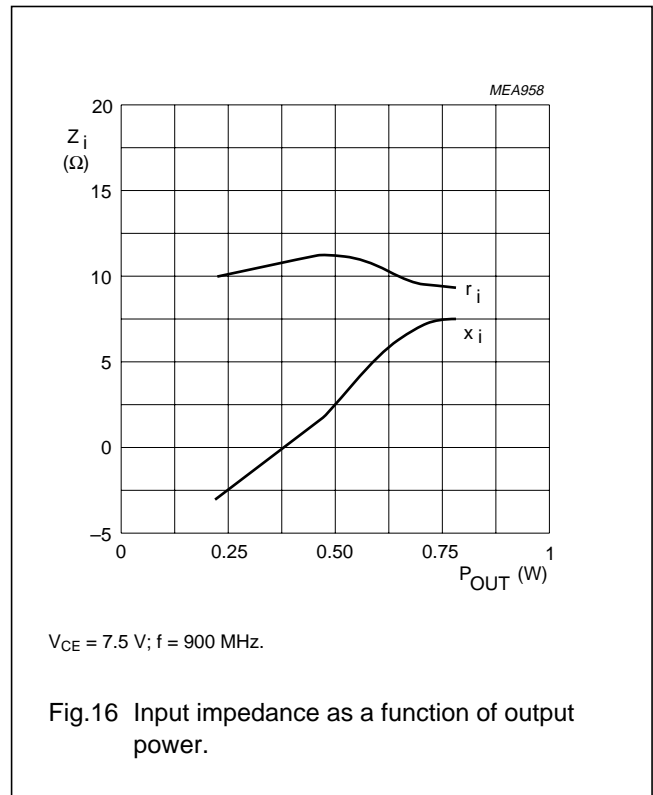
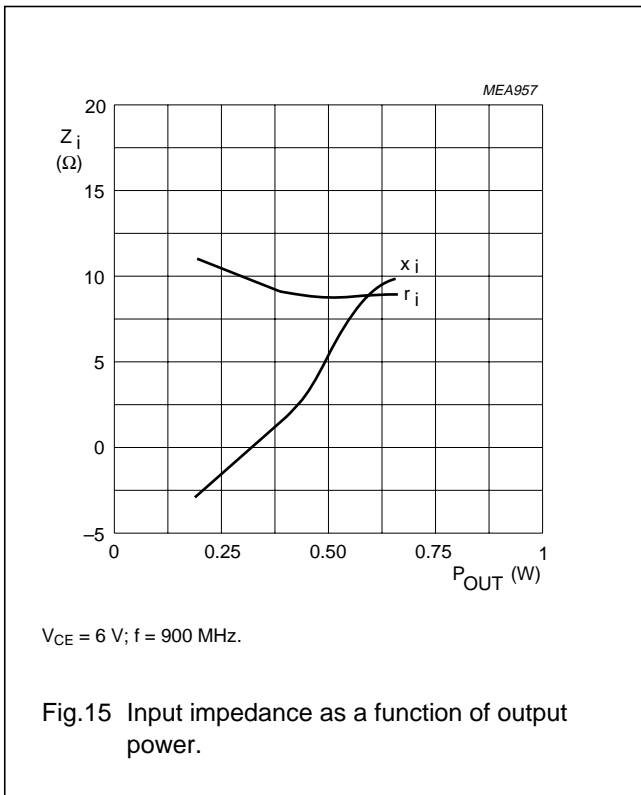

NPN 5 GHz wideband transistor

BFG97

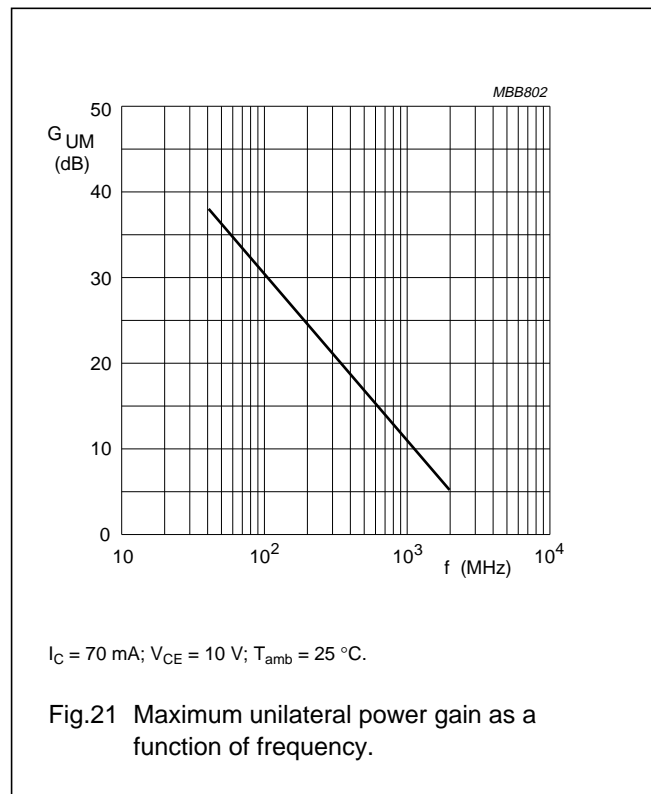
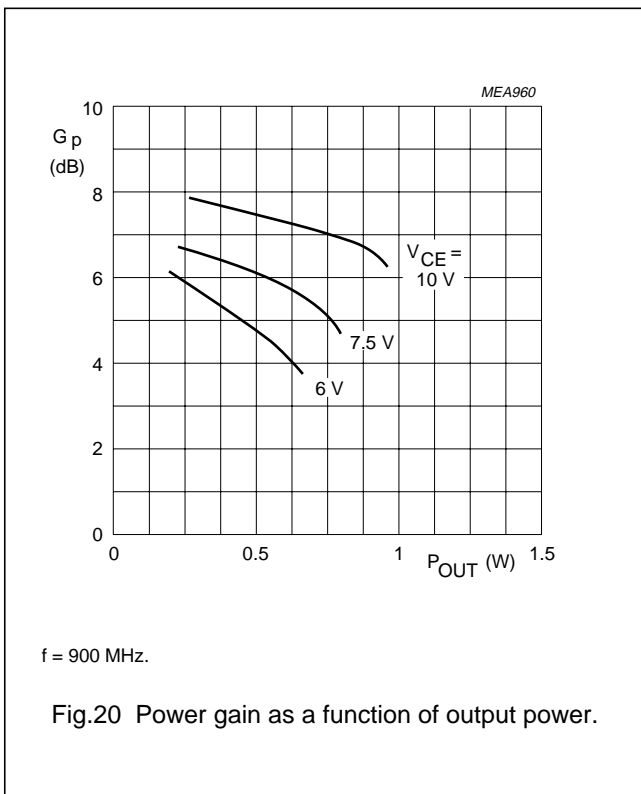
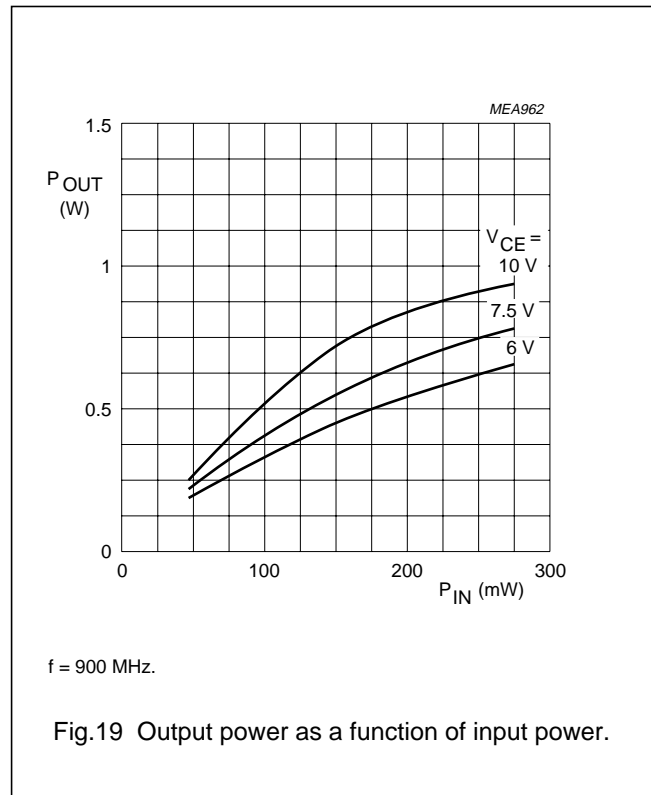
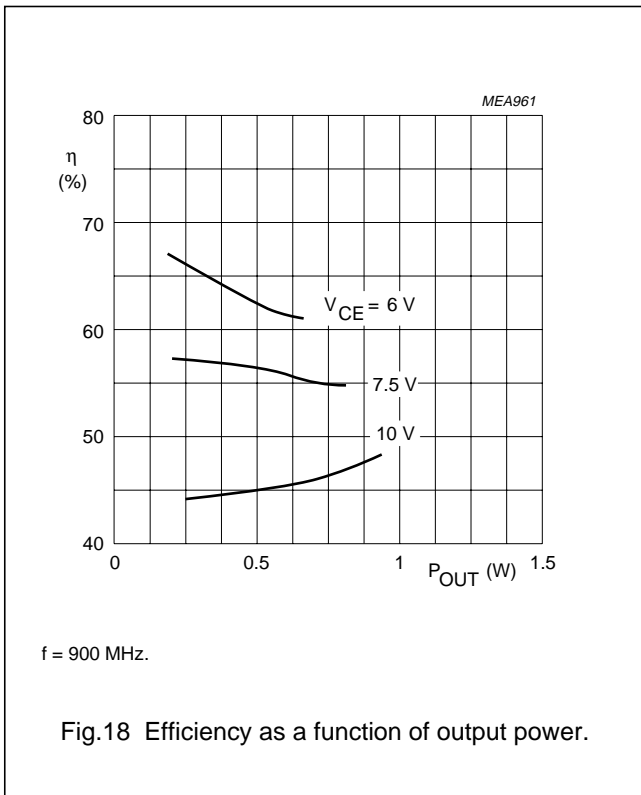

NPN 5 GHz wideband transistor

BFG97

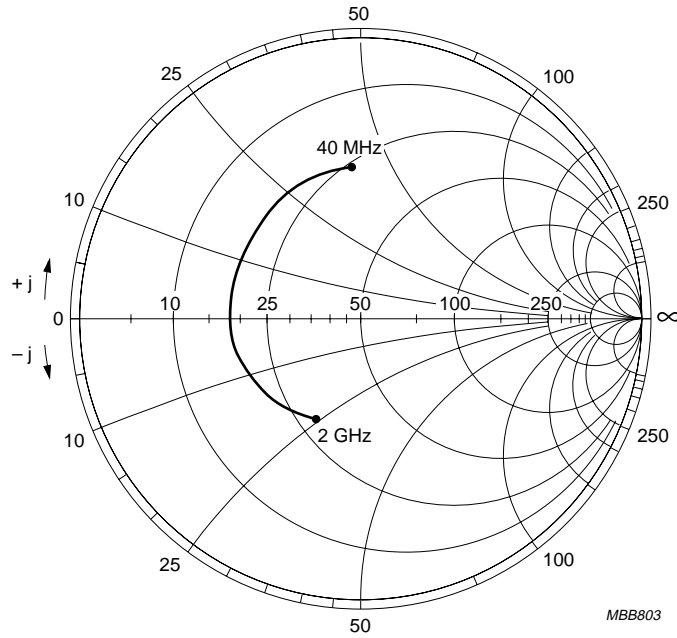

$I_C = 70 \text{ mA}$ ;  $V_{CE} = 10 \text{ V}$ ;  $T_{amb} = 25 \text{ }^\circ\text{C}$ .  
 $Z_o = 50 \text{ } \Omega$ .

Fig.22 Common emitter input reflection coefficient ( $S_{11}$ ).

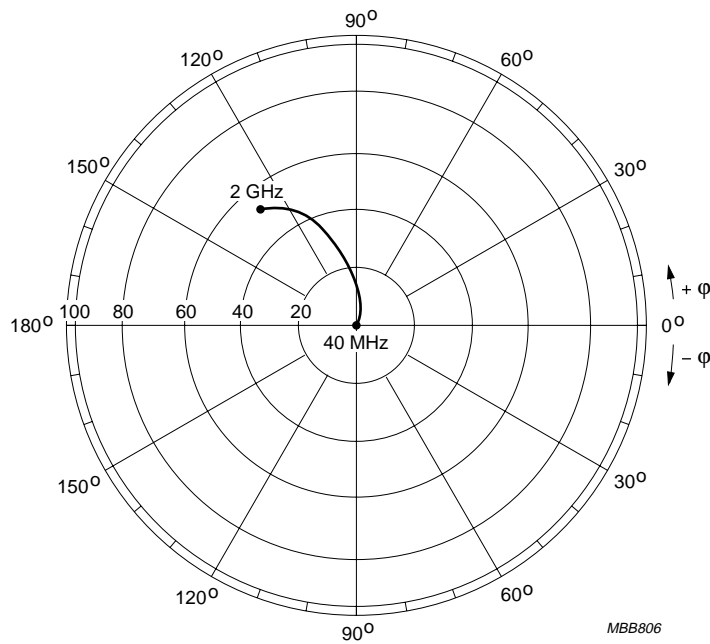

$I_C = 70 \text{ mA}$ ;  $V_{CE} = 10 \text{ V}$ ;  $T_{amb} = 25 \text{ }^\circ\text{C}$ .

Fig.23 Common emitter forward transmission coefficient ( $S_{21}$ ).

NPN 5 GHz wideband transistor

BFG97

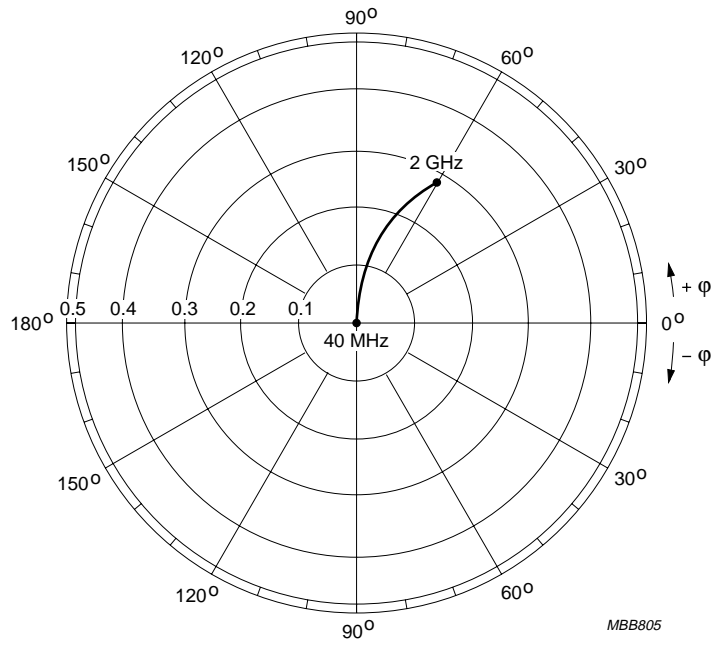

$I_C = 70 \text{ mA}; V_{CE} = 10 \text{ V}; T_{amb} = 25 \text{ }^\circ\text{C}.$

Fig.24 Common emitter reverse transmission coefficient ( $S_{12}$ ).

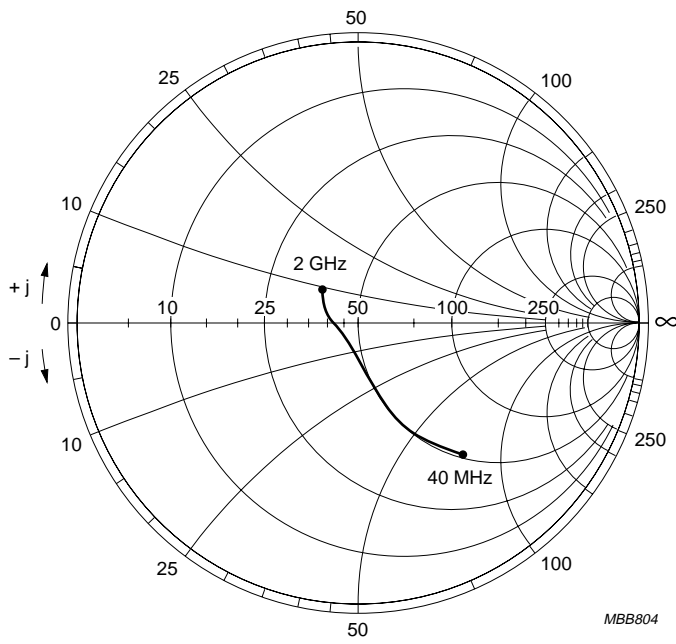

$I_C = 70 \text{ mA}; V_{CE} = 10 \text{ V}; T_{amb} = 25 \text{ }^\circ\text{C}.$   
 $Z_0 = 50 \text{ } \Omega.$

Fig.25 Common emitter output reflection coefficient ( $S_{22}$ ).

NPN 5 GHz wideband transistor

BFG97

PACKAGE OUTLINE

Plastic surface mounted package; collector pad for good heat transfer; 4 leads

SOT223

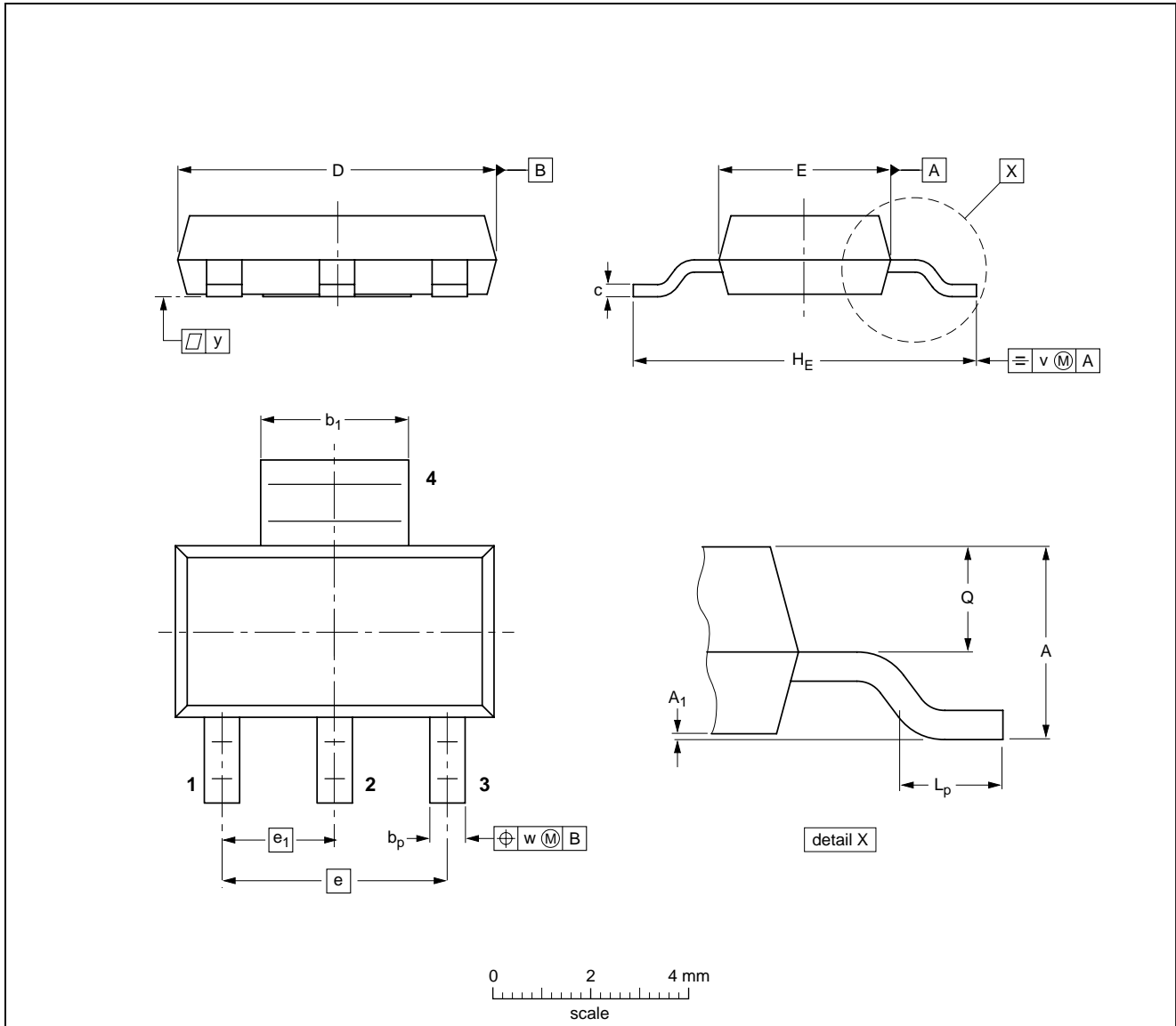

DIMENSIONS (mm are the original dimensions)

UNIT	A	A <sub>1</sub>	b <sub>p</sub>	b <sub>1</sub>	c	D	E	e	e <sub>1</sub>	H <sub>E</sub>	L <sub>p</sub>	Q	v	w	y
mm	1.8 1.5	0.10 0.01	0.80 0.60	3.1 2.9	0.32 0.22	6.7 6.3	3.7 3.3	4.6	2.3	7.3 6.7	1.1 0.7	0.95 0.85	0.2	0.1	0.1

OUTLINE VERSION	REFERENCES				EUROPEAN PROJECTION	ISSUE DATE
	IEC	JEDEC	EIAJ			
SOT223						96-11-11 97-02-28

## NPN 5 GHz wideband transistor

BFG97

**DEFINITIONS**

<b>Data Sheet Status</b>	
Objective specification	This data sheet contains target or goal specifications for product development.
Preliminary specification	This data sheet contains preliminary data; supplementary data may be published later.
Product specification	This data sheet contains final product specifications.
<b>Limiting values</b>	
Limiting values given are in accordance with the Absolute Maximum Rating System (IEC 134). Stress above one or more of the limiting values may cause permanent damage to the device. These are stress ratings only and operation of the device at these or at any other conditions above those given in the Characteristics sections of the specification is not implied. Exposure to limiting values for extended periods may affect device reliability.	
<b>Application information</b>	
Where application information is given, it is advisory and does not form part of the specification.	

**LIFE SUPPORT APPLICATIONS**

These products are not designed for use in life support appliances, devices, or systems where malfunction of these products can reasonably be expected to result in personal injury. Philips customers using or selling these products for use in such applications do so at their own risk and agree to fully indemnify Philips for any damages resulting from such improper use or sale.