

### Silicon Schottky Diode

- Low barrier diode for detectors up to GHz frequencies

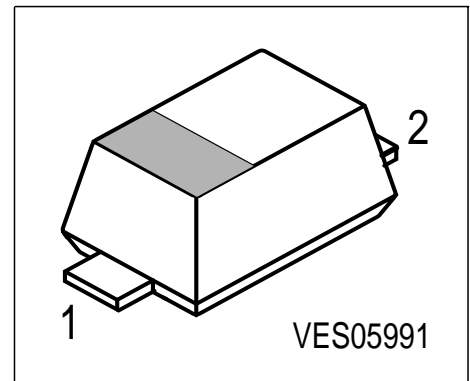

**ESD:** Electrostatic discharge sensitive device, observe handling precaution

Type	Marking	Ordering Code	Pin Configuration		Package
BAT 62-02W	L	Q62702-A1028	1 = C	2 = A	SCD-80

### Maximum Ratings

Parameter	Symbol	Value	Unit
Diode reverse voltage	$V_R$	40	V
Forward current	$I_F$	40	mA
Junction temperature	$T_j$	150	°C
Storage temperature	$T_{stg}$	-55 ...+150	

### Thermal Resistance

Junction - ambient <sup>1)</sup>	$R_{thJA}$	≤ 650	K/W
Junction - soldering point	$R_{thJS}$	≤ 810	

1) Package mounted on epoxy pcb 15mm x 16.7mm x 0.7mm

**Electrical Characteristics** at  $T_A = 25^\circ\text{C}$ , unless otherwise specified.

Parameter	Symbol	Values			Unit
		min.	typ.	max.	
<b>DC characteristics</b>					
Reverse current $V_R = 40\text{ V}$	$I_R$	-	-	10	$\mu\text{A}$
Forward voltage $I_F = 2\text{ mA}$	$V_F$	-	0.58	1	V
<b>AC characteristics</b>					
Diode capacitance $V_R = 1\text{ V}, f = 1\text{ MHz}$	$C_T$	-	0.35	0.6	pF
Case capacitance $f = 1\text{ MHz}$	$C_C$	-	0.09	-	
Differential resistance $V_R = 0, f = 10\text{ kHz}$	$R_0$	-	225	-	k $\Omega$
Series inductance chip to ground	$L_S$	-	0.6	-	nH

Forward current  $I_F = f(T_A^*; T_S)$

\* Package mounted on epoxy

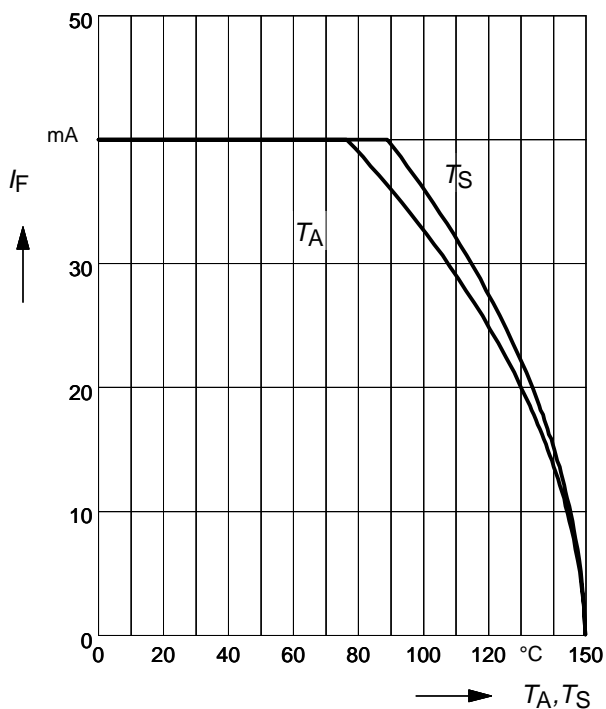

Permissible Pulse Load  $R_{thJS} = f(t_p)$

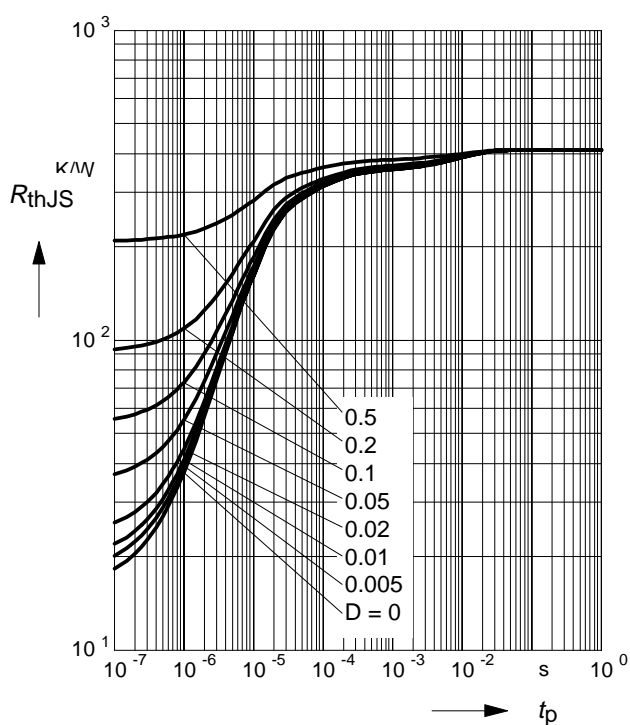

Permissible Pulse Load

$I_{Fmax} / I_{FDC} = f(t_p)$

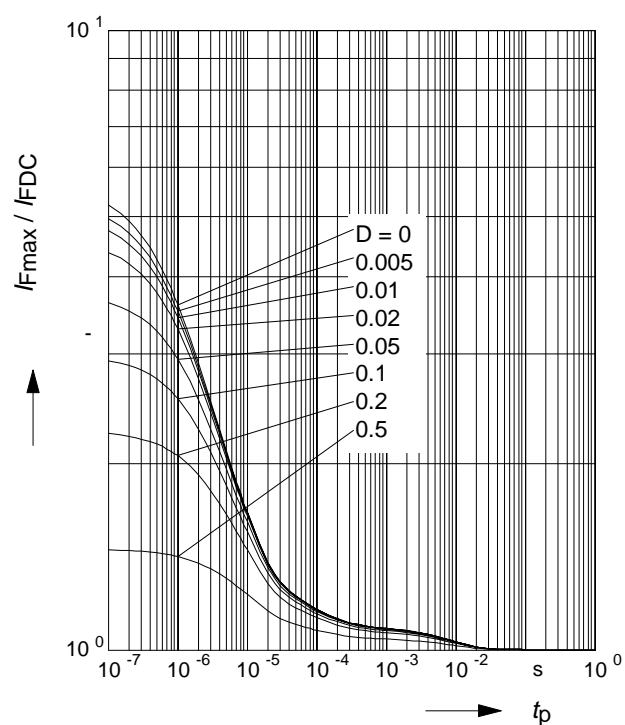

### Forward current $I_F = f(V_F)$

$T_A = \text{parameter}$

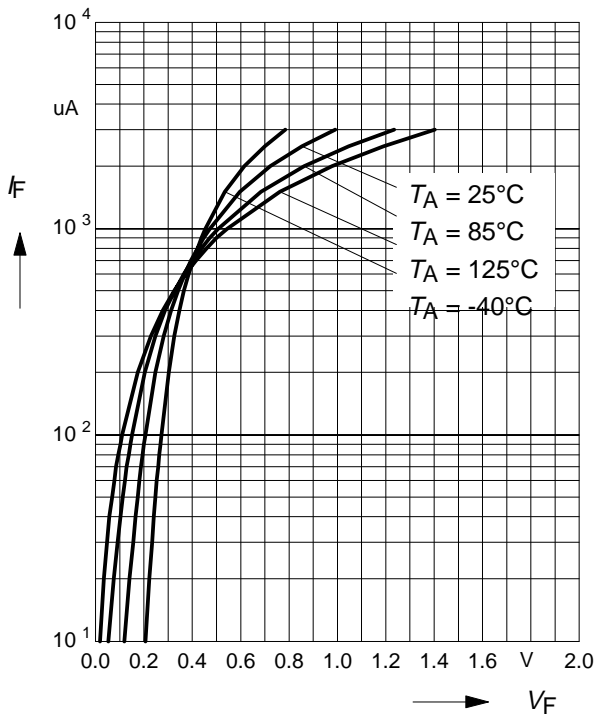

### Leakage current $I_R = f(V_R)$

$T_A = \text{Parameter}$

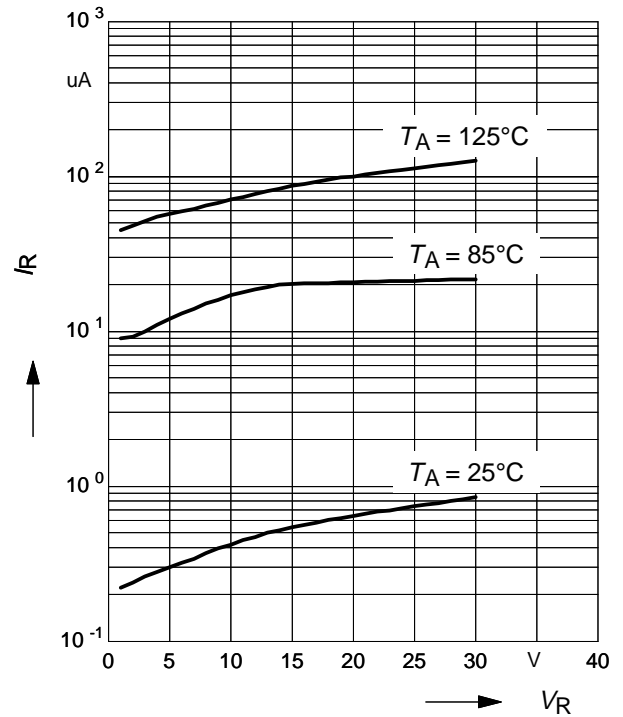

### Diode capacitance $C_T = f(V_R)$

$f = 1\text{MHz}$

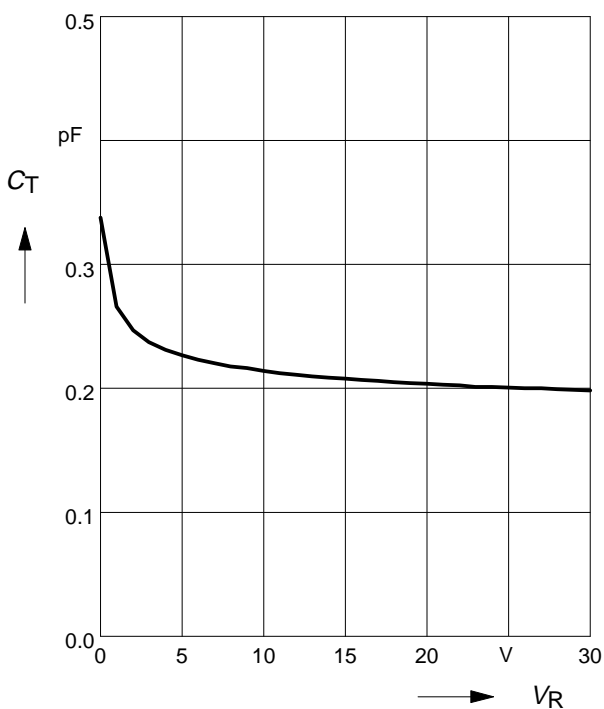

### Rectifier voltage $V_{out} = f(V_{in})$

$f = 900\text{ MHz}$

$R_L = \text{parameter in k}\Omega$

