

**VI TELEFILTER****Filter specification****TFS 299****1/5****Measurement condition**

Ambient temperature:	23	°C
Input power level:	0±2	dBm
Terminating impedance: *		
Input:	625 Ω	-5,3 pF
Output:	520 Ω	-5,1 pF

**Characteristics**

## Remark:

The nominal frequency  $f_N$  is fixed at 299 MHz. The insertion loss  $a_e$  is defined as loss value determined at  $f_N$ . Reference level for the relative attenuation  $a_{rel}$  of the TFS 299 is the insertion loss  $a_e$ . The centre frequency  $f_c$  is the arithmetic mean value of the upper and lower frequencies at the dB filter attenuation level relative to the insertion loss  $a_e$ . All specified data are met within the operating temperature range.

<b>D a t a</b>		<b>typ. value</b>		<b>tolerance / limit</b>	
<b>Insertion loss</b> (reference level)	$a_e$	6,2	dB	max.	8,0 dB
<b>Nominal frequency</b>	$f_N$	-			299,0 MHz
<b>Passband</b>	PB	-		$f_N$	± 80 kHz
<b>Pass band ripple</b>	p-p	0,3	dB	max.	±0,5 dB
<b>Bandwidth</b> 3 dB	BW	1,1	MHz	min.	400 kHz
<b>Relative attenuation</b>	$a_{rel}$				
$f_N \pm 1,8$ MHz ...	$f_N \pm 6,0$ MHz	23	dB	min.	20 dB
$f_N \pm 6,0$ MHz ...	$f_N \pm 60,0$ MHz	40	dB	min.	35 dB
$f_N - 298,0$ MHz ...	$f_N - 60,0$ MHz	45	dB	min.	20 dB
$f_N + 60,0$ MHz ...	$f_N + 701,0$ MHz	46	dB	min.	20 dB
<b>Absolute group delay at <math>f_N</math></b>		0,77	µs	max.	1 µs
<b>Group delay ripple within PB</b>	p-p	95	ns	max.	1 µs
<b>Input power level</b>		-		max.	+10 dBm
<b>Operating temperature range</b>	OTR	-			-40 °C ... + 85 °C
<b>Storage temperature range</b>		-			-40 °C ... + 90 °C
<b>Frequency inversion temperature</b>		25	°C		-
<b>Temperature coefficient of frequency</b>	$TC_f^{**}$	-0,036	ppm/K <sup>2</sup>		-

\*) The terminating impedances depend on parasitics and q-values of matching elements and the board used, and are to be understood as reference values only. Should there be additional questions do not hesitate to ask for an application note or contact our design team.

\*\*\*)  $\Delta f_c(\text{Hz}) = TC_f(\text{ppm/K}^2) \times (T - T_0)^2 \times f_{T_0}(\text{MHz})$ .

**Generated:****Checked / Approved:**

Tele Filter GmbH  
Potsdamer Straße 18  
D 14 513 TELTOW / Germany  
Tel: (+49) 3328 4784-0 / Fax: (+49) 3328 4784-30  
E-Mail: [tft@telefilter.com](mailto:tft@telefilter.com)

VI TELEFILTER reserves the right to make changes to the product(s) and/or information contained herein without notice. No liability is assumed as a result of their use or application. No rights under any patent accompany the sale of any such product(s) or information.

**Filter characteristic**

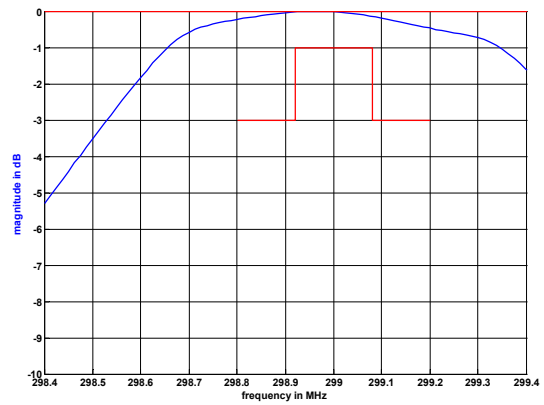
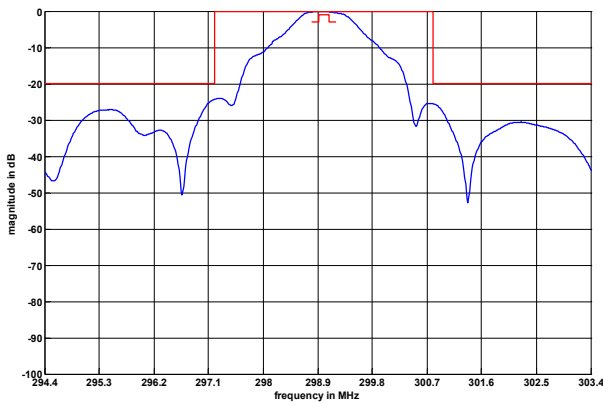

**Construction and pin connection**

(All dimensions in mm)

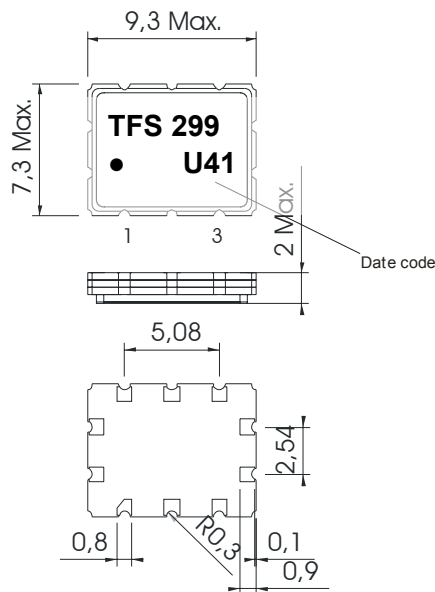

- 1 Output
- 2 Ground
- 3 Ground
- 4 Ground
- 5 Ground
- 6 Input
- 7 Ground
- 8 Ground
- 9 Ground
- 10 Ground

Date code: Year + week

- U 2006
- V 2007
- W 2008
- ...

**50 Ω Test circuit**

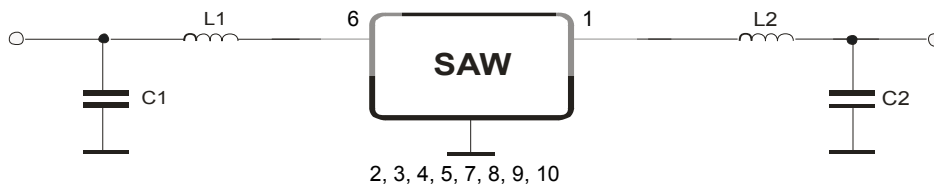

**Tele Filter GmbH**  
 Potsdamer Straße 18  
 D 14 513 TELTOW / Germany  
 Tel: (+49) 3328 4784-0 / Fax: (+49) 3328 4784-30  
 E-Mail: [tft@telefilter.com](mailto:tft@telefilter.com)

VI TELEFILTER reserves the right to make changes to the product(s) and/or information contained herein without notice. No liability is assumed as a result of their use or application. No rights under any patent accompany the sale of any such product(s) or information.

**Stability characteristics, reliability**

After the following tests the filter shall meet the whole specification:

1. Shock: 500g, 1 ms, half sine wave, 3 shocks each plane;  
DIN IEC 68 T2 - 27
2. Vibration: 10 Hz to 500 Hz, 0,35 mm or 5 g respectively, 1 octave per min, 10 cycles per plan, 3 plans;  
DIN IEC 68 T2 - 6
3. Change of temperature: -55 °C to 125°C / 30 min. each / 10 cycles  
DIN IEC 68 part 2 – 14 Test N
4. Resistance to solder heat (reflow): reflow possible: three times max.;  
for temperature conditions refer to the attached "Air reflow temperature conditions" on page 4;
5. ESD MIL-STD-883E using coupling network of ISO 10605 and EN 6100-4-2  
HBM:250V; MM:200V; CDM:V;

This filter is RoHS compliant (2002/95/EG, 2005/618/EG)

**Packing**

Tape & Reel: IEC 286 – 3, with exception of value for N and minimum bending radius;  
tape type II, embossed carrier tape with top cover tape on the upper side;

max. pieces of filters per reel:	2000
reel of empty components at start:	min. 300 mm
reel of empty components at start including leader:	min. 500 mm
trailer:	min. 300 mm

**Tape (all dimensions in mm)**

- W : 16,00 ± 0,3
- Po : 4,00 ± 0,1
- Do : 1,50 +0,1/-0
- E : 1,75 ± 0,10
- F : 7,50 ± 0,10
- G(min) : 0,60
- P2 : 2,00 ± 0,1
- P1 : 12,00 ± 0,1
- D1(min) : 1,50 +0,1/-0
- Ao : 7,60 ± 0,10
- Bo : 9,60 ± 0,10
- Ct : 13,5

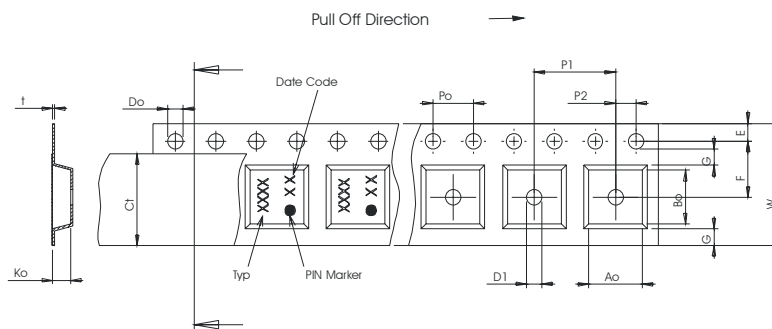

**Reel (all dimensions in mm)**

- A : 330
- W1 : 16,4
- W2(max) : 22,4
- N(min) : 50
- C : 13,0

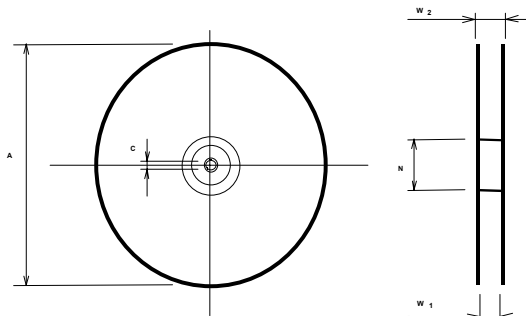

The minimum bending radius is 45 mm.

**Tele Filter GmbH**  
**Potsdamer Straße 18**  
**D 14 513 TELTOW / Germany**  
**Tel: (+49) 3328 4784-0 / Fax: (+49) 3328 4784-30**  
**E-Mail: [tft@telefilter.com](mailto:tft@telefilter.com)**

VI TELEFILTER reserves the right to make changes to the product(s) and/or information contained herein without notice. No liability is assumed as a result of their use or application. No rights under any patent accompany the sale of any such product(s) or information.

**Air reflow temperature conditions**

<b>Conditions</b>	<b>Exposure</b>
Average ramp-up rate (30°C to 217°C)	less than 3°C/second
> 100°C	between 300 and 600 seconds
> 150°C	between 240 and 500 seconds
> 217°C	between 30 and 150 seconds
Peak temperature	max. 260°C
Time within 5°C of actual peak temperature	between 10 and 30 seconds
Cool-down rate (Peak to 50°C)	less than 6°C/second
Time from 30°C to Peak temperature	no greater than 300 seconds

**Chip-mount air reflow profile**

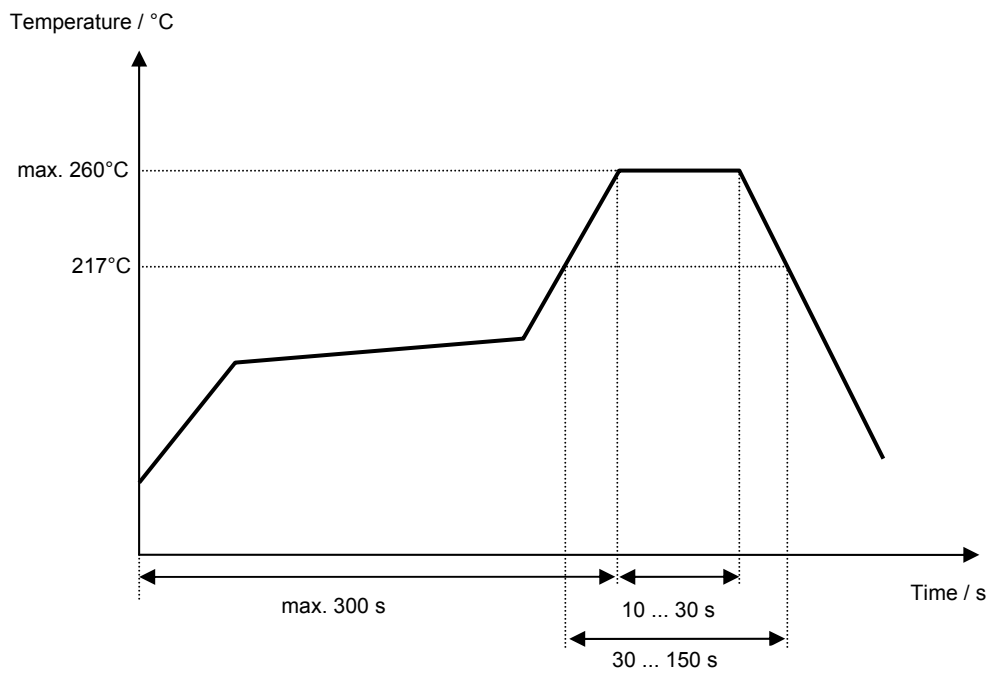

**Tele Filter GmbH**  
**Potsdamer Straße 18**  
**D 14 513 TELTOW / Germany**  
**Tel: (+49) 3328 4784-0 / Fax: (+49) 3328 4784-30**  
**E-Mail: [tft@telefilter.com](mailto:tft@telefilter.com)**

VI TELEFILTER reserves the right to make changes to the product(s) and/or information contained herein without notice. No liability is assumed as a result of their use or application. No rights under any patent accompany the sale of any such product(s) or information.

**VI TELEFILTER****Filter specification****TFS 299****5/5****History**

<b>Version</b>	<b>Reason of Changes</b>	<b>Name</b>	<b>Date</b>
1.6	- impedances modified - date code changed and explained	Steiner	24.03.2000
1.7	- tape and reel dimensions corrected	Steiner	12.07.2000
1.8.	- ESD limits added - Storage temperatur range added - Change remark	Strehl	17.09.2004
1.9	- Add typ. value and filter characteristic	Strehl	13.10.2006

---

**Tele Filter GmbH**  
**Potsdamer Straße 18**  
**D 14 513 TELTOW / Germany**  
**Tel: (+49) 3328 4784-0 / Fax: (+49) 3328 4784-30**  
**E-Mail: [tft@telefilter.com](mailto:tft@telefilter.com)**

VI TELEFILTER reserves the right to make changes to the product(s) and/or information contained herein without notice. No liability is assumed as a result of their use or application. No rights under any patent accompany the sale of any such product(s) or information.