

Typical Performance

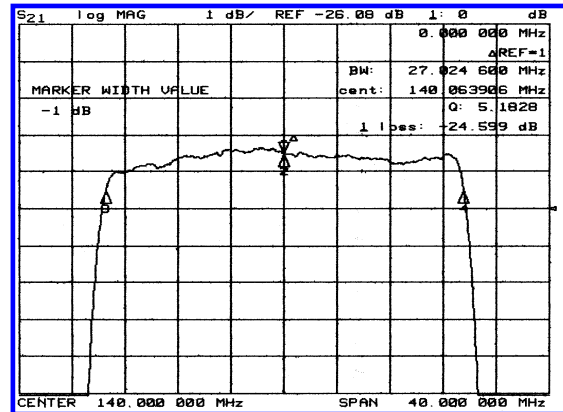
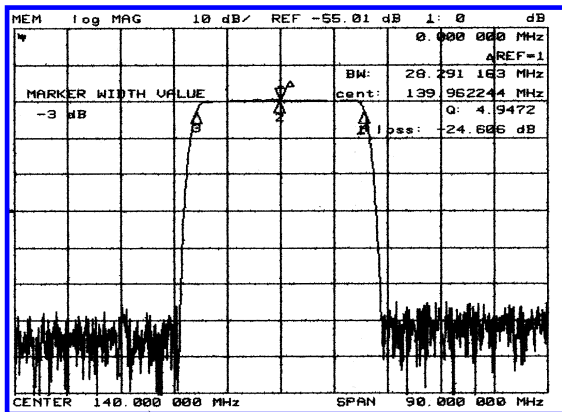

Specification

Parameter	Unit	Min.	Typ.	Max.
Center Frequency	Mhz	139.85	140.00	140.15
Insertion Loss	dB	-	24.0	25.5
1dB Bandwidth	Mhz	26.70	27.00	-
3dB Bandwidth	Mhz	28.00	28.20	-
40dB Bandwidth	Mhz	-	33.00	33.30
Passband Ripple	dB	-	0.75	1.00
Group Delay Variation	nsec	-	70	120
Absolute Delay	µsec	-	1.06	-
Ultimate Attenuation	dB	50	60	-
Substrate Material	-	128 LiNbO ₃		

Package Dimension

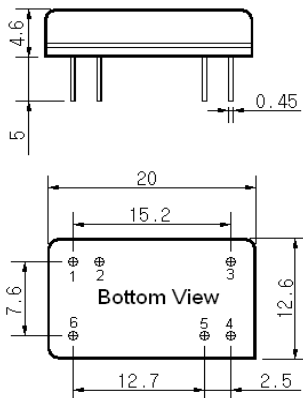

Matching Configuration

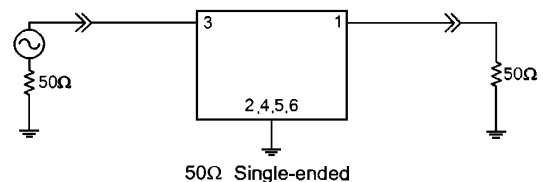

No Matching Required
Source / Load Impedance = 50Ω
Ambient Temperature = 25°C

12-01-2001