

# Cascadable Silicon Bipolar MMIC Amplifier

## Technical Data

### MSA-0910

#### Features

- **Broadband, Minimum Ripple Cascadable 50 Ω Gain Block**
- **8.0 ± 0.2 dB Typical Gain Flatness from 0.1 to 4.0 GHz**
- **3 dB Bandwidth:** 0.1 to 6.0 GHz
- **Low VSWR:** ≤ 1.5:1 from 0.1 to 4.0 GHz
- **11.5 dBm Typical P<sub>1dB</sub> at 1.0 GHz**
- **Hermetic Gold-ceramic Microstrip Package**

#### Description

The MSA-0910 is a high performance silicon bipolar Monolithic Microwave Integrated Circuit (MMIC) housed in a hermetic, high reliability package. This MMIC is designed for very wide bandwidth industrial and military applications that require flat gain and low VSWR.

The MSA-series is fabricated using HP's 10 GHz  $f_T$ , 25 GHz  $f_{MAX}$ , silicon bipolar MMIC process which uses nitride self-alignment, ion implantation, and gold metallization to achieve excellent performance, uniformity and reliability. The use of an external bias resistor for temperature and current stability also allows bias flexibility.

#### 100 mil Package

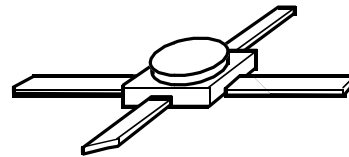

#### Typical Biasing Configuration

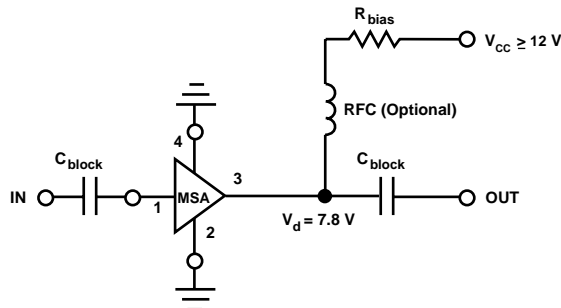

## MSA-0910 Absolute Maximum Ratings

Parameter	Absolute Maximum <sup>[1]</sup>
Device Current	80 mA
Power Dissipation <sup>[2,3]</sup>	750 mW
RF Input Power	+13 dBm
Junction Temperature	200°C
Storage Temperature	-65 to 200°C

### Thermal Resistance<sup>[2,4]</sup>:

$$\theta_{jc} = 145^{\circ}\text{C/W}$$

#### Notes:

1. Permanent damage may occur if any of these limits are exceeded.
2.  $T_{\text{CASE}} = 25^{\circ}\text{C}$ .
3. Derate at  $6.9 \text{ mW}/^{\circ}\text{C}$  for  $T_{\text{C}} > 91^{\circ}\text{C}$ .
4. The small spot size of this technique results in a higher, though more accurate determination of  $\theta_{jc}$  than do alternate methods. See MEASUREMENTS section "Thermal Resistance" for more information.

## Electrical Specifications<sup>[1]</sup>, $T_{\text{A}} = 25^{\circ}\text{C}$

Symbol	Parameters and Test Conditions: $I_{\text{d}} = 35 \text{ mA}$ , $Z_{\text{o}} = 50 \Omega$	Units	Min.	Typ.	Max.
$G_{\text{P}}$	PowerGain ( $ S_{21} ^2$ ) $f = 0.1 \text{ GHz}$	dB	7.0	8.0	9.0
$\Delta G_{\text{P}}$	Gain Flatness $f = 0.1 \text{ to } 4.0 \text{ GHz}$	dB		$\pm 0.2$	$\pm 0.5$
$f_{3 \text{ dB}}$	3 dB Bandwidth <sup>[2]</sup>	GHz		6.0	
VSWR	Input VSWR $f = 1.0 \text{ to } 4.0 \text{ GHz}$			1.3:1	
	Output VSWR $f = 1.0 \text{ to } 4.0 \text{ GHz}$			1.5:1	
NF	50 $\Omega$ Noise Figure $f = 1.0 \text{ GHz}$ $f = 4.0 \text{ GHz}$	dB		6.0 6.5	
$P_{1 \text{ dB}}$	Output Power at 1 dB Gain Compression $f = 1.0 \text{ GHz}$ $f = 4.0 \text{ GHz}$	dBm		11.5 6.5	
$\text{IP}_3$	Third Order Intercept Point $f = 1.0 \text{ GHz}$	dBm		23.0	
$t_{\text{D}}$	Group Delay $f = 1.0 \text{ GHz}$	psec		100	
$V_{\text{d}}$	Device Voltage	V	7.0	7.8	8.6
$dV/dT$	Device Voltage Temperature Coefficient	mV/ $^{\circ}\text{C}$		-16.0	

#### Notes:

1. The recommended operating current range for this device is 25 to 45 mA. Typical performance as a function of current is on the following page.
2. Referenced from 0.1 GHz gain ( $G_{\text{P}}$ ).

### MSA-0910 Typical Scattering Parameters ( $Z_0 = 50 \Omega$ , $T_A = 25^\circ\text{C}$ , $I_d = 35 \text{ mA}$ )

Freq. GHz	$S_{11}$		$S_{21}$			$S_{12}$			$S_{22}$		k
	Mag	Ang	dB	Mag	Ang	dB	Mag	Ang	Mag	Ang	
0.02	.31	-108	10.6	3.38	150	-13.8	.202	16	.31	-107	0.85
0.05	.18	-114	8.8	2.75	160	-13.5	.212	8	.20	-117	1.06
0.1	.12	-141	8.1	2.53	166	-13.4	.214	3	.14	-139	1.16
0.2	.10	-166	7.9	2.47	167	-13.4	.215	1	.13	-157	1.19
0.4	.10	170	7.8	2.46	163	-13.3	.215	-1	.12	-165	1.20
0.6	.10	156	7.8	2.45	157	-13.3	.216	-3	.13	-167	1.20
0.8	.10	145	7.8	2.46	151	-13.3	.216	-4	.13	-168	1.19
1.0	.10	133	7.8	2.46	144	-13.3	.217	-6	.14	-169	1.19
1.5	.10	111	7.9	2.49	127	-13.2	.220	-10	.16	-173	1.17
2.0	.09	88	8.0	2.51	110	-13.0	.224	-13	.18	177	1.15
2.5	.07	89	8.2	2.58	96	-12.8	.230	-16	.21	167	1.11
3.0	.04	90	8.2	2.58	78	-12.8	.230	-21	.20	151	1.11
3.5	.06	145	8.2	2.57	59	-12.7	.233	-27	.19	137	1.11
4.0	.12	152	8.0	2.50	40	-12.7	.230	-33	.16	125	1.12
4.5	.19	142	7.5	2.38	22	-13.0	.223	-40	.13	116	1.16
5.0	.26	131	6.9	2.21	4	-13.5	.211	-47	.09	118	1.22
5.5	.32	120	6.2	2.04	-12	-14.1	.198	-52	.07	160	1.28
6.0	.38	109	5.3	1.84	-27	-14.8	.181	-56	.13	-173	1.38
6.5	.43	99	4.4	1.65	-42	-15.6	.167	-59	.21	-172	1.46

A model for this device is available in the DEVICE MODELS section.

### Typical Performance, $T_A = 25^\circ\text{C}$

(unless otherwise noted)

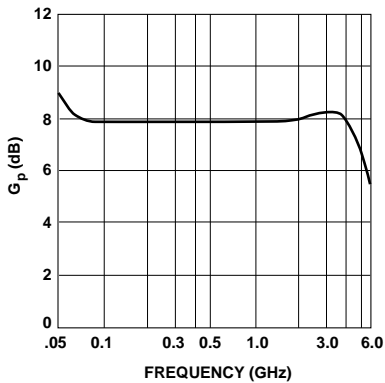

Figure 1. Typical Power Gain vs. Frequency,  $I_d = 35 \text{ mA}$ .

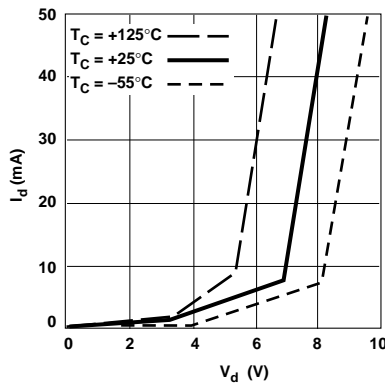

Figure 2. Device Current vs. Voltage.

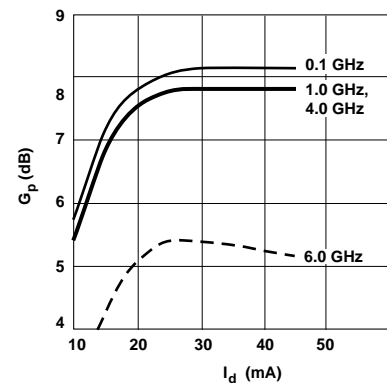

Figure 3. Power Gain vs. Current.

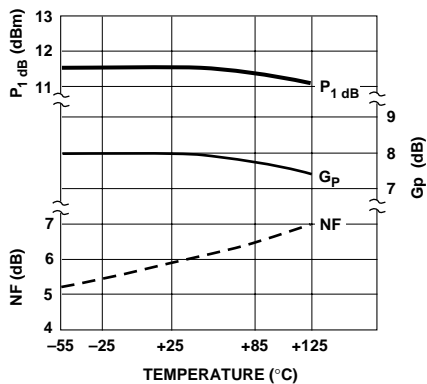

Figure 4. Output Power at 1 dB Gain Compression, Noise Figure and Power Gain vs. Case Temperature,  $f = 1.0 \text{ GHz}$ ,  $I_d = 35 \text{ mA}$ .

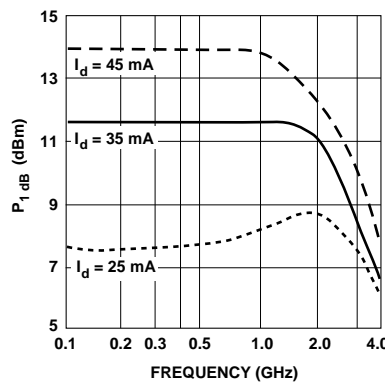

Figure 5. Output Power at 1 dB Gain Compression vs. Frequency.

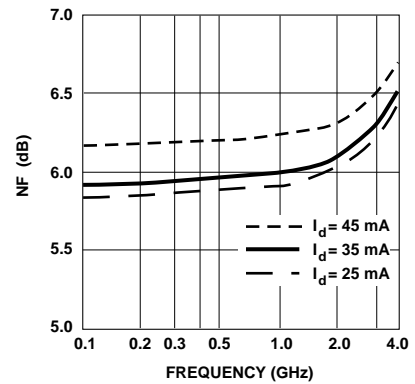

Figure 6. Noise Figure vs. Frequency.

# 100 mil Package Dimensions

## Outline 10A

