

FEATURES

- **HIGH GAIN:** 20 dB at 900 to 1500 MHz Typical
- **HIGH OUTPUT POWER:** $P_{SAT} = +12.5$ dBm at 900 MHz
+11 dBm at 1500 MHz
- **LOW BIAS VOLTAGE:** 3.0 V Typical, 2.7 V Minimum
- **SUPER SMALL PACKAGE**
- **TAPE AND REEL PACKAGING OPTION AVAILABLE**

DESCRIPTION

The UPC2771T is a Silicon Monolithic integrated circuit which is manufactured using the NESAT III process. The NESAT III process produces transistors with f_T approaching 20 GHz. This amplifier was designed as a driver amplifier for digital cellular applications. Operating on a 3 volt supply, this IC is ideally suited for hand-held, portable designs.

NEC's stringent quality assurance and test procedures ensure the highest reliability and performance.

GAIN vs. FREQUENCY AND TEMPERATURE

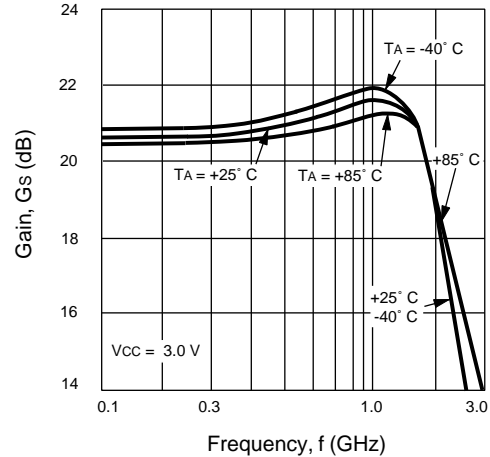

ELECTRICAL CHARACTERISTICS (TA = 25°C, ZL = Zs = 50 Ω, VCC = 3.0 V)

PART NUMBER			UPC2771T		
PACKAGE OUTLINE			T06		
SYMBOLS	PARAMETERS AND CONDITIONS	UNITS	MIN	TYP	MAX
I _{CC}	Circuit Current (no signal)	mA		36	45
G _s	Small Signal Gain, f = 900 MHz f = 1500 MHz	dB dB	19 17	21 20	24 23
f _u	Upper Limit Operating Frequency (The gain at f _u is 3 dB down from the gain at 100 MHz)	GHz	1.7	2.1	
P _{1dB}	1 dB Compressed Output Power, f = 900 MHz f = 1500 MHz	dBm dBm	+9 +7	+11.5 +9.5	
P _{SAT}	Saturated Output Power, f = 900 MHz f = 1500 MHz	dBm dBm		+12.5 +11	
NF	Noise Figure, f = 900 MHz f = 1500 MHz	dB dB		6 6	7.5 7.5
RL _{IN}	Input Return Loss, f = 900 MHz f = 1500 MHz	dB dB	10 10	14 14	
RL _{OUT}	Output Return Loss, f = 900 MHz f = 1500 MHz	dB dB	6.5 5.5	9.5 8.5	
ISOL	Isolation, f = 900 MHz f = 1500 MHz	dB dB	25 25	30 30	
OIP3	SSB Output Third Order Intercept Point f = 900, 902 MHz f = 1500, 1502 MHz	dBm dBm		+16 +13	

ABSOLUTE MAXIMUM RATINGS¹ (T_A = 25°C)

SYMBOLS	PARAMETERS	UNITS	RATINGS
V _{CC}	Supply Voltage	V	3.6
I _{CC}	Total Supply Current	mA	77.7
P _{IN}	Input Power	dBm	+13
P _T	Total Power Dissipation ²	mW	280
T _{OP}	Operating Temperature	°C	-40 to +85
T _{STG}	Storage Temperature	°C	-55 to +150

Notes:

1. Operation in excess of any one of these parameters may result in permanent damage.
2. Mounted on a 50 X 50 X 1.6 mm epoxy glass PWB (T_A = 85°C).

RECOMMENDED OPERATING CONDITIONS

SYMBOLS	PARAMETERS	UNITS	MIN	TYP	MAX
V _{CC}	Supply Voltage	V	2.7	3	3.3
T _{OP}	Operating Temperature	°C	-40	+25	+85

TYPICAL PERFORMANCE CURVES (T_A = 25°C)

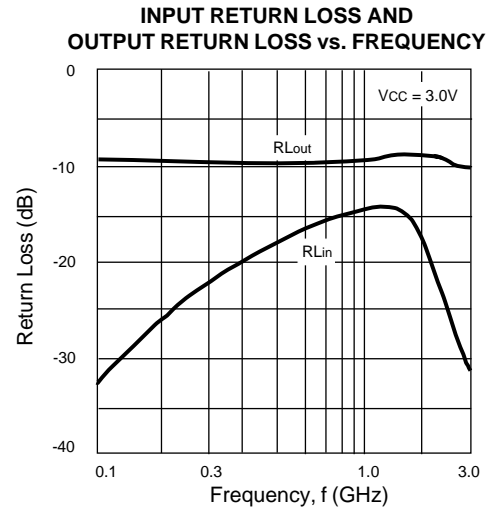
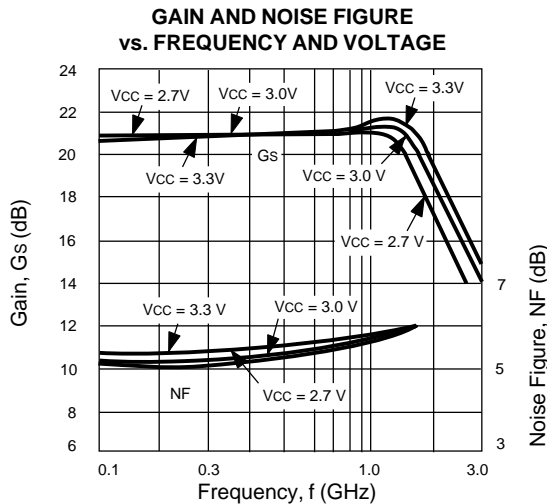
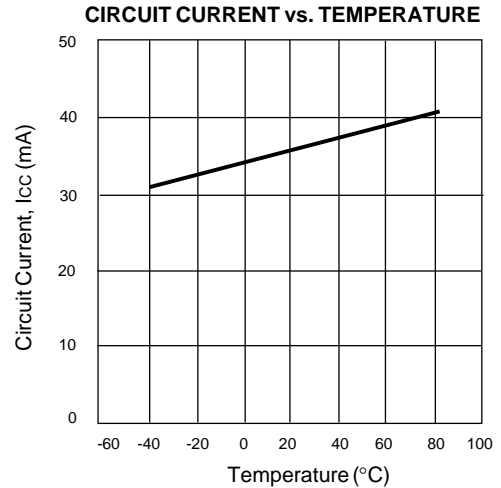
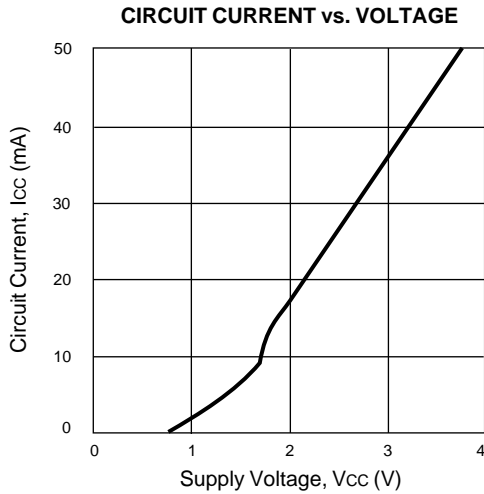

TEST CIRCUIT

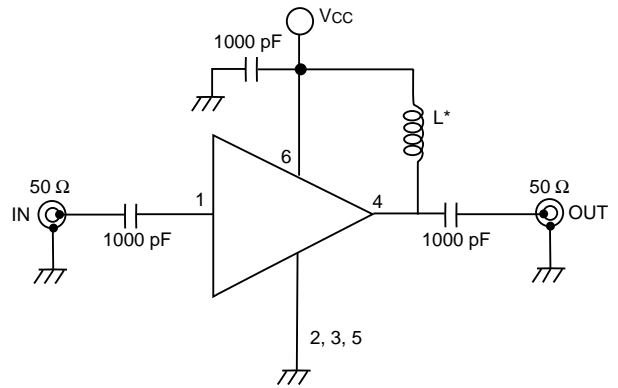

* This device is tested using a bias tee with typical series inductance, L = 1000 nH. In circuit applications, L = 50 nH is satisfactory at 900 MHz, and L = 10 nH is satisfactory at 1500 MHz.

TYPICAL PERFORMANCE CURVES ($T_A = 25^\circ$)

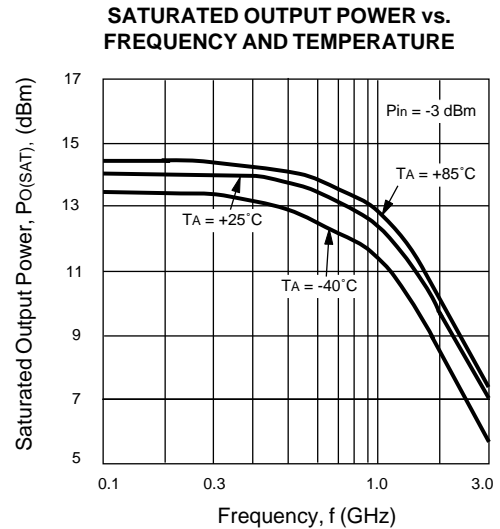
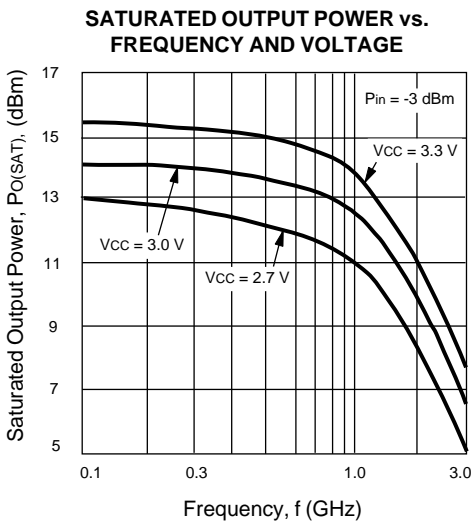
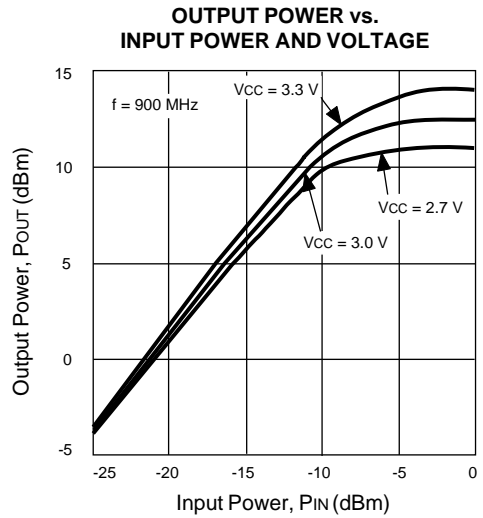
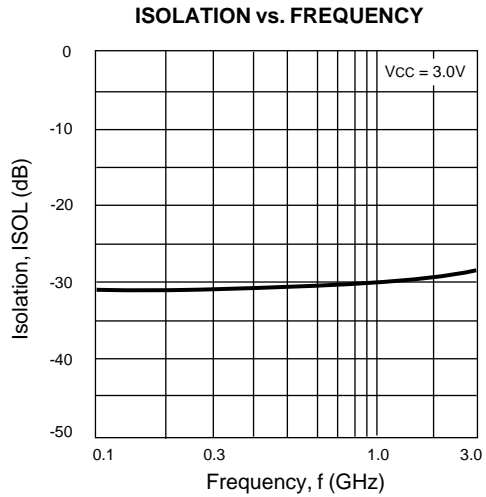

S11 vs. FREQUENCY
($V_{CC} = 3.0\text{ V}$)

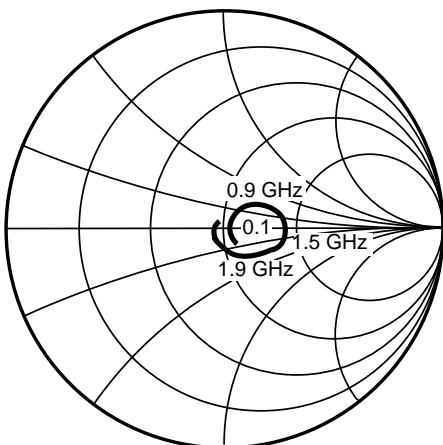

S22 vs. FREQUENCY
($V_{CC} = 3.0\text{ V}$)

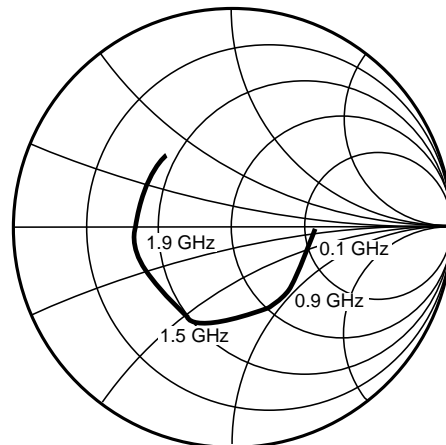

UPC2771T

OUTLINE DIMENSIONS (Units in mm)

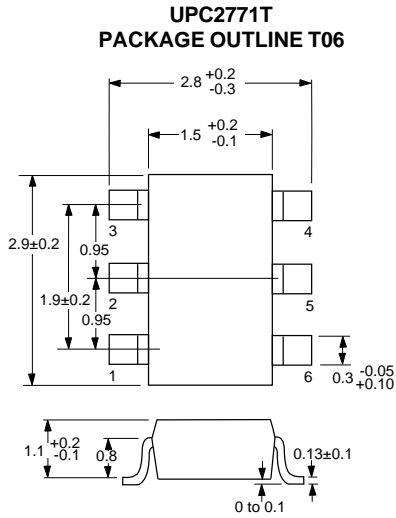

LEAD CONNECTIONS

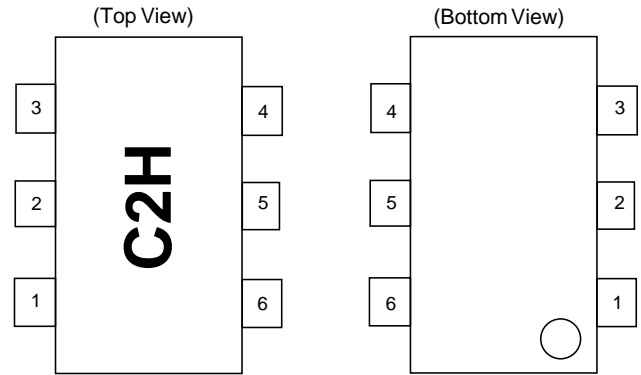

1. INPUT
2. GND
3. GND
4. OUTPUT
5. GND
6. Vcc

RECOMMENDED P.C.B. LAYOUT (Units in mm)

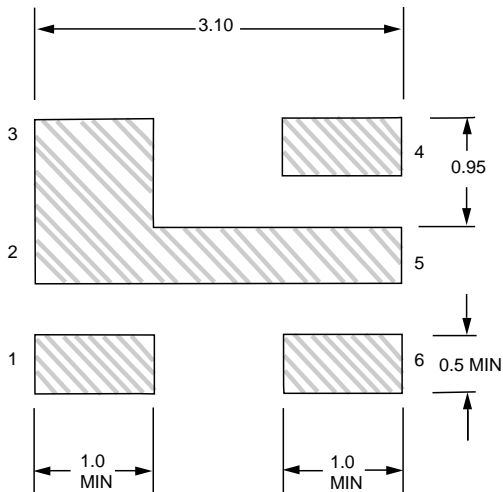

Note:
All dimensions are typical unless otherwise specified.

EQUIVALENT CIRCUIT

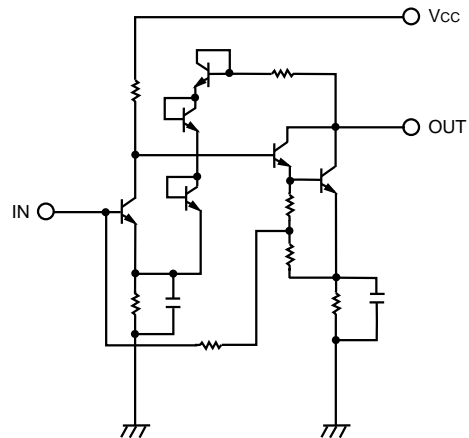

ORDERING INFORMATION

PART NUMBER	QTY
UPC2771T-E3	3K/Reel

Note:
Embossed Tape, 8 mm wide.

EXCLUSIVE AGENT FOR **NEC Corporation** RF & MICROWAVE SEMICONDUCTOR PRODUCTS - U.S. & CANADA

CALIFORNIA EASTERN LABORATORIES, INC • Headquarters • 4590 Patrick Henry Drive • Santa Clara, CA 95054-1817 • (408) 988-3500 • Telex 34-6393/FAX (408) 988-0279

DATA SUBJECT TO CHANGE WITHOUT NOTICE



PRINTED IN USA ON RECYCLED PAPER 11/95