

# OKI electronic components

## KGF1522

### Small-Signal Amplifier

#### GENERAL DESCRIPTION

The KGF1522 is a high performance GaAs FET small-signal amplifier for L-band frequencies that features low voltage operation, low current operation, low noise, and low distortion. The KGF1522 specifications are guaranteed to a fixed matching circuit for 3 V and 1.9 GHz; external impedance-matching circuits are also required. Because of its high 3rd-order intercept point, even at its low operating current, the KGF1522 is ideal as a signal amplifier for L-band personal handy phones, such as digital keying cordless phones that require low intermodulation properties.

#### FEATURES

- Low voltage and low current operation: 3 V, 5 mA (max.)
- Specifications guaranteed to a fixed matching circuits for 3 V, 1.9 GHz
- Low noise figure: 1.3 dB (typ.) at 1.9 GHz
- High linear gain: 12.5 dB (typ.) at 1.9 GHz
- High output power: 1 dB compression point = 4.5 dBm (typ.) at 1.9 GHz
- Low distortion: 3rd-order intercept point = 17 dBm (typ.) at 1.9 GHz
- Self-bias circuit configuration with built-in source capacitor
- Package: 4PSOP

#### PACKAGE DIMENSIONS

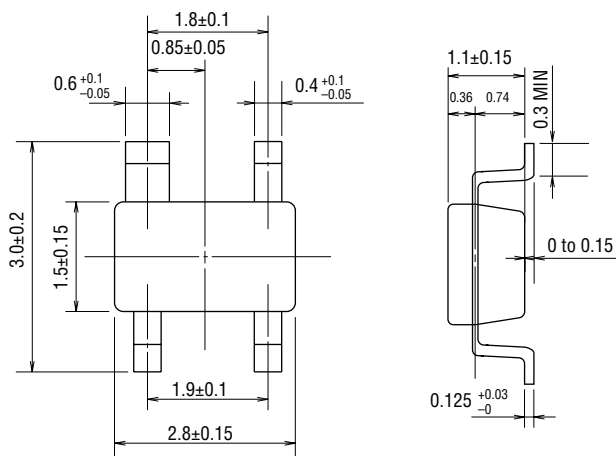

(Unit: mm)

Package material	Epoxy resin
Lead frame material	42 alloy
Pin treatment	Solder plating
Solder plate thickness	5 μm or more

**MARKING**

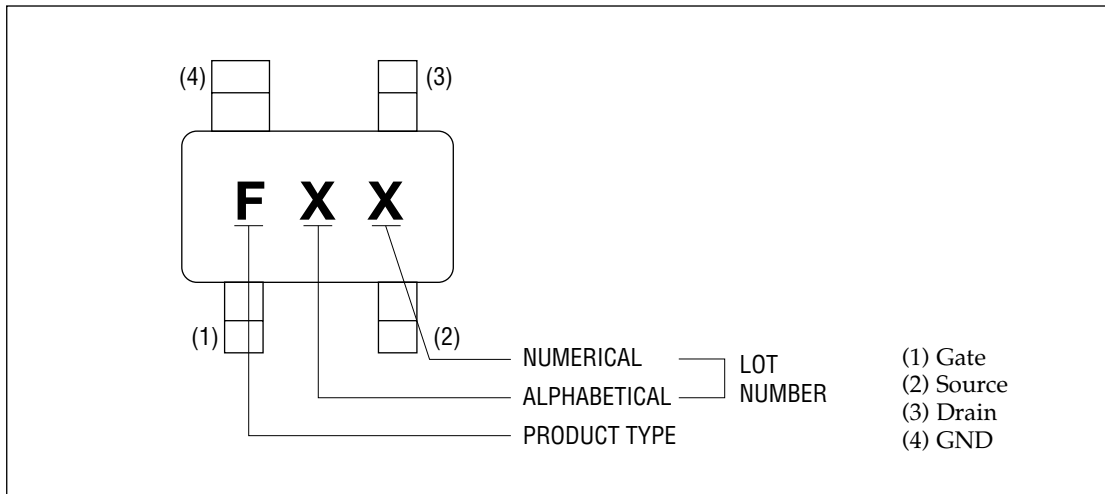

**CIRCUIT**

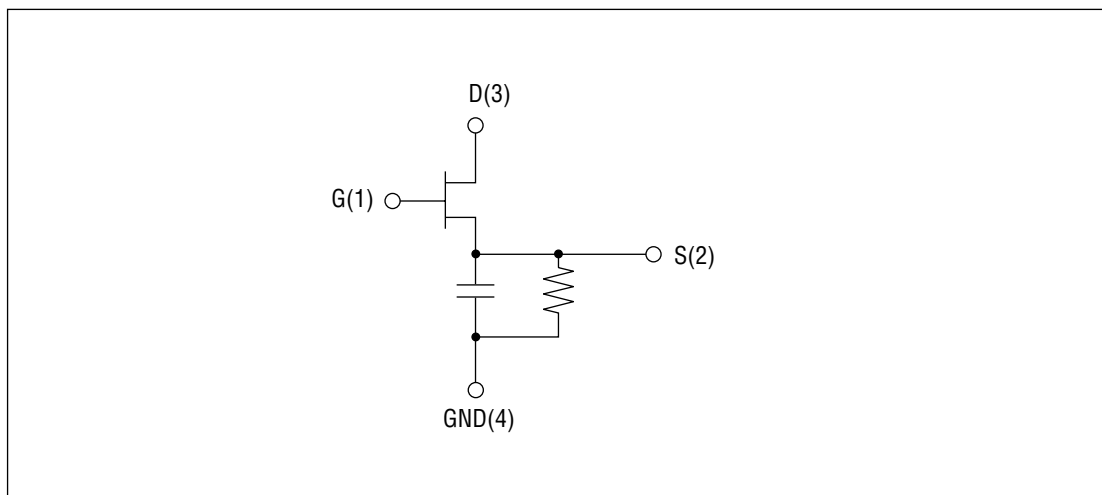

**ABSOLUTE MAXIMUM RATINGS**

Item	Symbol	Condition	Unit	Min.	Max.
Drain-source voltage	$V_{DS}$	$T_a = 25^\circ\text{C}$	V	—	4.0
Gate-source voltage	$V_{GS}$	$T_a = 25^\circ\text{C}$	V	-3.0	0.4
Drain current	$I_{DS}$	$T_a = 25^\circ\text{C}$	mA	—	50
Total power dissipation	$P_{tot}$	$T_a = 25^\circ\text{C}$	mW	—	200
Channel temperature	$T_{ch}$	—	$^\circ\text{C}$	—	150
Storage temperature	$T_{stg}$	—	$^\circ\text{C}$	-45	125

**ELECTRICAL CHARACTERISTICS**

(Ta = 25°C)

Item	Symbol	Condition	Unit	Min.	Typ.	Max.
Gate-source leakage current	$I_{GSS}$	$V_{GS} = -3\text{ V}$	$\mu\text{A}$	—	—	30
Gate-drain leakage current	$I_{GDO}$	$V_{GD} = -6\text{ V}$	$\mu\text{A}$	—	—	30
Drain-source leakage current	$I_{DS(off)}$	$V_{DS} = 3\text{ V}, V_{GS} = -2\text{ V}$	$\mu\text{A}$	—	—	30
Drain current	$I_{DSS}$	$V_{DS} = 3\text{ V}, V_{GS} = 0\text{ V}$	mA	15	25	—
Operating current	$I_D$	(*1), $P_{IN} = -20\text{ dBm}$	mA	—	3.5	5.0
Gate-source cut-off voltage	$V_{GS(off)}$	$V_{DS} = 3\text{ V}, I_{DS} = 100\ \mu\text{A}$	V	-1.4	—	-0.6
Transconductance	$g_m$	$V_{DS} = 3\text{ V}, I_{DS} = 4\text{ mA}$	mS	20	25	—
Noise figure	F	(*1)	dB	—	1.3	2.0
Linear gain	$G_{LIN}$	(*1), $P_{IN} = -20\text{ dBm}$	dB	11.0	12.5	—
Output power	$P_{O1}$	(*1)	dBm	2.0	4.5	—
Third-order intercept point	$IP_3$	(*2), $f_2 = 1.901\text{ GHz}$	dBm	—	17	—

\*1 Self-bias condition:  $V_{DD} = 3\text{ V} \pm 0.3\text{ V}$ ,  $V_G = 0\text{ V}$ ,  $f = 1.9\text{ GHz}$

RF CHARACTERISTICS

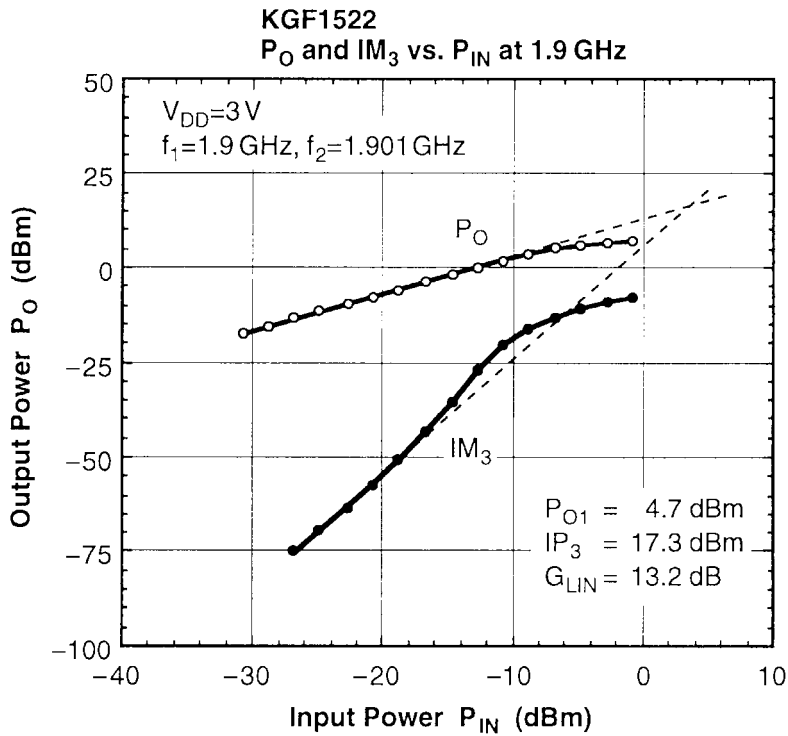
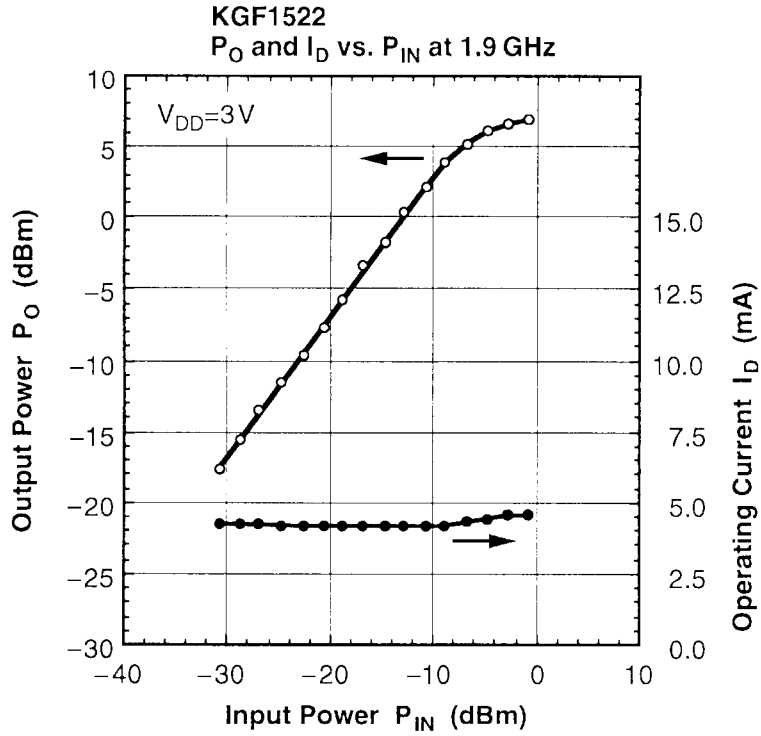

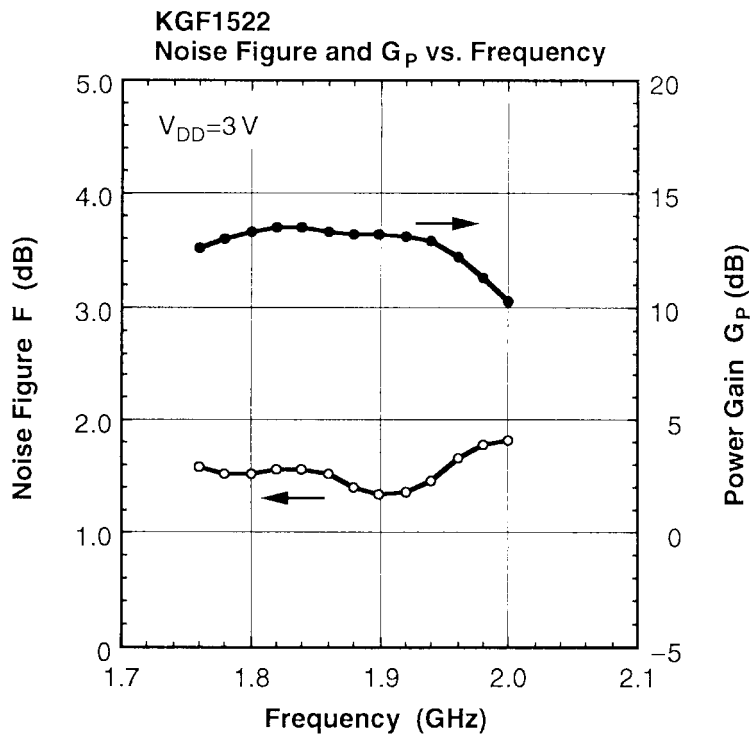

## Typical S Parameters

 $V_{DD} = 3\text{ V}$ ,  $I_D = 4.24\text{ mA}$ 

Freq(MHz)	MAG(S <sub>11</sub> )	ANG(S <sub>11</sub> )	MAG(S <sub>21</sub> )	ANG(S <sub>21</sub> )	MAG(S <sub>12</sub> )	ANG(S <sub>12</sub> )	MAG(S <sub>22</sub> )	ANG(S <sub>22</sub> )
500.0	1.006	-8.82	1.793	177.92	0.011	76.78	0.906	-7.05
600.0	1.002	-10.55	1.805	173.54	0.013	75.78	0.903	-8.02
700.0	0.999	-12.36	1.818	169.53	0.014	74.39	0.900	-9.13
800.0	0.995	-14.14	1.824	166.14	0.015	75.17	0.897	-10.06
900.0	0.991	-15.89	1.821	162.83	0.017	75.08	0.895	-11.09
1000.0	0.985	-17.61	1.827	159.59	0.018	76.01	0.892	-12.05
1100.0	0.980	-19.40	1.826	156.50	0.019	73.48	0.889	-13.13
1200.0	0.974	-21.12	1.931	153.70	0.021	73.99	0.886	-14.05
1300.0	0.967	-22.86	1.832	150.73	0.022	73.53	0.884	-15.12
1400.0	0.960	-24.52	1.829	148.07	0.023	72.19	0.880	-16.05
1500.0	0.952	-26.28	1.833	144.82	0.024	74.66	0.877	-17.02
1600.0	0.944	-27.92	1.839	142.34	0.024	74.26	0.875	-17.94
1700.0	0.934	-29.58	1.832	139.43	0.025	74.34	0.869	-18.76
1800.0	0.925	-31.20	1.834	136.44	0.026	75.49	0.866	-19.81
1900.0	0.915	-32.87	1.837	133.56	0.026	77.61	0.863	-20.67
2000.0	0.904	-34.49	1.842	130.98	0.026	79.54	0.858	-21.59
2100.0	0.893	-36.11	1.835	128.16	0.027	84.41	0.855	-22.52
2200.0	0.880	-37.56	1.828	125.22	0.029	84.29	0.852	-23.35
2300.0	0.868	-38.93	1.821	122.28	0.029	85.27	0.846	-24.15
2400.0	0.856	-40.42	1.827	119.70	0.030	86.94	0.843	-24.87
2500.0	0.843	-41.76	1.807	116.85	0.031	90.44	0.838	-25.57
2600.0	0.828	-43.17	1.810	113.86	0.032	94.40	0.835	-26.44
2700.0	0.815	-44.32	1.786	111.17	0.034	97.95	0.830	-27.12
2800.0	0.801	-45.55	1.793	108.30	0.037	101.31	0.826	-27.83
2900.0	0.788	-46.68	1.767	105.50	0.039	105.31	0.825	-28.51
3000.0	0.773	-47.72	1.767	102.69	0.041	108.19	0.823	-29.01

Typical S Parameters

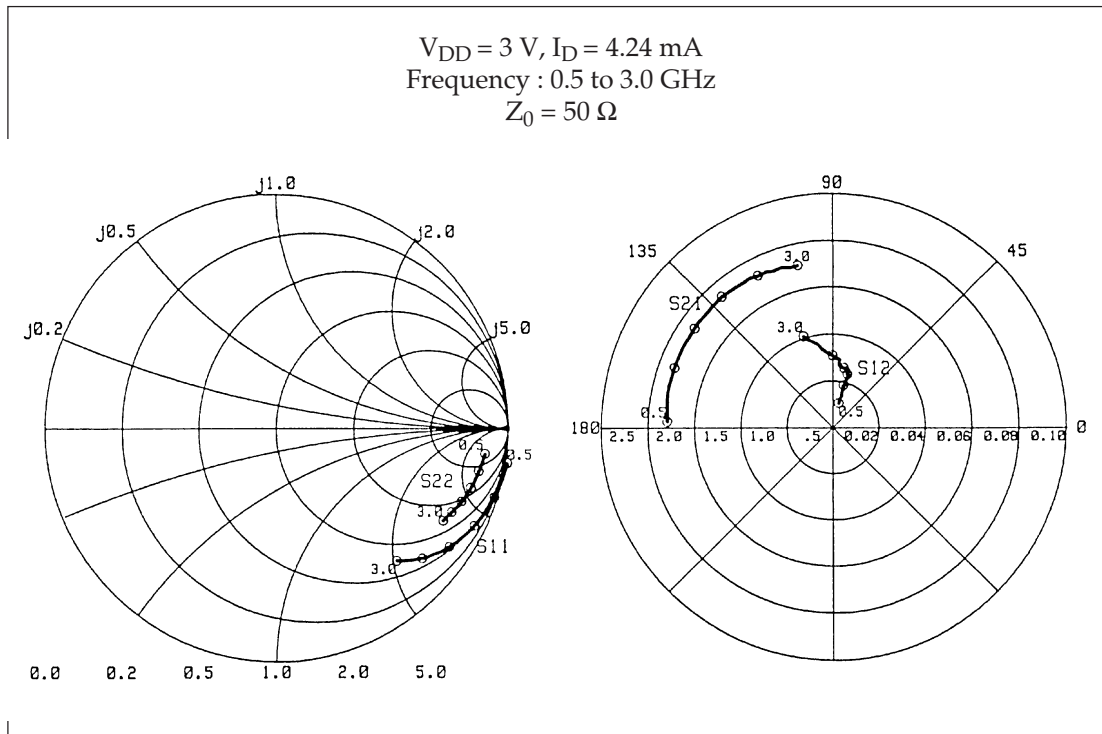

Test Circuit and Bias Configuration for KGF1522 at 1.9 GHz

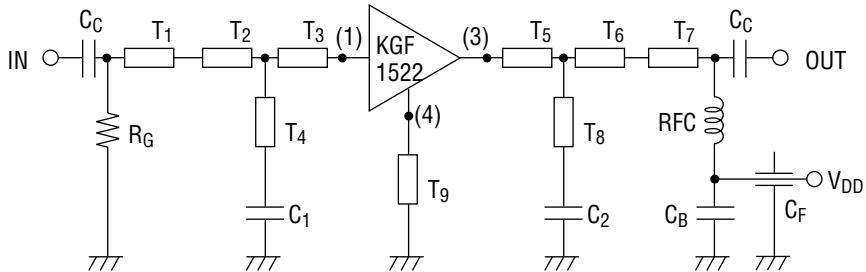

$T_1$ :  $Z_0 = 75 \Omega$ ,  $E = 25 \text{ deg}$        $T_5$ :  $Z_0 = 100 \Omega$ ,  $E = 95 \text{ deg}$   
 $T_2$ :  $Z_0 = 100 \Omega$ ,  $E = 1 \text{ deg}$        $T_6$ :  $Z_0 = 100 \Omega$ ,  $E = 24 \text{ deg}$   
 $T_3$ :  $Z_0 = 100 \Omega$ ,  $E = 78 \text{ deg}$        $T_7$ :  $Z_0 = 75 \Omega$ ,  $E = 23 \text{ deg}$   
 $T_4 = T_8$ :  $Z_0 = 100 \Omega$ ,  $E = 10 \text{ deg}$        $T_9$ :  $Z_0 = 100 \Omega$ ,  $E = 5 \text{ deg}$   
 $C_1 = 1.40 \text{ pF}$ ,  $C_2 = 1.35 \text{ pF}$   
 $C_C(\text{DC Block}) = 1000 \text{ pF}$ ,  $C_B(\text{By-pass}) = 1000 \text{ pF}$ ,  $C_F(\text{Feed through}) = 1000 \text{ pF}$   
 $\text{RFC} = 60 \text{ nH}$ ,  $R_G = 1000 \Omega$