

LEADED CAPACITORS, NETWORKS & HV CAPACITORS

MEDIUM VOLTAGE CAPACITORS

1kV to 6kVDC E.I.A. CLASS II & III

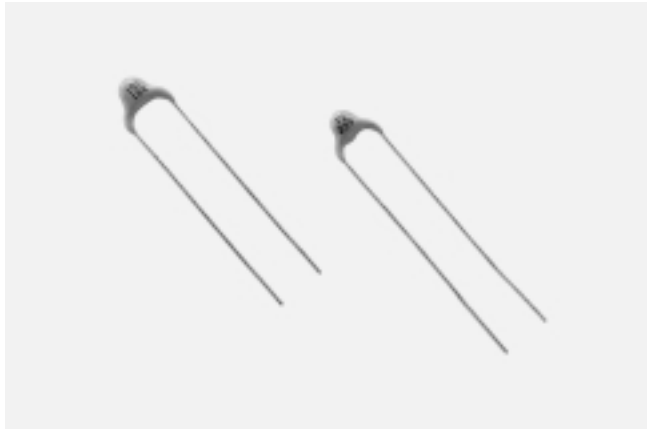

DIMENSIONS: mm

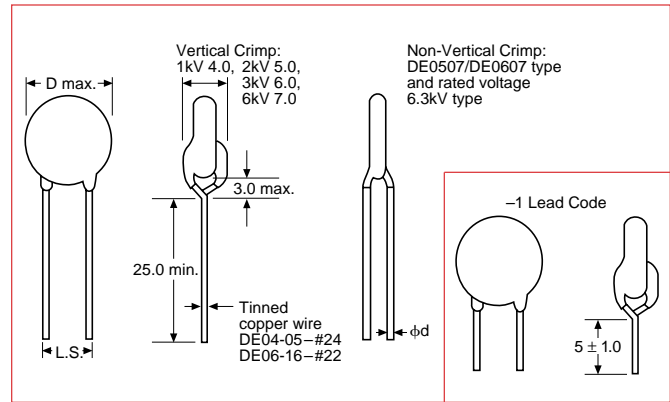

PART NUMBERING SYSTEM

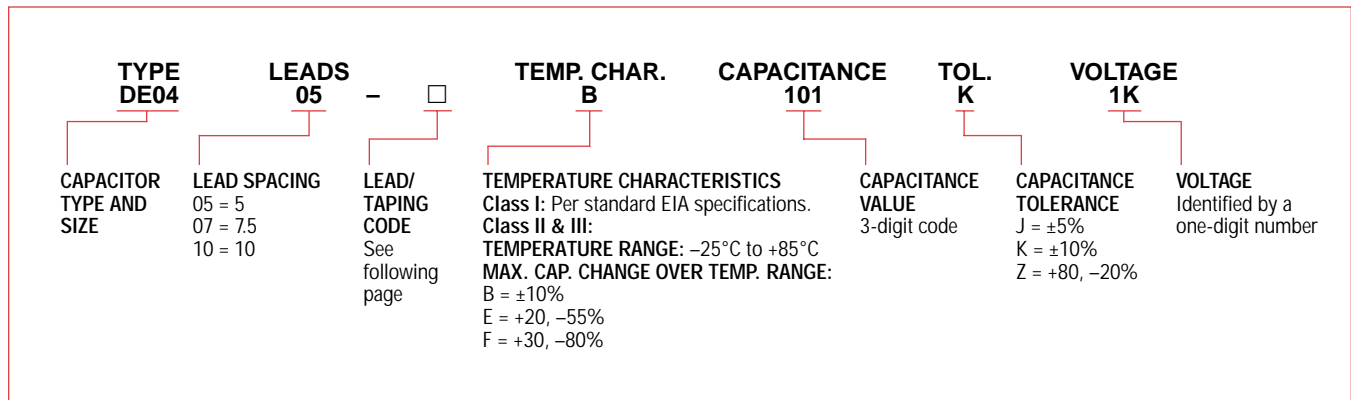

TYPICAL TEMPERATURE CHARACTERISTICS

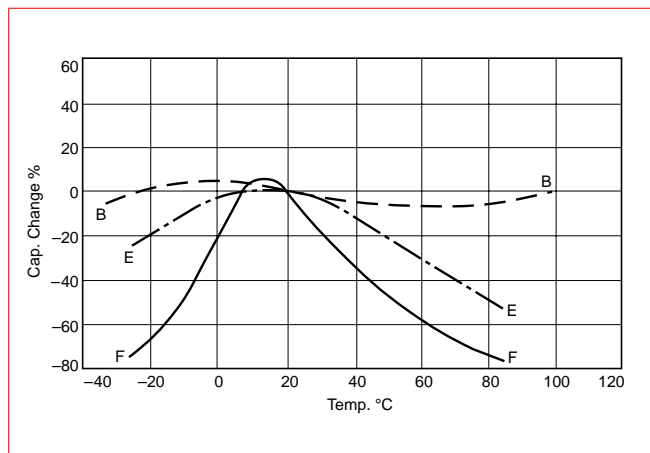

MARKING*

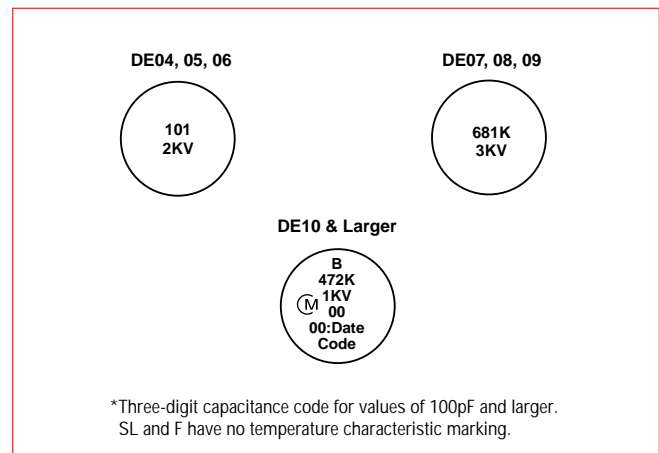







LEADED CAPACITORS, NETWORKS & HV CAPACITORS

MEDIUM VOLTAGE CAPACITORS







1kV to 6kVDC E.I.A. CLASS II & III

B CHARACTERISTIC (Similar to EIA Temperature Characteristic Y5P)







Part Number (□: optional lead code shown at the right)	Nominal Capacitance (pF)	Max. Body Diameter D (mm)	Lead Spacing F (mm)	Rated Voltage (kVDC)	□: Lead Configuration/Lead Code														
					Straight Long	Straight Short	Double Crimp	Taping*1											
																			
DE0405□B101K1K	100	4.5	5.0	1			-69	-979	—	—									
DE0405□B151K1K	150																		
DE0405□B221K1K	220																		
DE0405□B331K1K	330																		
DE0505□B471K1K	470																		
DE0605□B681K1K	680																		
DE0605□B102K1K	1000																		
DE0805□B152K1K	1500																		
DE0905□B222K1K	2200																		
DE1005□B332K1K	3300																		
DE1207□B472K1K	4700	7.5					-610	—	-486	—									
DE1507□B682K1K	6800																		
DE0405□B101K2K	100										4.5	5.0	2	No Code	-1	—	-979	—	—
DE0405□B151K2K	150																		
DE0405□B221K2K	220																		
DE0505□B331K2K	330																		
DE0605□B471K2K	470																		
DE0705□B681K2K	680																		
DE0805□B102K2K	1000																		
DE0905□B152K2K	1500																		
DE1005□B222K2K	2200																		
DE1207□B332K2K	3300																		
DE1507□B472K2K	4700	7.5					-610	—	-486	-477									
DE0507□B101K3K	100																		
DE0507□B151K3K	150																		
DE0507□B221K3K	220																		
DE0607□B331K3K	330																		
DE0707□B471K3K	470																		
DE0807□B681K3K	680																		
DE0907□B102K3K	1000																		
DE1107□B152K3K	1500																		
DE1307□B222K3K	2200																		
DE1507□B332K3K	3300	7.5	3.15				-620	—	-486	—									
DE0507□B101K6K	100																		
DE0507□B151K6K	150																		
DE0507□B221K6K	220																		
DE0607□B331K6K	330																		
DE0707□B471K6K	470																		
DE0807□B681K6K	680																		
DE0907□B102K6K	1000																		
DE1107□B152K6K	1500																		
DE1307□B222K6K	2200																		
DE1507□B332K6K	3300	10.0	6.3	No Code Bulk Only	—	—	—	—	—	—									
DE0910□B101K6K	100																		
DE0910□B151K6K	150																		
DE0910□B221K6K	220																		
DE0910□B331K6K	330																		
DE1010□B471K6K	470																		
DE1110□B681K6K	680																		
DE1310□B102K6K	1000																		

*900 pcs. for KH type

C CHARACTERISTIC (Similar to EIA Temperature Characteristic Y5U)

Part Number (□: optional lead code shown at the right)	Nominal Capacitance (pF)	Max. Body Diameter D (mm)	Lead Spacing F (mm)	Rated Voltage (kVDC)	□: Lead Configuration/Lead Code																							
					Straight Long	Straight Short	Double Crimp	Taping*1																				
																												
DE0505□E102Z1K	1000	5	5.0	1			-69	-979	—	—																		
DE0705□E22Z1K	2200																											
DE0905□E47Z1K	4700																											
DE1307□E103Z1K	10000																											
DE0605□E102Z2K	1000										6	7.5				-620	—	-486	—									
DE0805□E22Z2K	2200																											
DE1105□E47Z2K	4700																											
DE1607□E103Z2K	10000																											
DE0707□E102Z3K	1000																			7	5.0	2	No Code	-1	—	-979	—	—
DE1007□E22Z3K	2200																											
DE1307□E47Z3K	4700																											
DE1110□E102Z6K	1000																											
DE1510□E22Z6K	2200	15	10.0	6.3	Bulk Only	—	—	—	—	—																		
DE0707□E102Z3K	1000																											
DE1007□E22Z3K	2200																											
DE1307□E47Z3K	4700																											
DE1110□E102Z6K	1000																											
DE1510□E22Z6K	2200																											

D CHARACTERISTIC (Similar to EIA Temperature Characteristic Y5V)

Part Number (□: optional lead code shown at the right)	Nominal Capacitance (pF)	Max. Body Diameter D (mm)	Lead Spacing F (mm)	Rated Voltage (kVDC)	□: Lead Configuration/Lead Code																							
					Straight Long	Straight Short	Double Crimp	Taping*1																				
																												
DE0605□F22Z1K	2200	6	5.0	1			-69	-979	—	—																		
DE0705□F47Z1K	4700																											
DE1005□F103Z1K	10000																											
DE0505□F102Z2K	1000										5	7.5				-69	-979	—	—									
DE0705□F22Z2K	2200																											
DE0905□F47Z2K	4700																											
DE1207□F103Z2K	10000																											
DE0505□F102Z2K	1000																			7	5.0	2	No Code	-1	—	-979	—	—
DE0705□F22Z2K	2200																											
DE0905□F47Z2K	4700																											
DE1207□F103Z2K	10000																											
DE0505□F102Z2K	1000	12	7.5				—	—	-486	—																		
DE0705□F22Z2K	2200																											
DE0905□F47Z2K	4700																											
DE1207□F103Z2K	10000																											

All "No Code" bulk versions standard through authorized Murata Electronics Distributors. *See page 96 for specifications.

*900 pcs. for KH type



LEADED CAPACITORS NETWORKS, AND HV CAPACITORS

LEADED CAPACITORS, NETWORKS & HV CAPACITORS

MEDIUM VOLTAGE CAPACITORS

1kV to 6kVDC E.I.A. CLASS II & III-SPECIFICATIONS & TEST METHODS DE Series

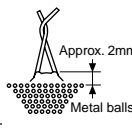

Item	Specification		Test Method																						
	Temperature Compensating	High Dielectric Constant																							
1	Operating Temperature Range	-25 to +85°C	-25 to +85°C	—																					
2	Capacitance	Within the specified tolerance.	Within the specified tolerance.	The capacitance shall be measured at 20°C with 1 ± 0.2kHz (SL: 1 ± 0.2MHz) and 5V(r.m.s.) max.																					
3	Q Dissipation Factor (D.F.)	SL C ≥ 30pF: Q ≥ 1000 C < 30pF: Q ≥ 400 + 20C ¹	B, E D.F. ≤ 2.5% F D.F. ≤ 5.0%	Same condition as capacitance.																					
4	Insulation Resistance (I.R.)	Between lead wires 10000M ohms min.	10000M ohms min.	The insulation resistance shall be measured with 500 ± 50VDC within 60 ± 5 sec. of charging.																					
5	Dielectric Strength	Between lead wires	No failure.	No failure.	The capacitors shall not be damaged when DC voltage of 200% of the rated voltage is applied between the lead wires for 1 to 5 sec. (Charge/discharge current ≤ 50mA)																				
		Body Insulation	No failure.	No failure.	The capacitor is placed in the container with metal balls of diameter 1mm so that each lead wire, short-circuited, is kept approximately 2mm off the balls as shown in the figure, and DC voltage of 1.3kV is applied for 1 to 5 sec. between capacitor lead wires and small metals. (Charge/discharge current ≤ 50mA). 																				
6	Temperature Characteristic	T.C. Temp. Coefficient SL +350 to -1000ppm/°C	T.C. Cap. Change B within ±10% E within $\pm\frac{20}{55}\%$ F within $\pm\frac{30}{80}\%$	The capacitance measurement shall be made at each step specified in table. Capacitance change from the value of step 3 shall not exceed the limit specified. <table border="1" data-bbox="925 693 1461 777"> <thead> <tr> <th>Char.</th> <th>Step</th> <th>1</th> <th>2</th> <th>3</th> <th>4</th> <th>5</th> </tr> </thead> <tbody> <tr> <td>SL</td> <td>—</td> <td>—</td> <td>—</td> <td>20 ± 2°C</td> <td>85 ± 2°C</td> <td>20 ± 2°C</td> </tr> <tr> <td>B, E, F</td> <td>—</td> <td>20 ± 2°C</td> <td>-25 ± 3°C</td> <td>20 ± 2°C</td> <td>85 ± 2°C</td> <td>20 ± 2°C</td> </tr> </tbody> </table> Pre-treatment Capacitor shall be stored at 85 ± 2°C for 1 hour, then placed at room condition ² for 24 ± 2 hours before initial measurements (B, E, F).	Char.	Step	1	2	3	4	5	SL	—	—	—	20 ± 2°C	85 ± 2°C	20 ± 2°C	B, E, F	—	20 ± 2°C	-25 ± 3°C	20 ± 2°C	85 ± 2°C	20 ± 2°C
		Char.	Step		1	2	3	4	5																
SL	—	—	—	20 ± 2°C	85 ± 2°C	20 ± 2°C																			
B, E, F	—	20 ± 2°C	-25 ± 3°C	20 ± 2°C	85 ± 2°C	20 ± 2°C																			
7	Vibration Resistance	Appearance Capacitance Change Q. D.F.	No marked defect. Within the specified tolerance. SL C ≥ 30pF: Q ≥ 1000 C < 30pF: Q ≥ 400 + 20C ¹ B, E D.F. ≤ 2.5% F D.F. ≤ 5.0%	The capacitor shall firmly be soldered to the supporting lead wire and vibration which is 10 to 55Hz in the vibration frequency range, 1.5mm in total amplitude, and about 1 minute in the rate of vibration change from 10Hz to 55Hz and back to 10Hz is applied for a total of 6 hours; 2 hours each in 3 mutually perpendicular directions.																					
8	Soldering Effect	Appearance Capacitance Change	No marked defect. SL within ±2.5%	No marked defect. B within ±5% E within ±15% F within ±20%	The lead wire shall be immersed into the melted solder of 350 ± 10°C (body of φ5 and under: 270 ± 5°C) up to about 1.5 to 2mm from the main body for 3.5 ± 0.5 sec. (body of φ5 and under: 5 ± 0.5 sec.). Pre-treatment Capacitor shall be stored at 85 ± 2°C for 1 hour, then placed at room condition ² for 24 ± 2 hours before initial measurements (B, E, F). Post-treatment Capacitor shall be stored for 1 to 2 hours at room condition ² (SL). Capacitor shall be stored for 24 ± 2 hours at room condition ² (B, E, F).																				
		Dielectric Strength (between lead wires)	Pass the item No. 5.	Pass the item No. 5.																					
9	Humidity (Under Steady State)	Appearance Capacitance Change	No marked defect. SL within ±5%	No marked defect. B within ±10% E within ±20% F within ±30%	Set the capacitor for 500 ⁺²⁴ ₋₀ hours at 40 ± 2°C in 90 to 95% humidity. Pre-treatment Capacitor shall be stored at 85 ± 2°C for 1 hour, then placed at room condition ² for 24 ± 2 hours before initial measurements (B, E, F). Post-treatment Capacitor shall be stored for 1 to 2 hours at room condition ² . Capacitor shall be stored for 24 ± 2 hours at room condition ² .																				
		Q. D.F.	SL C ≥ 30pF: Q ≥ 350 C < 30pF: Q ≥ 275 + ⁵ / ₂ C ¹	B, E D.F. ≤ 5.0% F D.F. ≤ 7.5%																					
		I.R.	1000M ohms min.	1000M ohms min.																					
		10	Humidity Loading	Appearance Capacitance Change		No marked defect. SL within ±7.5%	No marked defect. B within ±10% E within ±20% F within ±30%																		
Q. D.F.	SL C ≥ 30pF: Q ≥ 200 C < 30pF: Q ≥ 100 + ¹⁰ / ₃ C ¹	B, E D.F. ≤ 5.0% F D.F. ≤ 7.5%																							
I.R.	500M ohms min.	500M ohms min.																							
11	Life	Appearance Capacitance Change	No marked defect. SL within ±3%	No marked defect. B within ±10% E within ±20% F within ±30%	Apply a DC voltage of 150% of the rated voltage for 1000 ⁺⁴⁸ ₋₀ hours at 85 ± 2°C. (Charge/discharge current ≤ 50mA). Pre-treatment Capacitor shall be stored at 85 ± 2°C for 1 hour, then placed at room condition ² for 24 ± 2 hours before initial measurements (B, E, F). Post-treatment Capacitor shall be stored for 1 to 2 hours at room condition ² (SL). Capacitor shall be stored at 85 ± 2°C for 1 hour, then placed at room condition ² for 24 ± 2 hours (B, E, F).																				
		Q. D.F.	SL C ≥ 30pF: Q ≥ 350 C < 30pF: Q ≥ 275 + ⁵ / ₂ C ¹	B, E D.F. ≤ 4.0% F D.F. ≤ 7.5%																					
		I.R.	2000M ohms min.	2000M ohms min.																					
		12	Strength of Lead	Pull		Lead wire shall not cut off. Capacitor shall not be broken.	As in figure, fix the body of capacitor, apply a tensile weight gradually to each lead wire in the radial direction of capacitor up to 10N (1.0kgf) 5N (0.51kgf) for lead diameter φ0.5, and keep it for 10 ± 1 sec.  Each lead wire shall be subjected to 5N (0.51kgf) 2.5N (0.25kgf) for lead diameter φ0.5 weight and then a 90° bend, at the point of egress, in one direction, return to original position, and then a 90° bend in the opposite direction at the rate of one bend in 2 to 3 seconds.																		
Bending																									
13	Solderability of Leads	Lead wire shall be soldered with uniform coating on the axial direction over ³ / ₄ of the circumferential direction.		The lead wire of a capacitor shall be dipped into a methanol solution of 25wt% rosin and then into molten solder of 235 ± 5°C for 2 ± 0.5 seconds. In both cases the depth of dipping is up to about 1.5 to 2mm from the root of lead wires.																					

LEADED CAPACITORS, NETWORKS & HV CAPACITORS

HIGH TEMPERATURE CAPACITORS

250V to 3kVDC E.I.A. CLASS I & II



DIMENSIONS: mm

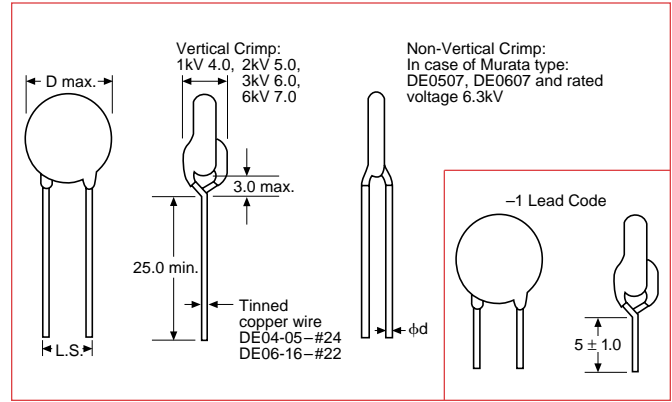

LEADED CAPACITORS NETWORKS, AND HV CAPACITORS

PART NUMBERING SYSTEM

TYPE DE04	LEADS 05	-	TEMP. CHAR. SL	CAPACITANCE 120	TOL. J	VOLTAGE 1K									
CAPACITOR TYPE AND SIZE	LEAD SPACING 05 = 5 07 = 7.5 10 = 10	LEAD/TAPING CODE See following pages	TEMPERATURE CHARACTERISTICS -25°C to +125°C MAX. CAP. CHANGE OVER TEMP. RANGE SL = +350-1000ppm/°C	CAPACITANCE VALUE Expressed in picofarads and identified by a three-digit number. First two digits represent significant figures. Last digit specifies the number of zeros to follow.	CAPACITANCE TOLERANCE D = ±0.5pF J = ±5% (SL only) K = ±10%	VOLTAGE Identified by a one, two or three digit number.									
					<table border="1"> <tr> <td></td> <td>-25°C to +85°C</td> <td>+85°C to +125°C</td> </tr> <tr> <td>R =</td> <td>±15%</td> <td>+15, -30%</td> </tr> <tr> <td>C =</td> <td>±20%</td> <td>+15, -30%</td> </tr> </table>			-25°C to +85°C	+85°C to +125°C	R =	±15%	+15, -30%	C =	±20%	+15, -30%
	-25°C to +85°C	+85°C to +125°C													
R =	±15%	+15, -30%													
C =	±20%	+15, -30%													

TYPICAL TEMPERATURE VS. CAPACITANCE CHANGE

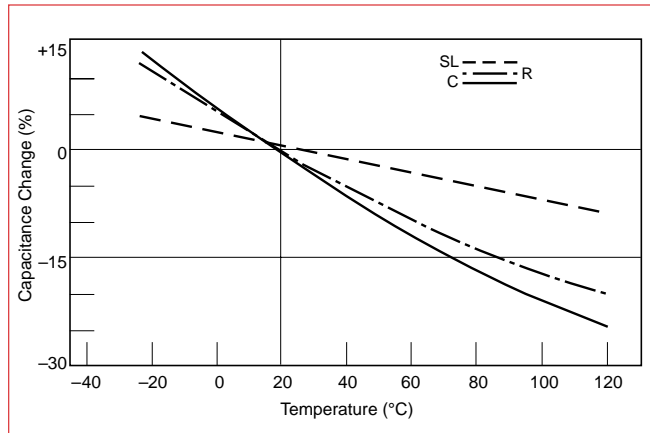

MARKING*

DE04, 05, 06

DE07, 08, 09

DE10 & Larger

*Working Voltage not marked for 500V. Three-digit capacitance code for values 100pF and higher.

TYPICAL AC/DC BREAKDOWN VOLTAGE

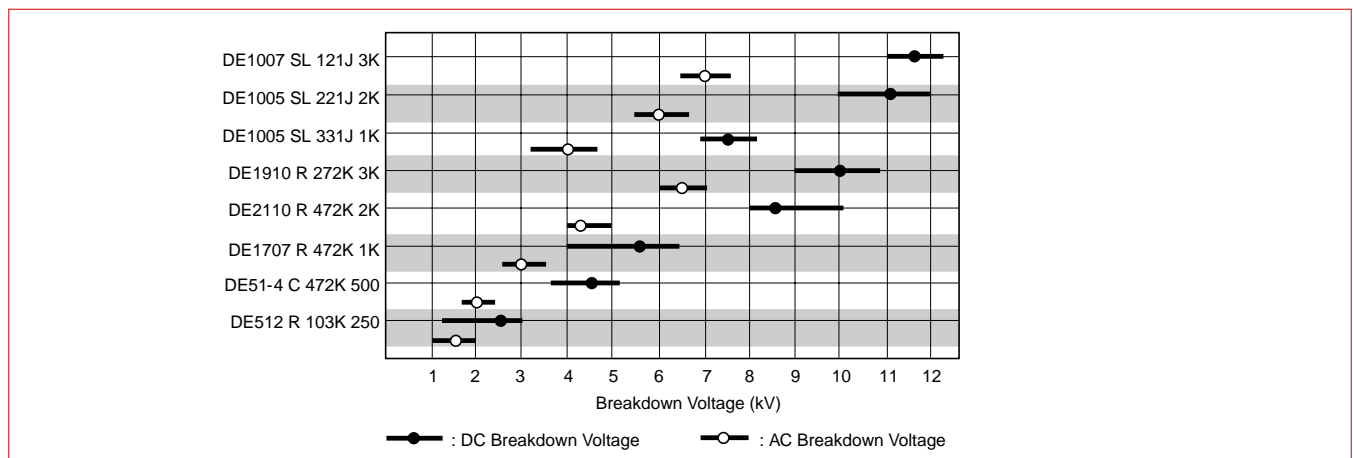







LEADED CAPACITORS, NETWORKS & HV CAPACITORS

HIGH TEMPERATURE CAPACITORS



250V to 3kVDC E.I.A. CLASS I & II

SL CHARACTERISTIC

Part Number (□: optional lead code shown at the right)	Nominal Capacitance (pF)	Max. Body Diameter D (mm)	Lead Spacing F (mm)	Rated Voltage (kVDC)	□: Lead Configuration/Lead Code					
					Straight Long	Straight Short	Double Crimp	Taping**		
								 Lead Spacing F: 5.0 Pitch of Component P: 12.7	 Lead Spacing F: 7.5 Pitch of Component P: 15.0	 Lead Spacing F: 7.5 Pitch of Component P: 30.0
DE0405□SL100D1K	10	4.5	5.0	1	No Code	-	-69	-979	-	-
DE0405□SL120J1K	12									
DE0405□SL150J1K	15									
DE0405□SL180J1K	18									
DE0405□SL220J1K	22									
DE0405□SL270J1K	27									
DE0405□SL330J1K	33									
DE0405□SL390J1K	39									
DE0405□SL470J1K	47									
DE0505□SL560J1K	56									
DE0505□SL680J1K	68									
DE0605□SL820J1K	82									
DE0605□SL101J1K	100									
DE0605□SL121J1K	120									
DE0705□SL151J1K	150									
DE0705□SL181J1K	180									
DE0805□SL221J1K	220									
DE0905□SL271J1K	270									
DE1005□SL331J1K	330									
DE1005□SL391J1K	390									
DE1105□SL471J1K	470									
DE1207□SL561J1K	560									
DE0405□SL100D2K	10	4.5	5.0	2	No Code	-	-69	-979	-	-
DE0405□SL120J2K	12									
DE0405□SL150J2K	15									
DE0405□SL180J2K	18									
DE0405□SL220J2K	22									
DE0405□SL270J2K	27									
DE0405□SL330J2K	33									
DE0505□SL390J2K	39									
DE0605□SL470J2K	47									
DE0605□SL560J2K	56									
DE0605□SL680J2K	68									
DE0705□SL820J2K	82									
DE0705□SL101J2K	100									
DE0805□SL121J2K	120									
DE0805□SL151J2K	150									
DE0905□SL181J2K	180									
DE1005□SL221J2K	220									
DE1107□SL271J2K	270									
DE1207□SL331J2K	330									
DE1307□SL391J2K	390									
DE1407□SL471J2K	470									
DE1507□SL561J2K	560									
DE0507□SL100D3K	10	5	7.5	3.15	-	-	-	-	-	-
DE0507□SL120J3K	12									
DE0507□SL150J3K	15									
DE0507□SL180J3K	18									
DE0507□SL220J3K	22									
DE0607□SL270J3K	27									
DE0607□SL330J3K	33									
DE0607□SL390J3K	39									
DE0707□SL470J3K	47									
DE0707□SL560J3K	56									
DE0807□SL680J3K	68									
DE0807□SL820J3K	82									
DE0907□SL101J3K	100									
DE1007□SL121J3K	120									
DE1107□SL151J3K	150									
DE1107□SL181J3K	180									
DE1207□SL221J3K	220									
DE1407□SL271J3K	270									
DE1507□SL331J3K	330									
DE1607□SL391J3K	390									

*900 pcs. for KH type

R CHARACTERISTIC (250V)

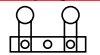

Part Number (□: optional lead code shown at the right)	Nominal Capacitance (pF)	Max. Body Diameter D (mm)	Lead Spacing F (mm)	Rated Voltage (VDC)	□: Lead Configuration/Lead Code			
					Straight Long	Straight Short	Double Crimp	Taping**
								 Lead Spacing F: 5.0 Pitch of Component P: 12.7
DE506□R221K250	220	6	5.0	250	No Code	-1	-69	-979
DE506□R331K250	330							
DE506□R471K250	470							
DE506□R681K250	680							
DE506□R102K250	1000							
DE507□R152K250	1500							
DE508□R222K250	2200							
DE509□R332K250	3300							
DE510□R472K250	4700							
DE512□R682K250	6800							
DE512□R103K250	10000							

LEADED CAPACITORS, NETWORKS & HV CAPACITORS

HIGH TEMPERATURE CAPACITORS

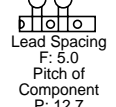
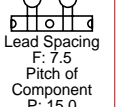
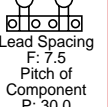

250V to 3kVDC E.I.A. CLASS I & II

R CHARACTERISTIC (1 to 3.15kV)

Part Number (□: optional lead code shown at the right)	Nominal Capacitance (pF)	Max. Body Diameter D (mm)	Lead Spacing F (mm)	Rated Voltage (kVDC)	□: Lead Configuration/Lead Code					
					Straight Long	Straight Short	Double Crimp	Taping**		
										
DE0705□R221K1K DE0705□R331K1K DE0705□R471K1K DE0805□R681K1K DE0905□R102K1K DE1105□R152K1K DE1310□R222K1K DE1510□R332K1K DE1710□R472K1K	220 330 470 680 1000 1500 2200 3300 4700	7 8 9 11 13 15 17	5.0 10.0	1			-69	-979	—	—
DE0707□R221K2K DE0707□R271K2K DE0807□R331K2K DE0807□R391K2K DE0907□R471K2K DE0907□R561K2K DE1007□R681K2K DE1107□R821K2K DE1207□R102K2K DE1207□R122K2K DE1207□R152K2K DE1407□R182K2K DE1507□R222K2K DE1707□R272K2K DE1910□R332K2K DE2010□R392K2K DE2110□R472K2K	220 270 330 390 470 560 680 820 1000 1200 1500 1800 2200 2700 3300 3900 4700	7 8 9 10 11 14 15 17 19 20 21	7.5 10.0	2	No Code	-1	-620	—	-486	-477
DE0707□R151K3K DE0707□R181K3K DE0707□R221K3K DE0707□R271K3K DE0807□R331K3K DE0907□R391K3K DE1007□R471K3K DE1007□R561K3K DE1107□R681K3K DE1207□R821K3K DE1307□R102K3K DE1407□R122K3K DE1507□R152K3K DE1607□R182K3K DE1707□R222K3K DE1910□R272K3K	150 180 220 270 330 390 470 560 680 820 1000 1200 1500 1800 2200 2700	7 8 9 10 11 12 13 14 15 16 17 19	7.5 10.0	3.15			—	—	-486	-477

*900 pcs. for KH type

C CHARACTERISTIC

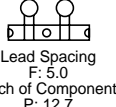
Part Number (□: optional lead code shown at the right)	Nominal Capacitance (pF)	Max. Body Diameter D (mm)	Lead Spacing F (mm)	Rated Voltage (VDC)	□: Lead Configuration/Lead Code			
					Straight Long	Straight Short	Double Crimp	Taping**
								
DE50-6□C331K500 DE50-6□C471K500 DE50-7□C681K500 DE50-8□C102K500 DE50-9□C152K500 DE51-0□C222K500 DE51-2□C332K500 DE51-4□C472K500	330 470 680 1000 1500 2200 3300 4700	6 7 8 9 10 12 14	5.0 10.0	500	No Code	-1	-69	-979
							-610	—

*See page 96 for specifications.

*900 pcs. for KH type

LEADED CAPACITORS, NETWORKS, AND HV CAPACITORS

Item		Specification		Test Method																																							
1	Operating Temperature Range	-25 to +125°C		—																																							
2	Capacitance	Within the specified tolerance.		The capacitance shall be measured at 20°C with 1 ± 0.2kHz (SL: 1 ± 0.2MHz) and 5V(r.m.s.) max.																																							
3	Q Dissipation Factor (D.F.)	$C \geq 30\text{pF}$: $Q \geq 1000$ $C < 30\text{pF}$: $Q \geq 400 + 20C^1$ (SL)	D.F. $\leq 0.4\%$ (R [250V]) D.F. $\leq 0.2\%$ (R [1 to 3.15kV]) D.F. $\leq 0.3\%$ (C)	Same condition as capacitance.																																							
4	Insulation Resistance (I.R.)	Between lead wires	10000M ohms min. (SL, R [1 to 3.15kV], C)	1000M ohms min. (R [250V])	The insulation resistance shall be measured with 500 ± 50VDC (R [250V]: 100 ± 15V) within 60 ± 5 sec. of charging.																																						
5	Dielectric Strength	Between lead wires	No failure.		The capacitors shall not be damaged when DC voltage of 200% of the rated voltage (in case of rated voltage: 1 to 3.15kV) or DC voltage of 250% of the rated voltage (in case of rated voltage: 250V, 500V) is applied between the lead wires for 1 to 5 sec. (Charge/discharge current $\leq 50\text{mA}$) The capacitor is placed in the container with metal balls of diameter 1mm so that each lead wire, short-circuited, is kept approximately 2mm off the balls as shown in the figure, and AC voltage of 1250V is applied for 1 to 5 sec. between capacitor lead wires and small metals. (Charge/discharge current $\leq 50\text{mA}$)																																						
		Body Insulation	No failure.																																								
6	Temperature Characteristic	<table border="1"> <thead> <tr> <th>T.C.</th> <th>Temp. Coefficient</th> <th>Temp. Range</th> <th colspan="2">Cap. Change</th> </tr> <tr> <th>SL</th> <td>+350 to -1000ppm/°C</td> <td></td> <th>C</th> <th>R</th> </tr> </thead> <tbody> <tr> <td></td> <td></td> <td>-25 to +85°C</td> <td>within ±20%</td> <td>within ±15%</td> </tr> <tr> <td></td> <td></td> <td>+85 to +125°C</td> <td colspan="2">within $\pm 15\%$</td> </tr> </tbody> </table>		T.C.	Temp. Coefficient	Temp. Range	Cap. Change		SL	+350 to -1000ppm/°C		C	R			-25 to +85°C	within ±20%	within ±15%			+85 to +125°C	within $\pm 15\%$		<table border="1"> <thead> <tr> <th>Char. Step</th> <th>1</th> <th>2</th> <th>3</th> <th>4</th> <th>5</th> </tr> </thead> <tbody> <tr> <td>SL</td> <td>—</td> <td>—</td> <td>20 ± 2°C</td> <td>85 ± 2°C/125 ± 2°C</td> <td>20 ± 2°C</td> </tr> <tr> <td>C, R</td> <td>20 ± 2°C</td> <td>-25 ± 3°C</td> <td>20 ± 2°C</td> <td>85 ± 2°C/125 ± 2°C</td> <td>20 ± 2°C</td> </tr> </tbody> </table>		Char. Step	1	2	3	4	5	SL	—	—	20 ± 2°C	85 ± 2°C/125 ± 2°C	20 ± 2°C	C, R	20 ± 2°C	-25 ± 3°C	20 ± 2°C	85 ± 2°C/125 ± 2°C	20 ± 2°C
		T.C.	Temp. Coefficient	Temp. Range	Cap. Change																																						
SL	+350 to -1000ppm/°C		C	R																																							
		-25 to +85°C	within ±20%	within ±15%																																							
		+85 to +125°C	within $\pm 15\%$																																								
Char. Step	1	2	3	4	5																																						
SL	—	—	20 ± 2°C	85 ± 2°C/125 ± 2°C	20 ± 2°C																																						
C, R	20 ± 2°C	-25 ± 3°C	20 ± 2°C	85 ± 2°C/125 ± 2°C	20 ± 2°C																																						
The capacitance measurement shall be made at each step specified in table. Capacitance change from the value of step 3 shall not exceed the limit specified. Pre-treatment: Capacitor shall be stored at 125 ± 3°C for 1 hour, then placed at room condition ² for 24 ± 2 hours before initial measurements (R, C).																																											
7	Temperature Cycling	Appearance	No marked defect.		The capacitor shall be introduced into the test chamber, and shall be exposed to the temperature conditions of steps 1 to 4 as shown in table at 5 cycles. <table border="1"> <thead> <tr> <th>Step</th> <th>Temp. (°C)</th> <th>Time (min.)</th> <th>Step</th> <th>Temp. (°C)</th> <th>Time (min.)</th> </tr> </thead> <tbody> <tr> <td>1</td> <td>-25 ± 3</td> <td>30 ± 3</td> <td>3</td> <td>+125 ± 3</td> <td>30 ± 3</td> </tr> <tr> <td>2</td> <td>room temp.</td> <td>3 max.</td> <td>4</td> <td>room temp.</td> <td>3 max.</td> </tr> </tbody> </table>	Step	Temp. (°C)	Time (min.)	Step	Temp. (°C)	Time (min.)	1	-25 ± 3	30 ± 3	3	+125 ± 3	30 ± 3	2	room temp.	3 max.	4	room temp.	3 max.																				
		Step	Temp. (°C)	Time (min.)		Step	Temp. (°C)	Time (min.)																																			
		1	-25 ± 3	30 ± 3		3	+125 ± 3	30 ± 3																																			
		2	room temp.	3 max.		4	room temp.	3 max.																																			
Capacitance Change	Within ±5% (SL)		Within ±10% (R, C)																																								
Q	$C \geq 30\text{pF}$: $Q \geq 350$		D.F. $\leq 0.4\%$ (R, C)																																								
D.F.	$C < 30\text{pF}$: $Q \geq 275 + \frac{5}{2}C^1$ (SL)																																										
I.R.	1000M ohms min.																																										
Dielectric Strength (between lead wires)	Pass the item No. 5.																																										
8	Vibration Resistance	Appearance	No marked defect.		The capacitor shall firmly be soldered to the supporting lead wire and vibration which is 10 to 55Hz in the vibration frequency range, 1.5mm in total amplitude, and about 1 minute in the rate of vibration change from 10Hz to 55Hz and back to 10Hz is applied for a total of 6 hours; 2 hours each in 3 mutually perpendicular directions.																																						
		Capacitance Change	Within the specified tolerance.																																								
		Q	$C \geq 30\text{pF}$: $Q \geq 1000$																																								
		D.F.	$C < 30\text{pF}$: $Q \geq 400 + 20C^1$ (SL)																																								
9	Soldering Effect	Appearance	No marked defect.		The lead wire shall be immersed into the melted solder of 350 ± 10°C up to about 1.5 to 2mm from the main body for 3.5 ± 0.5 sec. and the specified items shall be measured after leaving for 24 ± 2 hours. Pre-treatment: Capacitor shall be stored at 125 ± 3°C for 1 hour, then placed at room condition ² for 24 ± 2 hours before initial measurements (R, C). Post-treatment: Capacitor shall be stored for 1 to 2 hours at room condition ² (SL). Capacitor shall be stored for 24 ± 2 hours at room condition ² (R, C). Measurement Order: Dielectric Strength → Pre-treatment → Capacitance → Soldering Effect test → Post-treatment → Capacitance, Dielectric Strength (R [250V]).																																						
		Capacitance Change	Within ±2.5% (SL)																																								
		Dielectric Strength (between lead wires)	Pass the item No. 5.																																								
		I.R.	1000M ohms min.																																								
10	Humidity (Under Steady State)	Appearance	No marked defect.		Set the capacitor for 500 ^{±24} hours at 40 ± 2°C in 90 to 95% humidity. Pre-treatment: Capacitor shall be stored at 125 ± 3°C for 1 hour, then placed at room condition ² for 24 ± 2 hours before initial measurements (R, C). Post-treatment: Capacitor shall be stored for 1 to 2 hours at room condition ² (SL). Capacitor shall be stored for 24 ± 2 hours at room condition ² (R, C). Measurement Order: I.R. → Pre-treatment → Capacitance, D.F. → Humidity test → Post-treatment → Capacitance, D.F., I.R. (R [250V]). (Charge/discharge current $\leq 50\text{mA}$).																																						
		Capacitance Change	Within ±5% (SL)																																								
		Q	$C \geq 30\text{pF}$: $Q \geq 350$																																								
		D.F.	$C < 30\text{pF}$: $Q \geq 275 + \frac{5}{2}C^1$ (SL)																																								
11	Life	Appearance	No marked defect.		Apply a DC voltage of 200% of the rated voltage (in case of rated voltage: 250V, 500V) or DC voltage of 150% of the rated voltage (in case of rated voltage: 1 to 3.15kV) for 1000 ^{±8} hours at 125 ± 2°C. Pre-treatment: Capacitor shall be stored at 125 ± 3°C for 1 hour, then placed at room condition ² for 24 ± 2 hours before initial measurements (R, C). Post-treatment: Capacitor shall be stored for 1 to 2 hours at room condition ² (SL). Capacitor shall be stored at 125 ± 3°C for 1 hour, then placed at room condition ² for 24 ± 2 hours (R, C). Measurement Order: I.R. → Pre-treatment → Capacitance, D.F. → Life test → I.R. ³ → Post-treatment → Capacitance, D.F. (R [250V]). (Charge/discharge current $\leq 50\text{mA}$).																																						
		Capacitance Change	Within ±3% (SL)																																								
		Q	$C \geq 30\text{pF}$: $Q \geq 350$																																								
		D.F.	$C < 30\text{pF}$: $Q \geq 275 + \frac{5}{2}C^1$ (SL)																																								
12	Strength of Lead	I.R.	2000M ohms min. (SL, R [1 to 3.15kV], C)		As in figure, fix the body of capacitor, apply a tensile weight gradually to each lead wire in the radial direction of capacitor up to 10N (1.0kgf) and keep it for 10 ± 1 sec. Each lead wire shall be subjected to 5N (0.51kgf) weight and then a 90° bend, at the point of egress, in one direction, return to original position, and then a 90° bend in the opposite direction at the rate of one bend in 2 to 3 seconds.																																						
		Capacitance Change	Within ±10% (R, C)																																								
		Q	$C \geq 30\text{pF}$: $Q \geq 350$																																								
		D.F.	$C < 30\text{pF}$: $Q \geq 275 + \frac{5}{2}C^1$ (SL)																																								
13	Solderability of Leads	I.R.	1000M ohms min. (R [250V])		The lead wire of a capacitor shall be dipped into a methanol solution of 25wt% rosin and then into molten solder of 235 ± 5°C for 2 ± 0.5 seconds. In both cases the depth of dipping is up to about 1.5 to 2mm from the root of lead wires.																																						
		Capacitance Change	Within ±10% (R, C)																																								

¹C¹ expresses nominal capacitance value (pF). ²room condition² temperature: 15 to 35°C; humidity: 45 to 75%; atmospheric pressure: 860 to 1060hPa.

³The measurement of I.R. will be held in 12 to 24 hours after Life test.