

INTERNATIONAL RECTIFIER

REPETITIVE AVALANCHE RATED AND dv/dt RATED

HEXFET[®] TRANSISTOR

IRFM440

2N7222

JANTX2N7222

JANTXV2N7222

(REF: MIL-S-19500/596)

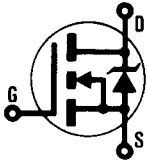

N-CHANNEL

500 Volt, 0.85 Ohm HEXFET

The HEXFET[®] technology is the key to International Rectifier's advanced line of power MOSFET transistors. The efficient geometry design achieves very low on-state resistance combined with high transconductance.

The HEXFET transistors also feature all of the well established advantages of MOSFETs such as voltage control, very fast switching, ease of paralleling and temperature stability of the electrical parameters.

They are well suited for applications such as switching power supplies and virtually any application where military and/or high reliability is required.

Product Summary

Part Number	V_{DSS}	$R_{DS(on)}$	I_D
IRFM440	500V	0.85Ω	8.0A

FEATURES:

- Repetitive Avalanche Rating
- Isolated and Hermetically Sealed
- Alternative to TO-3 Package
- Simple Drive Requirements
- Ease of Paralleling
- Ceramic Eyelets

CASE STYLE AND DIMENSIONS

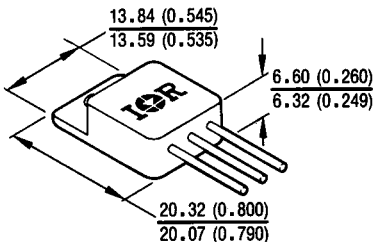

CAUTION

BERYLLIA WARNING PER MIL-S-19500
SEE PAGE I-356

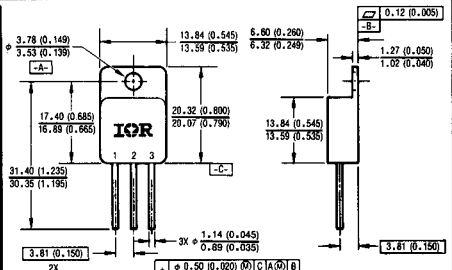

LEGEND

- 1 DRAIN
- 2 SOURCE
- 3 GATE

NOTES:

- 1 DIMENSIONING & TOLERANCING PER ANSI Y14.5M - 1982
- 2 ALL DIMENSIONS ARE SHOWN IN MILLIMETERS (INCHES)

Conforms to JEDEC Outline TO-254AA*
Dimensions in Millimeters and (Inches)

*For leadform configurations see page I-356, fig. 15

Absolute Maximum Ratings

Parameter		IRFM440, JANTXV-, JANTX-, 2N7222	Units
I_D @ $V_{GS} = 10V$, $T_C = 25^\circ C$	Continuous Drain Current	8.0	A
I_D @ $V_{GS} = 10V$, $T_C = 100^\circ C$	Continuous Drain Current	5.0	
I_{DM}	Pulsed Drain Current ①	32	
P_D @ $T_C = 25^\circ C$	Max. Power Dissipation	125	W
	Linear Derating Factor	1.0	W/K ⑤
V_{GS}	Gate-to-Source Voltage	± 20	V
E_{AS}	Single Pulse Avalanche Energy ②	700 (See Fig. 12)	mJ
I_{AR}	Avalanche Current ①	8.0 (See E_{AR})	A
E_{AR}	Repetitive Avalanche Energy ①	12.5 (See Fig. 13)	mJ
dv/dt	Peak Diode Recovery dv/dt ③	3.5 (See Fig. 13)	V/ns
T_J T_{STG}	Operating Junction Storage Temperature Range	-55 to 150	°C
	Lead Temperature	300 (0.083 in. (1.6 mm) from case for 10s)	
	Weight	9.3 (typical)	g

Electrical Characteristics @ $T_J = 25^\circ C$ (Unless Otherwise Specified)

Parameter		Min.	Typ.	Max.	Units	Test Conditions
BV_{DSS}	Drain-to-Source Breakdown Voltage	500	—	—	V	$V_{GS} = 0V$, $I_D = 1.0$ mA
$\Delta BV_{DSS}/\Delta T_J$	Temperature Coefficient of Breakdown Voltage	—	0.78	—	V/°C	Reference to $25^\circ C$, $I_D = 1.0$ mA
$R_{DS(on)}$	Static Drain-to-Source On-State Resistance	—	—	0.85	Ω	$V_{GS} = 10V$, $I_D = 5.0A$ ④
		—	—	0.95		$V_{GS} = 10V$, $I_D = 8.0A$
$V_{GS(th)}$	Gate Threshold Voltage	2.0	—	4.0	V	$V_{DS} = V_{GS}$, $I_D = 250$ μA
g_{fs}	Forward Transconductance	4.7	—	—	S (f)	$V_{DS} \geq 15V$, $I_{DS} = 5.0A$ ④
I_{DSS}	Zero Gate Voltage Drain Current	—	—	25	μA	$V_{DS} = 0.8 \times$ Max. Rating, $V_{GS} = 0V$
		—	—	250		$V_{DS} = 0.8 \times$ Max. Rating $V_{GS} = 0V$, $T_J = 125^\circ C$
I_{GSS}	Gate-to-Source Leakage Forward	—	—	100	nA	$V_{GS} = 20V$
I_{GSS}	Gate-to-Source Leakage Reverse	—	—	-100	nA	$V_{GS} = -20V$
Q_g	Total Gate Charge	27.3	—	68.5	nC	$V_{GS} = 10V$, $I_D = 8.0A$
Q_{gs}	Gate-to-Source Charge	2.0	—	12.5		$V_{DS} = 0.5 \times$ Max. Rating
Q_{gd}	Gate-to-Drain ("Miller") Charge	11.1	—	42.4		See Fig. 6 and 14
$t_{d(on)}$	Turn-On Delay Time	—	—	21	ns	$V_{DD} = 250V$, $I_D = 5.0A$, $R_G = 9.1\Omega$ See Fig. 11
t_r	Rise Time	—	—	73		
$t_{d(off)}$	Turn-Off Delay Time	—	—	72		
t_f	Fall Time	—	—	51		
L_D	Internal Drain Inductance	—	8.7	—	nH	Measured from the drain lead, 6 mm (0.25 in.) from package to center of die. Modified MOSFET symbol showing the internal inductances. 
L_S	Internal Source Inductance	—	8.7	—		
C_{iss}	Input Capacitance	—	1300	—	pF	$V_{GS} = 0V$, $V_{DS} = 25V$ $f = 1.0$ MHz See Fig. 5
C_{oss}	Output Capacitance	—	310	—		
C_{rss}	Reverse Transfer Capacitance	—	120	—		
C_{DC}	Drain-to-Case Capacitance	—	12	—		



Source-Drain Diode Ratings and Characteristics

Parameter	Min.	Typ.	Max.	Units	Test Conditions
I_S Continuous Source Current (Body Diode)	—	—	8.0	A	Modified MOSFET symbol showing the integral Reverse p-n junction rectifier. 
I_{SM} Pulsed Source Current (Body Diode) ①	—	—	32		
V_{SD} Diode Forward Voltage	—	—	1.5	V	$T_J = 25^\circ\text{C}$, $I_S = 8.0\text{A}$, $V_{GS} = 0\text{V}$ ④
t_{rr} Reverse Recovery Time	—	—	700	nS	$T_J = 25^\circ\text{C}$, $I_F = 8.0\text{A}$, $dI/dt \leq 100 \text{ A}/\mu\text{s}$ ④
Q_{RR} Reverse Recovery Charge	—	—	8.9	μC	$V_{DD} \leq 50\text{V}$
t_{on} Forward Turn-On Time	Intrinsic turn-on time is negligible. Turn-on speed is substantially controlled by $L_S + L_D$.				

Thermal Resistance

Parameter	Min.	Typ.	Max.	Units	Test Conditions
R_{thJC} Junction-to-Case	—	—	1.0	K/W ⑤	
R_{thCS} Case-to-Sink	—	0.21	—		Mounting surface flat, smooth, and greased
R_{thJA} Junction-to-Ambient	—	—	48		Typical socket mount

① Repetitive Rating; Pulse width limited by maximum junction temperature (see figure 9) Refer to current HEXFET reliability report

② @ $V_{DD} = 50\text{V}$, Starting $T_J = 25^\circ\text{C}$, $L \geq 20 \text{ mH}$, $R_G = 25\Omega$, Peak $I_L = 8.0\text{A}$

③ $I_{SD} \leq 8.0\text{A}$, $dI/dt \leq 100 \text{ A}/\mu\text{s}$, $V_{DD} \leq BV_{DSS}$, $T_J \leq 150^\circ\text{C}$ Suggested $R_G = 9.1\Omega$

④ Pulse width $\leq 300 \mu\text{s}$; Duty Cycle $\leq 2\%$

⑤ $K/W = ^\circ\text{C}/\text{W}$
 $W/K = \text{W}/^\circ\text{C}$

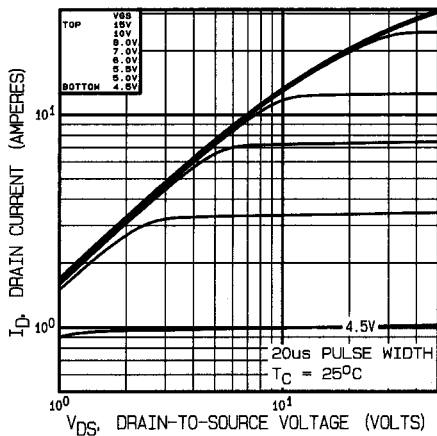

Fig. 1 — Typical Output Characteristics, $T_C = 25^\circ\text{C}$

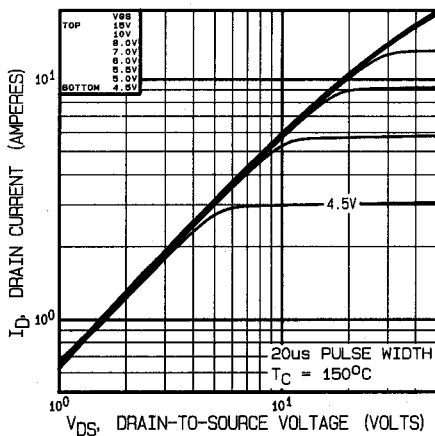

Fig. 2 — Typical Output Characteristics, $T_C = 150^\circ\text{C}$

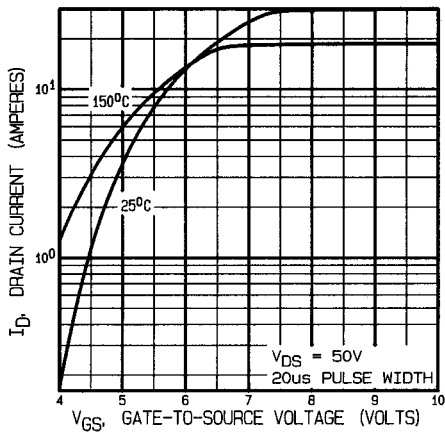

Fig. 3 — Typical Transfer Characteristics

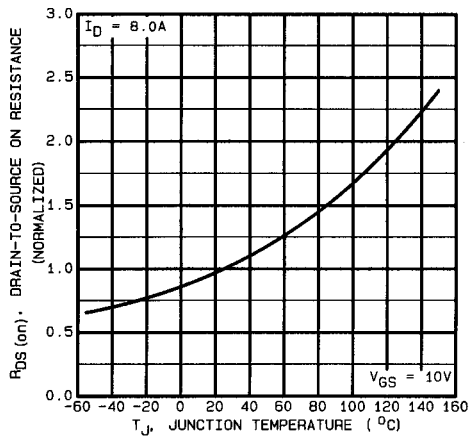

Fig. 4 — Normalized On-Resistance Vs. Temperature

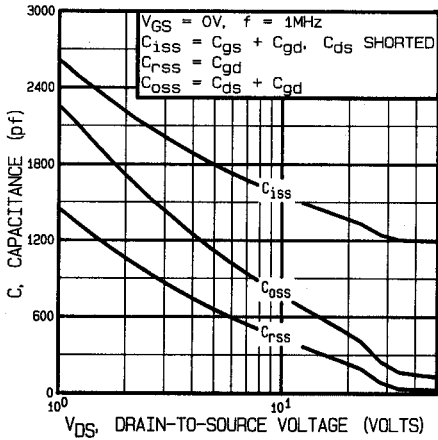

Fig. 5 — Typical Capacitance Vs. Drain-to-Source Voltage

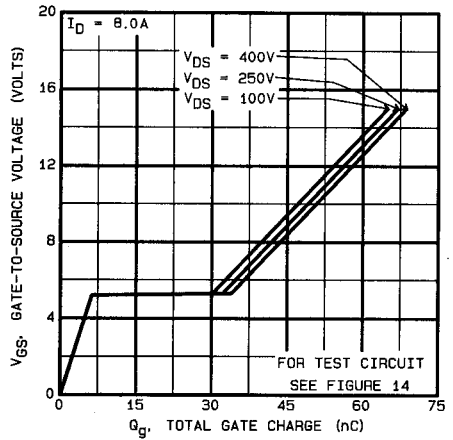

Fig. 6 — Typical Gate Charge Vs. Gate-to-Source Voltage

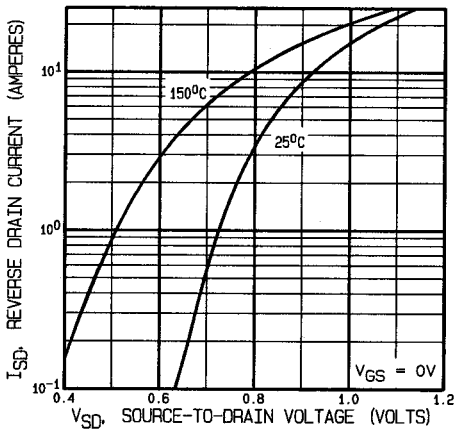

Fig. 7 — Typical Source-Drain Diode Forward Voltage

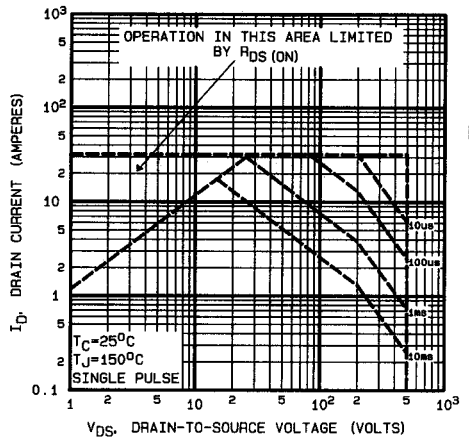

Fig. 8 — Maximum Safe Operating Area

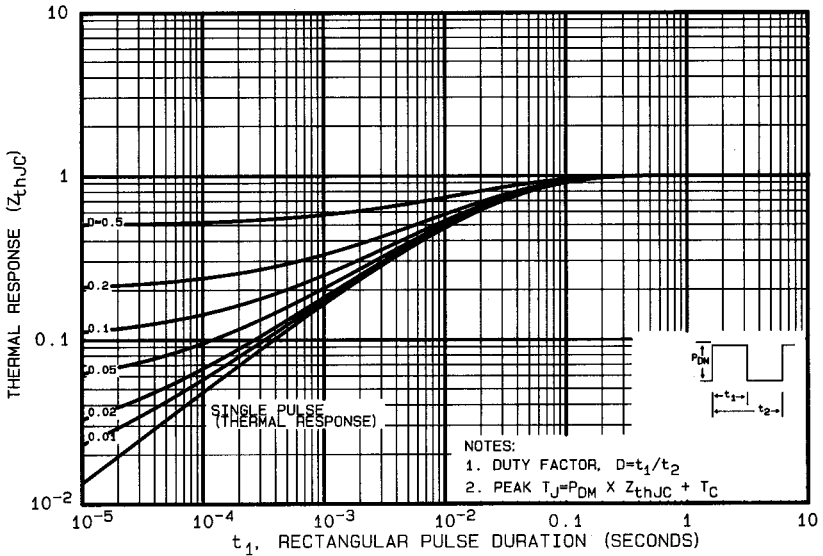

Fig. 9 — Maximum Effective Transient Thermal Impedance, Junction-to-Case Vs. Pulse Duration

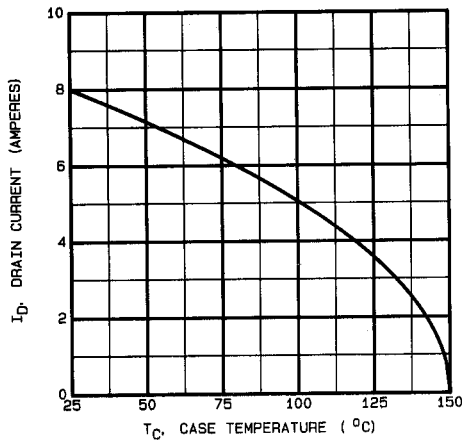

Fig. 10 — Maximum Drain Current Vs. Case Temperature

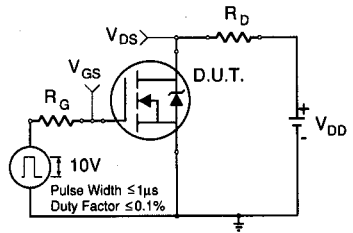

Fig. 11a — Switching Time Test Circuit

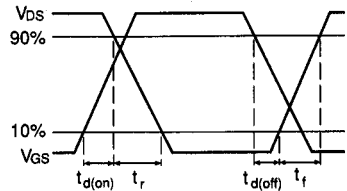

Fig. 11b — Switching Time Waveforms

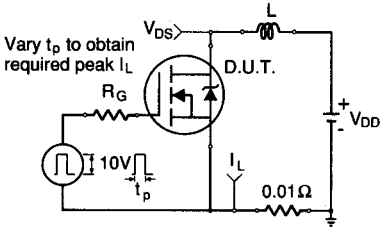

Fig. 12a — Unclamped Inductive Test Circuit

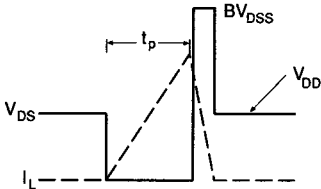

Fig. 12b — Unclamped Inductive Waveforms

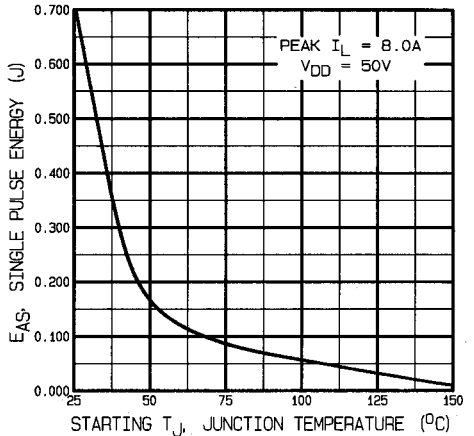

Fig. 12c — Maximum Avalanche Energy Vs. Starting Junction Temperature

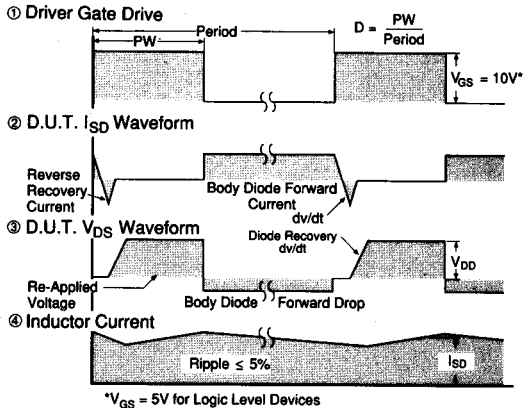
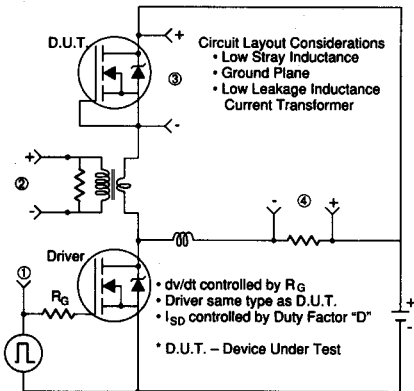

Fig. 13 — Peak Diode Recovery dv/dt Test Circuit

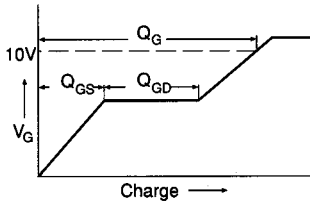

Fig. 14a — Basic Gate Charge Waveform

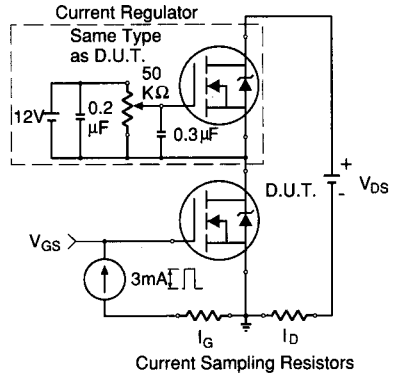

Fig. 14b — Gate Charge Test Circuit

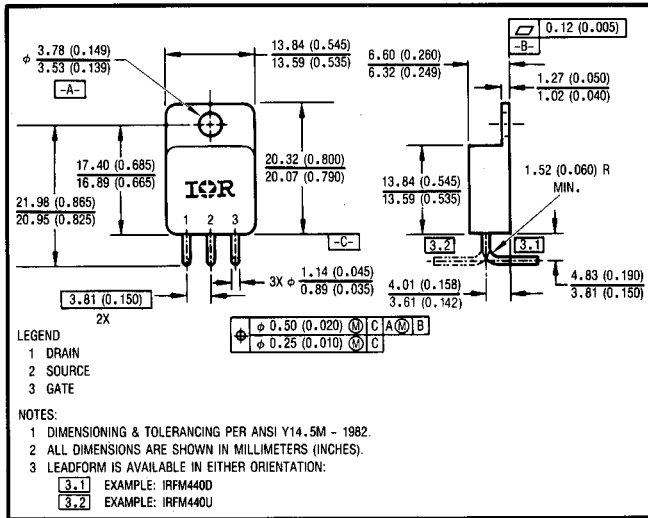

Fig. 15 — Optional Leadforms for Outline TO-254

BERYLLIA WARNING PER MIL-S-19500

Packages containing beryllia shall not be ground, sandblasted, machined, or have other operations performed on them which will produce beryllia or beryllium dust. Furthermore, beryllium oxide packages shall not be placed in acids that will produce fumes containing beryllium.